

PRODUCT MANUAL

BATHROOM



HEALTHCARE



FLOW CONTROL



Symbols



Con-Serv symbols are designed to give assistance to architects, retailers and consumers in selecting the most suitable option/s when purchasing grab rails, showers, shower seats and flow valves. They are particularly relevant when selecting items for installation in accessible sanitary facilities where Australian Standards are being implemented, when Changing Places accreditation is required, and when water flow rates are critical. The symbols below are used throughout this Product Manual as a quick and easy reference guide during the planning and purchasing process.

Symbol	Definition
	BIOMASTER Biomaster is an industry leader in antimicrobial protection offering superior protection against harmful bacteria such as Campylobacter, E.coli, Salmonella and Listeria. Check for this icon when you need antimicrobial protection.
	BARIATRIC This symbol confirms the grab rail as represented is manufactured with a pre-formed 78mm snap on domed cover and complies with <i>Section 14 Grabrails of AS 1428.1:2021 Design for access and mobility.</i>
	CLAM® FLANGE This symbol confirms the grab rail as represented is manufactured with a pre-formed 78mm snap on domed cover and complies with <i>Section 14 Grabrails of AS 1428.1:2021 Design for access and mobility.</i>
	HYGIENIC SEAL® This symbol confirms the grab rail is manufactured with Con-Serv's own Hygienic Seal® 50mm flange with Biomaster Thermoplastic Elastomer fitted seals. Hygienic Seal® grab rails comply with <i>Section 14 Grabrails of AS 1428.1:2021.</i>
	LINEAR This symbol confirms the grab rail as represented is manufactured with Con-Serv's "T" leg Linear flange with Biomaster Thermoplastic Elastomer fitted seals. Linear grab rails comply with <i>Section 14 Grabrails of AS 1428.1:2021.</i>
	FULL PATTERN SPRAY This symbol denotes that the shower head or handpiece has a single spray pattern and no adjustability.
	MULTI-FUNCTION SPRAY This symbol denotes that the shower head or handpiece has three adjustable spray patterns. Con-Serv multi-function spray patterns include Soft; Pulsating and Bubble spray.

Symbol	Definition
	BARIATRIC LOAD RATING This symbol when exhibited, displays the maximum weight capacity of an item. Ratings may vary between items and the maximum capacity is listed on the icon. E.g. The icon used in this table represents a maximum load rating of 400kg.
	ACCESSIBLE COMPLIANT This symbol when exhibited, confirms that the grab rail complies with <i>Section 12.2 Accessible Unisex Sanitary Facilities of AS 1428.1:2021 Design for access and mobility.</i>
	AMBULANT TOILET COMPLIANT This symbol when exhibited, confirms that the grab rail complies with <i>Section 13 Sanitary compartment for people with ambulant disabilities of AS 1428.1:2021 Design for access and mobility.</i>
	CHANGING PLACES This symbol when exhibited, confirms that the item meets the requirements outlined in the <i>Changing Places Design Specifications 2020.</i>
	DIMENSIONAL COMPLIANT This symbol when exhibited confirms that the item complies with the dimensional requirements of <i>AS 1428.1:2021 Design for access and mobility</i> for installation where applicable to water closets and 2 walled shower enclosure.
	PAPER ZONE COMPLIANT This symbol when exhibited confirms that the item complies with the positional requirements of <i>Section 12 Sanitary facilities of AS 1428.1:2021 Design for access and mobility.</i>
	WATERMARK WaterMark is a certification mark provided by independent certifying authorities. It confirms the product complies with the Plumbing Code and meets relevant Australian Standards relating to product quality, including health and safety.
	WATER EFFICIENCY LABELLING (WELS) The water rating label will tell you how much water that a product will use per minute, per flush or per load. The label is designed to help consumers make informed choices about the water efficiency of products they are buying.

BATHROOMS

BATHROOM ACCESSORIES

Modena Collection.....	6
Comfort Collection.....	8
Bathroom Baskets.....	11

SHOWERS

Overhead Showers.....	13
<i>Paddington</i>	13
<i>Streamjet™</i>	14
<i>Streamjet™ XL</i>	15
<i>Cosmic</i>	16
<i>Quewb</i>	18
<i>Rainstorm</i>	20
Tamper and Vandal Resistant Showers.....	21
Handheld Showers.....	22
<i>Comfort Rail</i>	22
<i>Crystal Rail</i>	23
<i>Wall Outlet Bracket</i>	24
<i>For Rails Only</i>	25
<i>Polar Rail</i>	26
<i>Riviera Rail</i>	27
<i>Antonio Rail</i>	28
<i>Quewb Rail</i>	29
Combination Showers.....	30
<i>Twin Waters™</i>	30

SPARE PARTS

Elbows and Brackets.....	32
Rails and Flanges.....	33
Shower Arms.....	34
Sliders and Accessories.....	35
Shower Handpieces.....	36
Shower Hoses.....	38
Shower Hose Parts.....	39
Switchcock Valve.....	39
Hose Restrictor Bracket.....	39
Hob Mount Set.....	39

FLOW CONTROL

Aerators.....	42
Flow Valves.....	45
<i>Control Valves, Regulators and Spigots</i>	45
<i>Dual Check/Non-Return Valves</i>	46
<i>Flood Stop Valves</i>	46
Meter-Beater® Tap Components.....	47
Measuring Devices.....	47

SAFE-ASSIST HEALTHCARE

Anti-Ligature Collection.....	50
<i>Anti-Ligature Grab Rails</i>	50
<i>Anti-Ligature Shower Kits</i>	51
Antimicrobial Collection.....	52
Backrests - Accessible Toilet Assist.....	54
Bariatric Collection.....	56
<i>Bariatric Grab Rails</i>	56
<i>Bariatric Shower Kits</i>	58
<i>Bariatric Shower Seat</i>	59
<i>Bariatric Tiltlock®</i>	59
Clam® Flange Collection.....	60
<i>Clam® Flange Grab Rails</i>	60
<i>Clam® Flange Shower Kits</i>	63
Hygienic Seal® Collection.....	66
<i>Hygienic Seal® Grab Rails</i>	66
<i>Hygienic Seal® Shower Kits</i>	72
Linear Collection.....	80
<i>Linear Grab Rails</i>	80
<i>Linear Shower Kits</i>	82
<i>Linear Twin Waters™</i>	84
Shower Seats.....	88
Folding, Swing and Floor/Wall Grab Rails.....	90
<i>Tiltlock® Folding Grab Rails</i>	90
<i>Swinglock® Grab Rails</i>	91
<i>Floor/Wall Mounted Grab Rail</i>	91
<i>Lift-N-Lock™ Grab Rail</i>	91
Spare Parts and Accessories.....	92
<i>Grab Rail Accessories</i>	92
<i>Mounting Systems</i>	93
<i>Hose Restrictor Bracket</i>	94
<i>Sliders and Accessories</i>	94
<i>Rails with Sliders</i>	95
<i>Shower Kits</i>	96
AS 1428.1:2021 Combination Kits.....	102
<i>Accessible Sanitary Facilities</i>	102
<i>Accessible Shower Recess</i>	104
<i>Accessible Combined Sanitary Facilities</i>	106
<i>Ambulant Accessible Compartments</i>	108

TECHNICAL INFORMATION

Care and Maintenance.....	111
Index.....	112
Notes.....	120
Certification and Licencing.....	123



About Con-Serv

The Con-Serv story began in 1979, when our founding director Gary Harland pioneered a water efficient shower head, that could withstand the harsh Australian environment, and conserve Australia's most valuable liquid asset. . . water. Although he didn't realise it at the time, Gary had developed something that would be seen as the foundation for today's WELS scheme.

In 1982, Gary incorporated the company to trade as Con-Serv Corporation Australia Pty Ltd, and diversified to better service the plumbing and construction industries introducing bathroom accessories, healthcare and plumbing products. By 1986, Con-Serv had enough production capacity to start distributing products throughout Australia. This is when Con-Serv truly became a widely adopted brand by architects, plumbers and renovators.

Today, the range is as strong as ever consisting of over 2,500 products across three different categories. Con-Serv continue to lead the industry with innovative solutions that push boundaries without compromising the values of quality, efficiency and sustainability we were founded on. Con-Serv have no plans on slowing down and are excited to introduce new products in our 2022 Product Manual which include new and extended product ranges, and a wider selection of sizes and finishes.

Bathroom Accessories

Con-Serv Bathroom Accessories are second to none offering superior style, quality and functionality.

Good storage and well-placed bathroom accessories are a must in every bathroom helping to remove clutter from prime real estate areas such as counter tops and shower recess areas. Here are a few tips to help with your next purchase.

Towel Rails Ensure you have the correct size towel rail for the number of towels you hang. This will help them dry faster too!

Bathroom Shelves Perfect in the shower, or above the vanity. Keeping everyday items at arm's length will help speed up your time in the bathroom, and free up your counter top.

Bathroom Baskets Super handy for storing items of all shapes and sizes, Con-Serv have a range of sizes for flexible options that will adapt to your needs.

Robe Hooks Apart from the obvious, this versatile accessory can be used to hold additional towels, clothes, appliances – just about anything!

[See our full range of Bathroom Accessories pages 6-12.](#)

Overhead Showers

From modern minimalist designs to vandal proof functionality, our overhead shower range offers a selection of shower arms that can be combined with any of our water saving shower heads to create the perfect overhead shower for your lifestyle.

Ceiling Showers

Our ceiling shower range offers both striking geometric forms and traditional shower designs featuring the best in water conservation technology. Choose from our Cosmic, Quewb and new Rainstorm shower heads.

Wall Showers

Con-Serv has perfected water saving technology to provide you with its diverse collection of fixed wall showers designed to complement our extensive selection of shower arms. Choose from our Paddington, Streamjet™ and Streamjet™ XL shower heads.

Tamper Proof Showers

Our vandal and tamper proof showers have been developed to enhance safety and security in commercial and public bathrooms. Manufactured with heavy-duty materials, our range is available in WELS 3 Star 9L/min and 4 Star 6.5L/min options.

[See our full range of Overhead Showers pages 13-21.](#)

Handheld Showers

A soothing water odyssey is yours with Con-Serv handheld showers. Minimalist beauty and high performance come together to create a variety of contemporary showers offering total rejuvenation while utilising the best in water conservation technology.

Mix and match Con-Serv showering components to create your customised showering experience. Choose from slide rails with easy to adjust friction sliders that accommodate various heights, and standard wall mounting brackets for a more traditional, minimalist handheld shower.

Select your handpiece from our Breeze, Streamjet™, Streamjet™ Turbo, Streamjet™ XL, Streamjet™ XL Turbo or Princess handpieces which are all WELS 3 Star 9L/min. Our Streamjet™ handpiece is also available in a 4 Star 6.5L/min option.

Con-Serv's collection of handheld showers are available in a variety of finishes* including Brushed Nickel, Chrome, Matte Black or White. All Con-Serv handheld showers include a dual check/non-return valve for protection against backflow contamination.

See our full range of Handheld Showers pages 22-29.

**Not all finishes are available in every range.*



Twin Waters™ - Combination Showers

Enjoy the best of both worlds with our dual outlet Twin Waters™ shower system that combines traditional overhead shower luxury with the flexibility of a handheld shower.

Connection options support installation for both top and bottom inlets allowing you to easily convert your bath or shower into a combination shower that will enhance any bathroom.

Available with our Cosmic or Quewb overhead shower rose, you can select your handpiece from our Breeze, Streamjet™, Streamjet™ Turbo, Streamjet™ XL, Streamjet™ XL Turbo or Princess which are all WELS 3 Star 9L/min. Our Streamjet™ handpiece is also available in a 4 Star 6.5L/min option.

See our full range of Twin Waters™ Combination Showers pages 30-31.



Spare Parts

Genuine Parts

We are proud of the Con-Serv range and we design every part that goes into our product. Whether you are renovating, installing, or repairing your bathroom, we have the authentic accessory or part to do the job.

See our full range of genuine Spare Parts pages 32-39.

Quality Guaranteed

All Con-Serv products are covered by our 20 year domestic or 7 year commercial warranty. Should you need more information about our warranty, contact our team on (07) 3630 5744 or visit our website www.con-serv.com.au/warranty.







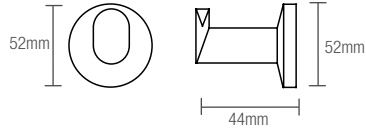

BATHROOMS

Bathroom Accessories	6
<i>Modena Collection</i>	6
<i>Comfort Collection</i>	8
<i>Bathroom Baskets</i>	11
Overhead Showers	13
<i>Paddington</i>	13
<i>Streamjet™</i>	14
<i>Streamjet™ XL</i>	15
<i>Cosmic</i>	16
<i>Quewb</i>	18
<i>Rainstorm</i>	20
Tamper and Vandal Resistant Showers	21

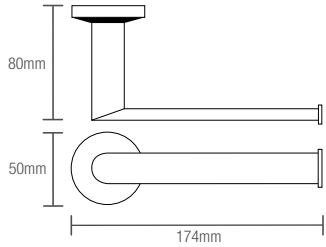
Handheld Showers	22
<i>Comfort Rail</i>	22
<i>Crystal Rail</i>	23
<i>Wall Outlet Bracket</i>	24
<i>For Rails Only</i>	25
<i>Polar Rail</i>	26
<i>Riviera Rail</i>	27
<i>Antonio Rail</i>	28
<i>Quewb Rail</i>	29
Combination Showers	30
<i>Twin Waters™</i>	30
Spare Parts	32

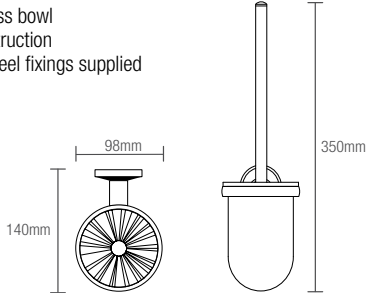

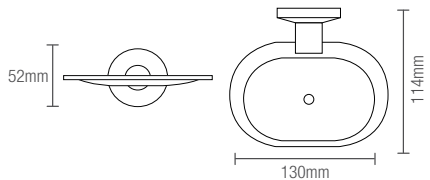

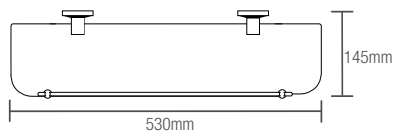

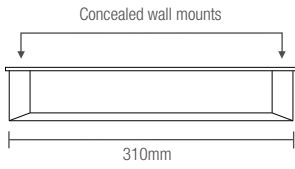

BATHROOM ACCESSORIES MODENA COLLECTION

Quality accessories combining modern materials with classic design elements to create a stylish and sleek finish that will bring your bathroom to life. It is a popular choice amongst interior designers due to the high quality brass construction and timeless chrome finish.

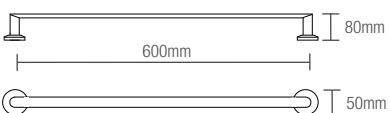
	Code	Finish	Features	
MODENA ROBE HOOK SINGLE				
	BA 115 C	Chrome	<ul style="list-style-type: none"> • Brass construction • Stainless steel fixings supplied 	
MODENA TOILET PAPER HOLDER				
	BA 112 C	Chrome	<ul style="list-style-type: none"> • Brass construction • Stainless steel fixings supplied 	
MODENA TOILET BRUSH WITH HOLDER				
	BA 114 C	Chrome	<ul style="list-style-type: none"> • Wall mounted toilet brush • Frosted glass bowl • Brass construction • Stainless steel fixings supplied 	
	SPARE PARTS			
	BA 714 FR GO	Glass only		
	BA 714 WT BO	Brush head only		
	BA 714 C BH	Handle only		
MODENA SOAP DISH HOLDER				
	BA 101 C	Chrome	<ul style="list-style-type: none"> • Brass construction • Stainless steel fixings supplied 	
MODENA GLASS SHELF				
	BA 108 C	Chrome	<ul style="list-style-type: none"> • 530mm shelf with barrier • 10mm clear tempered glass • Brass construction • Stainless steel fixings supplied 	
	SPARE PARTS			
	BA 729 C BO	Barrier only		

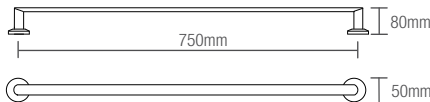
BATHROOM ACCESSORIES MODENA COLLECTION

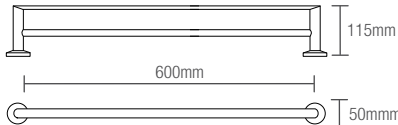
Quality accessories combining modern materials with classic design elements to create a stylish and sleek finish that will bring your bathroom to life. It is a popular choice amongst interior designers due to the high quality brass construction and timeless chrome finish.

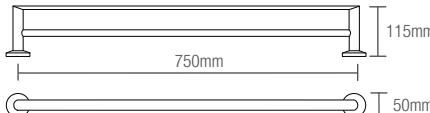





	Code	Finish	Features
MODENA HAND TOWEL RAIL			
	BA 111 C	Chrome	<ul style="list-style-type: none"> • 280mm, centre to centre • Brass construction • Stainless steel fixings supplied
			
MODENA TOWEL RAIL SINGLE 600MM			
	BA 104 C	Chrome	<ul style="list-style-type: none"> • 600mm, centre to centre • Brass construction • Stainless steel fixings supplied
			
MODENA TOWEL RAIL SINGLE 750MM			
	BA 105 C	Chrome	<ul style="list-style-type: none"> • 750mm, centre to centre • Brass construction • Stainless steel fixings supplied
			
MODENA TOWEL RAIL DOUBLE 600MM			
	BA 106 C	Chrome	<ul style="list-style-type: none"> • 600mm, centre to centre • Brass construction • Stainless steel fixings supplied
			
MODENA TOWEL RAIL DOUBLE 750MM			
	BA 107 C	Chrome	<ul style="list-style-type: none"> • 750mm, centre to centre • Brass construction • Stainless steel fixings supplied
			

BATHROOM ACCESSORIES

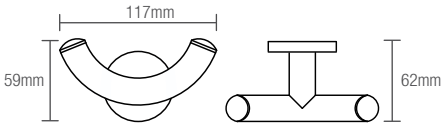
COMFORT COLLECTION

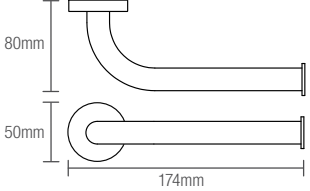

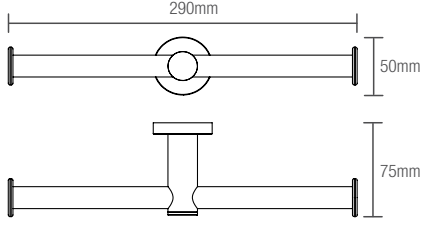
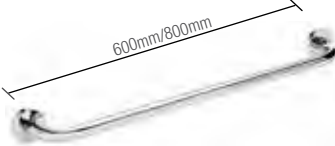
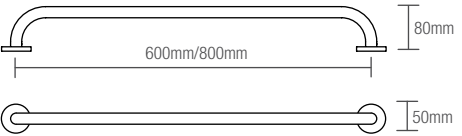
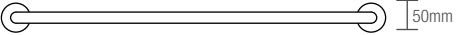

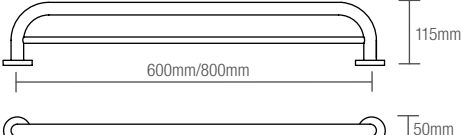
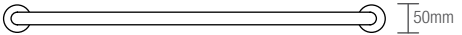

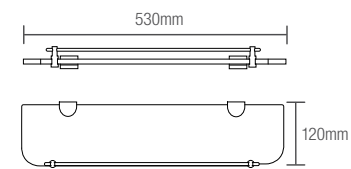

Our most popular range, the Comfort Collection features sleek European designs that will stand the test of time. Simple geometric forms with rounded edges enhance the aesthetics while ensuring safety. This comprehensive range is crafted from quality materials for long-lasting looks and durability.

Code Finish Features

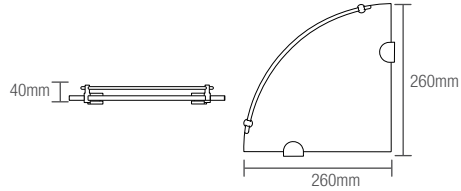
COMFORT ROBE HOOK DOUBLE			
	BA 715 BN	Brushed Nickel	<ul style="list-style-type: none"> • Brass construction • Stainless steel fixings supplied
	BA 715 C	Chrome	
	BA 715 MB	Matte Black	
			
COMFORT TOILET PAPER HOLDER			
	BA 712 BN	Brushed Nickel	<ul style="list-style-type: none"> • Brass construction • Stainless steel fixings supplied
	BA 712 C	Chrome	
	BA 712 MB	Matte Black	
			
COMFORT TOILET PAPER HOLDER DOUBLE			
	BA 722 C	Chrome	<ul style="list-style-type: none"> • Brass construction • Stainless steel fixings supplied
			
COMFORT TOWEL RAIL SINGLE			
	600MM		<ul style="list-style-type: none"> • 600mm and 800mm, centre to centre, 20mm rail • Brass construction • Stainless steel fixings supplied
	BA 704 C	Chrome	
	800MM		
	BA 705 C	Chrome	
			
COMFORT TOWEL RAIL DOUBLE			
	600MM		<ul style="list-style-type: none"> • 600mm and 800mm, centre to centre, 20mm rail • Brass construction • Stainless steel fixings supplied
	BA 706 C	Chrome	
	800MM		
	BA 707 C	Chrome	
			

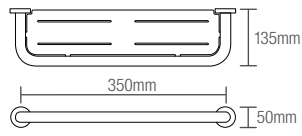
BATHROOM ACCESSORIES COMFORT COLLECTION

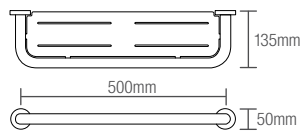

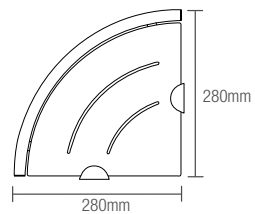



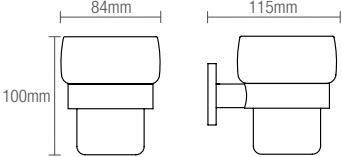

Our most popular range, the Comfort Collection features sleek European designs that will stand the test of time. Simple geometric forms with rounded edges enhance the aesthetics while ensuring safety. This comprehensive range is crafted from quality materials for long-lasting looks and durability.

	Code	Finish	Features
COMFORT GLASS SHELF			
	BA 729 C	Chrome	<ul style="list-style-type: none"> • 530mm shelf with barrier • 10mm clear tempered glass • Brass construction • Stainless steel fixings supplied 
	SPARE PARTS		
	BA 729 C B0	Barrier only	
	BA 769 C	Mount brackets (2)	
COMFORT CORNER GLASS SHELF			
	BA 739 C	Chrome	<ul style="list-style-type: none"> • 260mm x 260mm shelf with barrier • 10mm clear tempered glass • Brass construction • Stainless steel fixings supplied 
	SPARE PARTS		
	BA 739 C B0	Barrier only	
	BA 769 C	Mount brackets (2)	
COMFORT STAINLESS STEEL SHELF 350MM			
	BA 710 BS	Brushed Stainless	<ul style="list-style-type: none"> • 350mm, centre to centre • Stainless steel construction • Stainless steel fixings supplied • Complies with requirements of AS 1428.1:2021 section 12.4.2 (B1) <p>Shelves within circulation space</p>  
	BA 710 MB	Matte Black	
	BA 710 PS	Polish Supreme™	
COMFORT CORNER STAINLESS STEEL SHELF 500MM			
	BA 708 BS	Brushed Stainless	<ul style="list-style-type: none"> • 500mm, centre to centre • Stainless steel construction • Stainless steel fixings supplied • Complies with requirements of AS 1428.1:2021 section 12.4.2 (B2) <p>Shelves external to circulation space</p>  
	BA 708 MB	Matte Black	
	BA 708 PS	Polish Supreme™	
COMFORT CORNER STAINLESS STEEL SHELF			
	BA 718 BS	Brushed Stainless	<ul style="list-style-type: none"> • 280mm x 280mm radius • Stainless steel construction • Floating mount brackets • Stainless steel fixings supplied 
	BA 718 PS	Polish Supreme™	

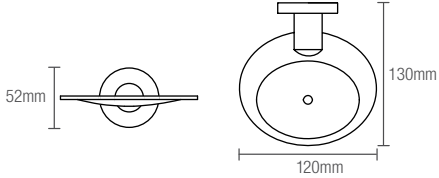
Rounded Safety Edge

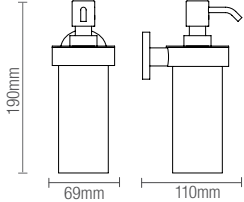
BATHROOM ACCESSORIES COMFORT COLLECTION

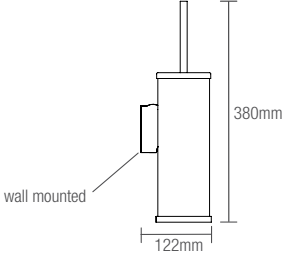
Our most popular range, the Comfort Collection features sleek European designs that will stand the test of time. Simple geometric forms with rounded edges enhance the aesthetics while ensuring safety. This comprehensive range is crafted from quality materials for long-lasting looks and durability.

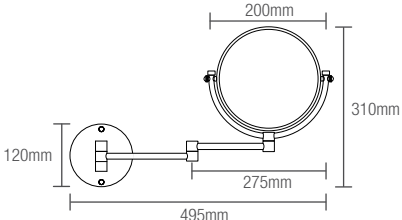
	Code	Finish	Features
COMFORT TUMBLER HOLDER			
	BA 700 C	Chrome	<ul style="list-style-type: none"> • Wall mounted tumbler holder • Frosted glass tumbler • Brass construction • Stainless steel fixings supplied 
	SPARE PART		
	BA 700 FR GO	Glass only	
COMFORT SOAP DISH HOLDER			
	BA 701 C	Chrome	<ul style="list-style-type: none"> • Brass construction • Stainless steel fixings supplied 
COMFORT WALL MOUNTED SOAP HOLDER			
	BA 742 C	Chrome	<ul style="list-style-type: none"> • Brass construction • Stainless steel fixings supplied 
COMFORT WALL MOUNTED TOILET BRUSH WITH HOLDER			
	BA 750 C	Chrome	<ul style="list-style-type: none"> • Brass construction • Stainless steel fixings supplied 
COMFORT MIRROR DUAL SIDED			
	BA 780 C	Chrome	<ul style="list-style-type: none"> • Wall mounted with double swivel arm • Normal and 3x magnification • Brass construction • Stainless steel fixings supplied 

BATHROOM ACCESSORIES COMFORT COLLECTION











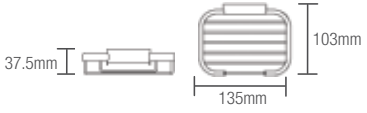

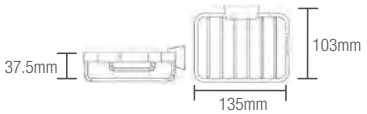
Our most popular range, the Comfort Collection features sleek European designs that will stand the test of time. Simple geometric forms with rounded edges enhance the aesthetics while ensuring safety. This comprehensive range is crafted from quality materials for long-lasting looks and durability.

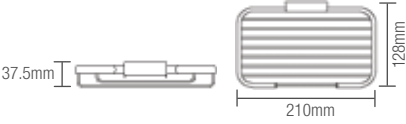
	Code	Finish	Features
COMFORT LIFESTYLE RAIL			
	300MM		<ul style="list-style-type: none"> • Straight support rail • Constructed from 25mm stainless steel for enhanced support • Mount vertically or horizontally • Concealed fixings • Stainless steel fixing screws supplied • Available in 300mm, 450mm, 600mm and 900mm rails • Custom finishes available P.O.A.
	CR 300 BS	Brushed Stainless	
	CR 300 MB	Matte Black	
	CR 300 PS	Polish Supreme™	
	450MM		
	CR 450 BS	Brushed Stainless	
	CR 450 MB	Matte Black	
	CR 450 PS	Polish Supreme™	
	600MM		
	CR 600 BS	Brushed Stainless	
	CR 600 MB	Matte Black	
	CR 600 PS	Polish Supreme™	
	900MM		
	CR 900 BS	Brushed Stainless	
CR 900 MB	Matte Black		
CR 900 PS	Polish Supreme™		
COMFORT SHOWER FOOTREST			
	BA 719 C	Chrome	<ul style="list-style-type: none"> • Polycarbonate/ABS corner footrest • Concealed fixings • Must be fitted to a solid wall • 1½" x 10G stainless steel screws and wall plugs supplied Max. 70kg load bearing
COMFORT CLOTHES LINE RETRACTABLE			
	BA 782 C	Chrome	<ul style="list-style-type: none"> • 2500mm (maximum) retractable cord extension • Brass construction • Stainless steel fixings supplied
COMFORT CORNER BASKET LARGE			
	BB 017 C	Chrome	<ul style="list-style-type: none"> • Concealed fixings • Stainless steel fixings supplied
	BB 017 MB	Matte Black	
COMFORT RECTANGULAR BASKET LARGE			
	BB 011 C	Chrome	<ul style="list-style-type: none"> • Concealed fixings • Stainless steel fixings supplied
	BB 011 MB	Matte Black	

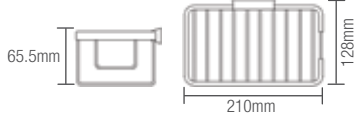
BATHROOM ACCESSORIES

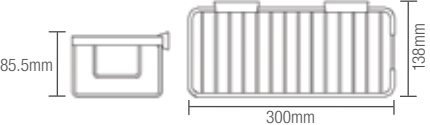
BATHROOM BASKETS

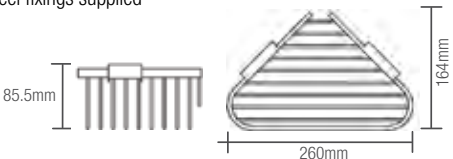
Add some finishing touches to your bathroom with Con-Serv's Bathroom Basket range. Constructed using heavy chrome plated brass, all Con-Serv Bathroom Baskets have innovative concealed fixings and are built to last.

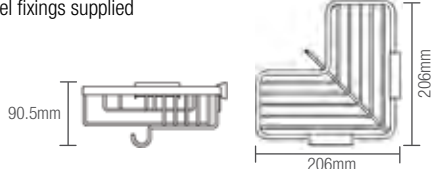
	Code	Finish	Features
RECTANGULAR BASKET SMALL			
	WB 003 C	Chrome	<ul style="list-style-type: none"> • Brass construction • Concealed fixings • Stainless steel fixings supplied 
OPEN FRONT RECTANGULAR BASKET SMALL			
	WB 005 C	Chrome	<ul style="list-style-type: none"> • Brass construction • Concealed fixings • Stainless steel fixings supplied 
OPEN FRONT RECTANGULAR BASKET MEDIUM			
	WB 004 C	Chrome	<ul style="list-style-type: none"> • Brass construction • Concealed fixings • Stainless steel fixings supplied 
RECTANGULAR BASKET MEDIUM			
	WB 002 C	Chrome	<ul style="list-style-type: none"> • Brass construction • Concealed fixings • Stainless steel fixings supplied 
RECTANGULAR BASKET LARGE			
	WB 001 C	Chrome	<ul style="list-style-type: none"> • Brass construction • Concealed fixings • Stainless steel fixings supplied 
CORNER BASKET SMALL			
	WB 008 C	Chrome	<ul style="list-style-type: none"> • Brass construction • Concealed fixings • Stainless steel fixings supplied 
CORNER BASKET MEDIUM			
	WB 006 C	Chrome	<ul style="list-style-type: none"> • Brass construction • Concealed fixings • Stainless steel fixings supplied 

OVERHEAD SHOWERS PADDINGTON

Domed ABS 150mm shower rose with rub-clean diffuser in a traditional single pattern spray. Suited to difficult pressure applications, gravity fed tanks and instantaneous heaters. All Con-Serv Paddington showers are 3 Star 9L/min as per WELS licence number 0046.

	Code	Finish	Features
PADDINGTON ROSE ONLY			
	OH 005A C	Chrome	<ul style="list-style-type: none"> • ABS 150mm domed shower rose with rub-clean spray diffuser • Full pattern spray • WaterMark AS 3662 WMKT 21147 • 3 Star 9L/min as per WELS licence number 0046 
PADDINGTON SWAN NECK RISING ARM			
	OH 005E C	Chrome	<ul style="list-style-type: none"> • ABS 150mm domed shower rose with rub-clean spray diffuser • Brass 290mm rising arm with flow Interchange® spigot • Brass 57mm wall flange • Full pattern spray • WaterMark AS 3662 WMKT 21147 • 3 Star 9L/min as per WELS licence number 0046 
PADDINGTON HORIZONTAL ARM			
	OH 005H C	Chrome	<ul style="list-style-type: none"> • ABS 150mm domed shower rose with rub-clean spray diffuser • 316 stainless steel 450mm horizontal fixed arm with flow Interchange® spigot • Ball joint mounted • ½" BSP female connection to wall outlet ½" BSP male thread for shower connection • Stainless steel 62mm wall flange • Full pattern spray • WaterMark AS 3662 WMKT 21147 • 3 Star 9L/min as per WELS licence number 0046 
PADDINGTON CLICKLOCK™ ORBITAL/ADJUSTABLE ARM			
	OH 005D C	Chrome	<ul style="list-style-type: none"> • ABS 150mm domed shower rose with rub-clean spray diffuser • Brass 300mm orbital/adjustable arm with flow Interchange® spigot • Brass 57mm wall flange • Full pattern spray • WaterMark AS 3662 WMKT 21147 • 3 Star 9L/min as per WELS licence number 0046 
PADDINGTON VERTICAL ARM			
 <p>150mm/300mm 450mm/600mm</p>	OH 005T C	Chrome 150mm	<ul style="list-style-type: none"> • ABS 150mm domed shower rose with rub-clean spray diffuser • Ball joint mounted to 316 stainless steel vertical fixed arm with flow Interchange® spigot • ½" BSP shower connection (Female to Male) • Stainless steel 62mm wall flange • Full pattern spray • WaterMark AS 3662 WMKT 21147 • 3 Star 9L/min as per WELS licence number 0046 • Available in 150mm, 300mm, 450mm and 600mm arms • Custom lengths available on request P.O.A. 
	OH 005U C	Chrome 300mm	
	OH 005W C	Chrome 450mm	
	OH 005X C	Chrome 600mm	

OVERHEAD SHOWERS STREAMJET™

A contemporary ABS 100mm shower rose with concentric single pattern jet spray diffuser producing a rich full pattern spray for a dense shower experience. Streamjet™ overhead showers are available in 3 Star 9L/min and 4 Star 6.5L/min as per WELS licence number 0046.



	Code	Finish	Features
STREAMJET™ ROSE ONLY			
	OH 006A BN	Brushed Nickel	<ul style="list-style-type: none"> • ABS 100mm shower rose with rub-clean spray diffuser • Full pattern spray • WaterMark AS 3662 WMKT 21147 • Available in 3 Star 9L/min and 4 Star 6.5L/min as per WELS licence number 0046 
	OH 006A BN/6.5	Brushed Nickel	
	OH 006A C	Chrome	
	OH 006A C/6.5	Chrome	
	OH 006A MB	Matte Black	
	OH 006A MB/6.5	Matte Black	
	OH 006A WTC	White/Chrome	
	OH 006A WTC/6.5	White/Chrome	
STREAMJET™ UPSWEPT FIXED ARM			
	OH 006B BN	Brushed Nickel	<ul style="list-style-type: none"> • ABS 100mm shower rose with rub-clean spray diffuser • Brass 150mm fixed arm with flow Interchange® spigot • Brass 57mm wall flange • Chrome plated finish • Full pattern spray • WaterMark AS 3662 WMKT 21147 • Available in 3 Star 9L/min and 4 Star 6.5L/min as per WELS licence number 0046 
	OH 006B BN/6.5	Brushed Nickel	
	OH 006B C	Chrome	
	OH 006B C/6.5	Chrome	
	OH 006B MB	Matte Black	
	OH 006B MB/6.5	Matte Black	
	OH 006B WTC	White/Chrome	
	OH 006B WTC/6.5	White/Chrome	
STREAMJET™ CLICKLOCK™ ORBITAL/ADJUSTABLE ARM			
	OH 006D BN	Brushed Nickel	<ul style="list-style-type: none"> • ABS 100mm shower rose with rub-clean spray diffuser • Brass 300mm orbital/adjustable arm with flow Interchange® spigot • Brass 57mm wall flange • Full pattern spray • WaterMark AS 3662 WMKT 21147 • Available in 3 Star 9L/min and 4 Star 6.5L/min as per WELS licence number 0046 
	OH 006D BN/6.5	Brushed Nickel	
	OH 006D C	Chrome	
	OH 006D C/6.5	Chrome	
	OH 006D MB	Matte Black	
	OH 006D MB/6.5	Matte Black	
	OH 006D WTC	White/Chrome	
	OH 006D WTC/6.5	White/Chrome	
STREAMJET™ SWAN NECK RISING ARM			
	OH 006E BN	Brushed Nickel	<ul style="list-style-type: none"> • ABS 100mm shower rose with rub-clean spray diffuser • Brass 290mm rising arm with flow Interchange® spigot • Brass 57mm wall flange • Full pattern spray • WaterMark AS 3662 WMKT 21147 • Available in 3 Star 9L/min and 4 Star 6.5L/min as per WELS licence number 0046 
	OH 006E BN/6.5	Brushed Nickel	
	OH 006E C	Chrome	
	OH 006E C/6.5	Chrome	
	OH 006E MB	Matte Black	
	OH 006E MB/6.5	Matte Black	
	OH 006E WTC	White/Chrome	
	OH 006E WTC/6.5	White/Chrome	
STREAMJET™ GRAND ARM			
	OH 006G C	Chrome	<ul style="list-style-type: none"> • ABS 100mm shower rose with rub-clean spray diffuser • Brass 165mm upswept arm • Full pattern spray • WaterMark AS 3662 WMKT 21147 • Available in 3 Star 9L/min and 4 Star 6.5L/min as per WELS licence number 0046 
	OH 006G C/6.5	Chrome	
	OH 006G WTC	White/Chrome	
	OH 006G WTC/6.5	White/Chrome	

OVERHEAD SHOWERS

STREAMJET™ XL

A premium extra large (XL) ABS 130mm chrome face shower rose with concentric single pattern jet spray producing a lavish rain-like spray for a soothing and relaxing shower. All Con-Serv Streamjet™ XL showers are 3 Star 9L/min as per WELS licence number 0046.

	Code	Finish	Features
STREAMJET™ XL ROSE ONLY			
	OH 008A BN	Brushed Nickel*	<ul style="list-style-type: none"> • ABS 130mm extra large shower rose with rub-clean spray diffuser • Full pattern spray • WaterMark AS 3662 WMKT 21147 • 3 Star 9L/min as per WELS licence number 0046 
	OH 008A C	Chrome	
	OH 008A MB	Matte Black*	
		*AVAILABLE JULY 2022	
STREAMJET™ XL UPSWEPT FIXED ARM			
	OH 008B BN	Brushed Nickel*	<ul style="list-style-type: none"> • ABS 130mm extra large shower rose with rub-clean spray diffuser • Brass 150mm fixed arm with flow Interchange® spigot • Brass 57mm wall flange • Chrome plated finish • Full pattern spray • WaterMark AS 3662 WMKT 21147 • 3 Star 9L/min as per WELS licence number 0046 
	OH 008B C	Chrome	
	OH 008B MB	Matte Black*	
		*AVAILABLE JULY 2022	
STREAMJET™ XL CLICKLOCK™ ORBITAL/ADJUSTABLE ARM			
	OH 008D BN	Brushed Nickel*	<ul style="list-style-type: none"> • ABS 130mm extra large shower rose with rub-clean spray diffuser • Brass 300mm orbital/adjustable arm with flow Interchange® spigot • Brass 57mm wall flange • Full pattern spray • WaterMark AS 3662 WMKT 21147 • 3 Star 9L/min as per WELS licence number 0046 
	OH 008D C	Chrome	
	OH 008D MB	Matte Black*	
		*AVAILABLE JULY 2022	
STREAMJET™ XL SWAN NECK RISING ARM			
	OH 008E BN	Brushed Nickel*	<ul style="list-style-type: none"> • ABS 130mm extra large shower rose with rub-clean spray diffuser • Brass 290mm rising arm with flow Interchange® spigot • Brass 57mm wall flange • Full pattern spray • WaterMark AS 3662 WMKT 21147 • 3 Star 9L/min as per WELS licence number 0046 
	OH 008E C	Chrome	
	OH 008E MB	Matte Black*	
		*AVAILABLE JULY 2022	
STREAMJET™ XL GRAND ARM			
	OH 008G C	Chrome	<ul style="list-style-type: none"> • ABS 130mm extra large shower rose with rub-clean spray diffuser • Brass 165mm upswept arm • Full pattern spray • WaterMark AS 3662 WMKT 21147 • 3 Star 9L/min as per WELS licence number 0046 

OVERHEAD SHOWERS COSMIC

Modern ABS 256mm rainmaker shower rose, the Cosmic can be wall or ceiling mounted. Ideal for larger shower areas, with a range of arm options to suit personal style and preferences. All Con-Serv Cosmic showers are 3 Star 9L/min as per WELS licence number 0046.



	Code	Finish	Features
COSMIC ROSE ONLY			
	OH 028A BN	Brushed Nickel	<ul style="list-style-type: none"> • ABS 256mm rainmaker shower rose with rub-clean spray diffuser • Full pattern spray • WaterMark AS 3662 WMKT 21147 • 3 Star 9L/min as per WELS licence number 0046 
	OH 028A C	Chrome	
	OH 028A MB	Matte Black	
COSMIC HORIZONTAL ARM 310MM			
	OH 028H C	Chrome	<ul style="list-style-type: none"> • ABS 256mm rainmaker shower rose with rub-clean spray diffuser • 310mm fixed arm with flow Interchange® spigot • Brass construction • Brass 57mm wall flange • ½" BSP female inlet with ½" BSP male threaded outlet • Full spray pattern • WaterMark AS 3662 WMKT 21147 • 3 Star 9L/min as per WELS licence number 0046 
	OH 028H MB	Matte Black	
COSMIC HORIZONTAL ARM 450MM			
	OH 028K BN	Brushed Nickel	<ul style="list-style-type: none"> • ABS 256mm rainmaker shower rose with rub-clean spray diffuser • 450mm extended projection horizontal arm with flow Interchange® spigot • 316 stainless steel construction for added strength • 316 stainless steel 62mm wall flange • ½" BSP female inlet with ½" BSP male threaded outlet • Full spray pattern • WaterMark AS 3662 WMKT 21147 • 3 Star 9L/min as per WELS licence number 0046 
	OH 028K C	Chrome	
	OH 028K MB	Matte Black	
COSMIC SWIVEL CRANE NECK ARM			
	OH 028Q BN	Brushed Nickel	<ul style="list-style-type: none"> • ABS 256mm rainmaker shower rose with rub-clean spray diffuser • 380mm crane neck swivelling shower arm with flow Interchange® spigot • Brass construction • Brass 57mm wall flange • ½" BSP female inlet with ½" BSP male threaded outlet • Full spray pattern • WaterMark AS 3662 WMKT 21147 • 3 Star 9L/min as per WELS licence number 0046 
	OH 028Q C	Chrome	
	OH 028Q MB	Matte Black	

OVERHEAD SHOWERS QUEWB





Stylish ABS 220mm square rainmaker shower rose with rub-clean feature and selected arm options to suit personal preferences. Ideally suited for large shower recess areas. All Con-Serv Quewb showers are 3 Star 9L/min as per WELS licence number 0046.



	Code	Finish	Features
QUEWB ROSE ONLY			
	OH 030A C	Chrome	<ul style="list-style-type: none"> • ABS 220mm rainmaker shower rose with rub-clean spray diffuser • Full pattern spray • WaterMark AS 3662 WMKT 21147 • 3 Star 9L/min as per WELS licence number 0046 
QUEWB HORIZONTAL ARM			
	OH 030H C	Chrome	<ul style="list-style-type: none"> • ABS 220mm rainmaker shower rose with rub-clean spray diffuser • 310mm fixed arm with flow Interchange® spigot • Brass construction • Brass 57mm wall flange • ½" BSP female inlet with ½" BSP male threaded outlet • Full pattern spray • WaterMark AS 3662 WMKT 21147 • 3 Star 9L/min as per WELS licence number 0046 
QUEWB SWIVEL CRANE NECK ARM			
	OH 030Q C	Chrome	<ul style="list-style-type: none"> • ABS 220mm rainmaker shower rose with rub-clean spray diffuser • 380mm crane neck swivelling shower arm with flow Interchange® spigot • Brass construction • Brass 57mm wall flange • ½" BSP female inlet with ½" BSP male threaded outlet • Full spray pattern • WaterMark AS 3662 WMKT 21147 • 3 Star 9L/min as per WELS licence number 0046 

OVERHEAD SHOWERS QUEWB

Stylish ABS 220mm square rainmaker shower rose with rub-clean feature and selected arm options to suit personal preferences. Ideally suited for large shower recess areas. All Con-Serv Quewb showers are 3 Star 9L/min as per WELS licence number 0046.

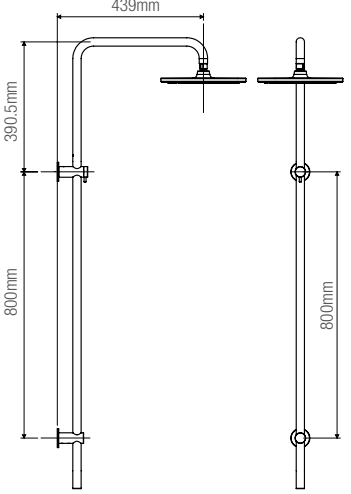
	Code	Finish	Features
QUEWB VERTICAL ARM			
	150MM		<ul style="list-style-type: none"> • ABS 220mm rainmaker shower rose with rub-clean spray diffuser • Vertical shower arm for ceiling installations • Available in lengths of 150mm, 300mm, 450mm and 600mm • Brass construction • Brass 57mm wall flange • ½" BSP female inlet with ½" BSP male threaded outlet • Full pattern spray • WaterMark AS 3662 WMKT 21147 • 3 Star 9L/min as per WELS licence number 0046 
	OH 030T C	Chrome	
	300MM		
	OH 030U C	Chrome	
	450MM		
	OH 030W C	Chrome	
600MM			
	OH 030X C	Chrome	
QUEWB OVERHEAD RAIL			
	OR 080Q C	Chrome	<ul style="list-style-type: none"> • ABS 220mm rainmaker shower rose with rub-clean spray diffuser • 800mm brass rail (TOP INLET) featuring 380mm swivel crane neck arm with flow Interchange® spigot • Brass construction • Brass 57mm wall flange • ½" BSP female inlet with ½" BSP male threaded outlet • Full pattern spray • WaterMark AS 3662 WMKT 21147 • 3 Star 9L/min as per WELS licence number 0046  

TAMPER AND VANDAL RESISTANT SHOWERS

PIONEER, ZODIAC, COBRA AND VANGUARD

For installation where vandalism is a consideration such as camping grounds, caravan parks, beaches and schools. All Con-Serv tamper and vandal resistant overhead showers are available in 3 Star 9L/min and 4 Star 6.5L/min as per WELS licence number 0046.

Code Finish Features

TAMPER RESISTANT SHOWERS

PIONEER				
	CS 008 C	Chrome	<ul style="list-style-type: none"> • Heavy-duty design • Ideal for camp-sites, caravan parks and schools • 125mm shower body with flow Interchange® spigot • Brass construction • Brass 57mm wall flange • 316 stainless steel (marine grade) 27mm jet spray diffuser • Spring tensioned (anti-droop) ball joint • Full pattern spray • WaterMark AS 3662 WMKT 21147 • Available in 3 Star 9L/min and 4 Star 6.5L/min as per WELS licence number 0046 	
	CS 008 C/6.5	Chrome		
ZODIAC				
	CS 061 C	Chrome	<ul style="list-style-type: none"> • Heavy-duty design • Ideal for camp-sites, caravan parks and schools • ABS 50mm concentric spray diffuser • 55mm arm with flow Interchange® spigot • Brass construction • Brass 57mm wall flange • Full pattern spray • WaterMark AS 3662 WMKT 21147 • 3 Star 9L/min as per WELS licence number 0046 	



VANDAL RESISTANT SHOWERS



COBRA				
	CS 007 C	Chrome	<ul style="list-style-type: none"> • Vandal resistant/Anti-ligature design • Ideal for correctional, mental health and rehabilitation centres • 17° angle design, free from ligature points and attached with grub screws for tamper resistant installation • 59mm shower body • Brass construction • 316 stainless steel (marine grade) 27mm jet spray diffuser • Full pattern spray • Maximum spray projection 940mm from 1850mm height • WaterMark AS 3662 WMKT 21147 • Available in 3 Star 9L/min and 4 Star 6.5L/min as per WELS licence number 0046 	
	CS 007 C/6.5	Chrome		
VANGUARD				
	CS 009 PS	Polish Supreme™	<ul style="list-style-type: none"> • Vandal resistant design • Ideal for high corrosion environments e.g. beach fronts • 316 stainless steel (marine grade) 65mm shower body with flow Interchange® spigot • 316 stainless steel 62mm wall flange • 27mm jet spray diffuser • Full pattern spray • WaterMark AS 3662 WMKT 21147 • Available in 3 Star 9L/min and 4 Star 6.5L/min as per WELS licence number 0046 	
	CS 009 PS/6.5	Polish Supreme™		

HANDHELD SHOWERS - COMFORT RAIL



- 900mm x 25mm stainless steel rail
- 50mm wall mount flange
- Solid brass Friction Slide Cradle
- DR brass wall outlet elbow
- DR brass 9L/min flow Interchange® spigot
- Licenced dual check/non-return valve
- 57mm solid brass round flat flange
- 1500mm PVC hose



Model Code Finish Features



STREAMJET™			
	CR 900J BN	Brushed Nickel	<ul style="list-style-type: none"> • ABS 100mm single function shower • Concentric full pattern spray • Rub-clean spray diffuser • WaterMark AS 3662 WMKT 21147 • Available in 3 Star 9L/min and 4 Star 6.5L/min as per WELS licence number 0046 
	CR 900J BN/6.5	Brushed Nickel	
	CR 900J C	Chrome	
	CR 900J C/6.5	Chrome	
	CR 900J MB	Matte Black	
	CR 900J MB/6.5	Matte Black	

STREAMJET™ TURBO PULSATOR				
	CR 900T C	Chrome	<ul style="list-style-type: none"> • ABS 100mm multi-function shower • Soft, pulsating and bubble spray functions • Rub-clean spray diffuser • WaterMark AS 3662 WMKT 21147 • Available in 3 Star 9L/min as per WELS licence number 0046 	

STREAMJET™ XL				
	CR 900X BN	Brushed Nickel*	<ul style="list-style-type: none"> • ABS 130mm single function shower • Concentric full pattern spray • Rub-clean spray diffuser • WaterMark AS 3662 WMKT 21147 • Available in 3 Star 9L/min as per WELS licence number 0046 	
	CR 900X C	Chrome		
	CR 900X MB	Matte Black*		
		*AVAILABLE JULY 2022		

STREAMJET™ XL TURBO PULSATOR				
	CR 900S C	Chrome	<ul style="list-style-type: none"> • ABS 130mm multi-function shower • Soft, pulsating and bubble spray functions • Rub-clean spray diffuser • WaterMark AS 3662 WMKT 21147 • Available in 3 Star 9L/min as per WELS licence number 0046 	

PRINCESS				
	CR 900P C	Chrome	<ul style="list-style-type: none"> • ABS 83mm arched single function shower • Full pattern spray • Rub-clean spray diffuser • WaterMark AS 3662 WMKT 21147 • Available in 3 Star 9L/min as per WELS licence number 0046 	

BREEZE				
	CR 900Z C	Chrome	<ul style="list-style-type: none"> • ABS 104mm arched multi-function shower • Soft, pulsating and bubble spray functions • Rub-clean spray diffuser • Available in 3 Star 9L/min as per WELS licence number 0046 	







Model shown: CR 900T C



HANDHELD SHOWERS - CRYSTAL RAIL



- 700mm x 30mm brass curved slide rail
- Brass wall mount brackets
- Solid brass Friction Slide Cradle
- DR brass wall outlet elbow
- DR brass 9L/min flow Interchange® spigot
- Licenced dual check/non-return valve
- 57mm solid brass round flat flange
- 1500mm PVC hose



Model Code Finish Features



STREAMJET™			
	HS 010J C	Chrome	<ul style="list-style-type: none"> • ABS 100mm single function shower • Concentric full pattern spray • Rub-clean spray diffuser • WaterMark AS 3662 WMKT 21147 • Available in 3 Star 9L/min and 4 Star 6.5L/min as per WELS licence number 0046 
	HS 010J C/6.5	Chrome	
	HS 010J WTC	White/Chrome	
	HS 010J WTC/6.5	White/Chrome	

STREAMJET™ TURBO PULSATOR				
	HS 010T C	Chrome	<ul style="list-style-type: none"> • ABS 100mm multi-function shower • Soft, pulsating and bubble spray functions • Rub-clean spray diffuser • WaterMark AS 3662 WMKT 21147 • Available in 3 Star 9L/min as per WELS licence number 0046 	

STREAMJET™ XL				
	HS 010X C	Chrome	<ul style="list-style-type: none"> • ABS 130mm single function shower • Concentric full pattern spray • Rub-clean spray diffuser • WaterMark AS 3662 WMKT 21147 • Available in 3 Star 9L/min as per WELS licence number 0046 	

STREAMJET™ XL TURBO PULSATOR				
	HS 010S C	Chrome	<ul style="list-style-type: none"> • ABS 130mm multi-function shower • Soft, pulsating and bubble spray functions • Rub-clean spray diffuser • WaterMark AS 3662 WMKT 21147 • Available in 3 Star 9L/min as per WELS licence number 0046 	

PRINCESS				
	HS 010P C	Chrome	<ul style="list-style-type: none"> • ABS 83mm arched single function shower • Full pattern spray • Rub-clean spray diffuser • WaterMark AS 3662 WMKT 21147 • Available in 3 Star 9L/min as per WELS licence number 0046 	

BREEZE				
	HS 010Z C	Chrome	<ul style="list-style-type: none"> • ABS 104mm arched multi-function shower • Soft, pulsating and bubble spray functions • Rub-clean spray diffuser • Available in 3 Star 9L/min as per WELS licence number 0046 	

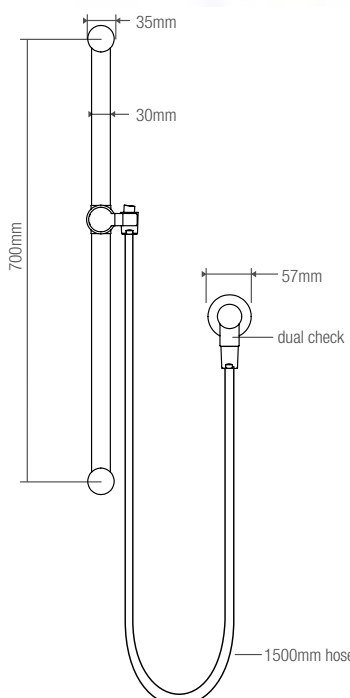





Model shown: HS 010X C

HANDHELD SHOWERS - WALL OUTLET BRACKET



- 85mm DR brass right angled wall outlet bracket
- DR brass 9L/min flow Interchange® spigot
- Licenced dual check/non-return valve
- 57mm solid brass round flat flange
- 1500mm PVC hose



Model Code Finish Features



STREAMJET™			
	HS 011J BN	Brushed Nickel	<ul style="list-style-type: none"> • ABS 100mm single function shower • Concentric full pattern spray • Rub-clean spray diffuser • WaterMark AS 3662 WMKT 21147 • Available in 3 Star 9L/min and 4 Star 6.5L/min as per WELS licence number 0046 
	HS 011J BN/6.5	Brushed Nickel	
	HS 011J C	Chrome	
	HS 011J C/6.5	Chrome	
	HS 011J MB	Matte Black	
	HS 011J MB/6.5	Matte Black	
	HS 011J WTC	White/Chrome	
	HS 011J WTC/6.5	White/Chrome	

STREAMJET™ TURBO PULSATOR				
	HS 011T C	Chrome	<ul style="list-style-type: none"> • ABS 100mm multi-function shower • Soft, pulsating and bubble spray functions • Rub-clean spray diffuser • WaterMark AS 3662 WMKT 21147 • Available in 3 Star 9L/min as per WELS licence number 0046 	

STREAMJET™ XL				
	HS 011X BN	Brushed Nickel*	<ul style="list-style-type: none"> • ABS 130mm single function shower • Concentric full pattern spray • Rub-clean spray diffuser • WaterMark AS 3662 WMKT 21147 • Available in 3 Star 9L/min as per WELS licence number 0046 	
	HS 011X C	Chrome		
	HS 011X MB	Matte Black*		
		*AVAILABLE JULY 2022		

STREAMJET™ XL TURBO PULSATOR				
	HS 011S C	Chrome	<ul style="list-style-type: none"> • ABS 130mm multi-function shower • Soft, pulsating and bubble spray functions • Rub-clean spray diffuser • WaterMark AS 3662 WMKT 21147 • Available in 3 Star 9L/min as per WELS licence number 0046 	

PRINCESS				
	HS 011P C	Chrome	<ul style="list-style-type: none"> • ABS 83mm arched single function shower • Full pattern spray • Rub-clean spray diffuser • WaterMark AS 3662 WMKT 21147 • Available in 3 Star 9L/min as per WELS licence number 0046 	

BREEZE				
	HS 011Z C	Chrome	<ul style="list-style-type: none"> • ABS 104mm arched multi-function shower • Soft, pulsating and bubble spray functions • Rub-clean spray diffuser • Available in 3 Star 9L/min as per WELS licence number 0046 	

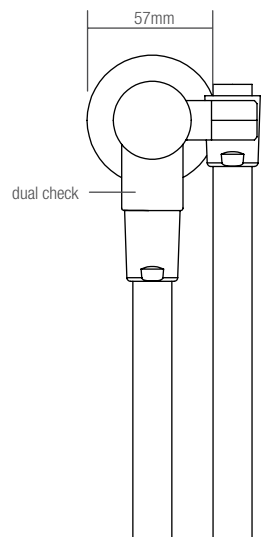

Model shown: HS 011T C

HANDHELD SHOWERS WALL OUTLET BRACKET



WaterMark
AS/NZS 3662
WMKT 21147

HANDHELD SHOWERS - FOR RAILS ONLY













- DR brass wall outlet bracket
- DR brass 9L/min flow Interchange® spigot
- Licenced dual check/non-return valve
- 57mm solid brass round flat flange
- 1500mm PVC hose



HANDPIECE SUPPORT NOT INCLUDED











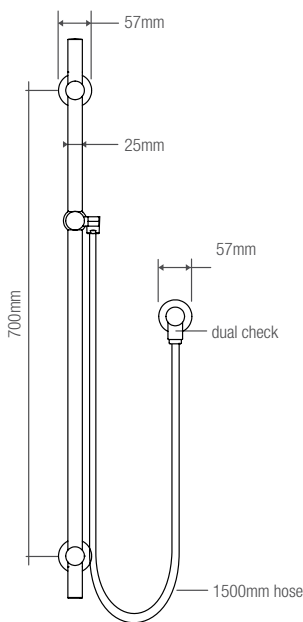





Model shown: HS 017J C

Model	Code	Finish	Features	
STREAMJET™				
	HS 017J BN	Brushed Nickel	<ul style="list-style-type: none"> • ABS 100mm single function shower • Concentric full pattern spray • Rub-clean spray diffuser • WaterMark AS 3662 WMKT 21147 • Available in 3 Star 9L/min and 4 Star 6.5L/min as per WELS licence number 0046 	
	HS 017J BN/6.5	Brushed Nickel		
	HS 017J C	Chrome		
	HS 017J C/6.5	Chrome		
	HS 017J MB	Matte Black		
	HS 017J MB/6.5	Matte Black		
	HS 017J WTC	White/Chrome		
HS 017J WTC/6.5	White/Chrome			
STREAMJET™ TURBO PULSATOR				
	HS 017T C	Chrome	<ul style="list-style-type: none"> • ABS 100mm multi-function shower • Soft, pulsating and bubble spray functions • Rub-clean spray diffuser • WaterMark AS 3662 WMKT 21147 • Available in 3 Star 9L/min as per WELS licence number 0046 	
STREAMJET™ XL				
	HS 017X BN	Brushed Nickel*	<ul style="list-style-type: none"> • ABS 130mm single function shower • Concentric full pattern spray • Rub-clean spray diffuser • WaterMark AS 3662 WMKT 21147 • Available in 3 Star 9L/min as per WELS licence number 0046 	
	HS 017X C	Chrome		
	HS 017X MB	Matte Black*		
		*AVAILABLE JULY 2022		
STREAMJET™ XL TURBO PULSATOR				
	HS 017S C	Chrome	<ul style="list-style-type: none"> • ABS 130mm multi-function shower • Soft, pulsating and bubble spray functions • Rub-clean spray diffuser • WaterMark AS 3662 WMKT 21147 • Available in 3 Star 9L/min as per WELS licence number 0046 	
PRINCESS				
	HS 017P C	Chrome	<ul style="list-style-type: none"> • ABS 83mm arched single function shower • Full pattern spray • Rub-clean spray diffuser • WaterMark AS 3662 WMKT 21147 • Available in 3 Star 9L/min as per WELS licence number 0046 	
HOSCARE®				
	HS 017H AC	Antimicrobial Chrome	<ul style="list-style-type: none"> • ABS 100mm single function shower with Biomaster antimicrobial additive • Concentric full pattern spray • Rub-clean spray diffuser • WaterMark AS 3662 WMKT 21147 • Available in 3 Star 9L/min as per WELS licence number 0046 	
	HS 017H AW	Antimicrobial White		

HANDHELD SHOWERS - POLAR RAIL

- 700mm x 25mm brass round slide rail
- Solid brass Friction Slide Cradle
- Floating brass wall mount brackets
- DR brass wall outlet elbow
- DR brass 9L/min flow Interchange® spigot
- Licenced dual check/non-return valve
- 57mm solid brass round flat flange
- 1500mm PVC hose



Model	Code	Finish	Features	
STREAMJET™				
	HS 020J BN	Brushed Nickel	<ul style="list-style-type: none"> • ABS 100mm single function shower • Concentric full pattern spray • Rub-clean spray diffuser • WaterMark AS 3662 WMKT 21147 • Available in 3 Star 9L/min and 4 Star 6.5L/min as per WELS licence number 0046 	
	HS 020J BN/6.5	Brushed Nickel		
	HS 020J C	Chrome		
	HS 020J C/6.5	Chrome		
	HS 020J MB	Matte Black		
	HS 020J MB/6.5	Matte Black		
STREAMJET™ TURBO PULSATOR				
	HS 020T C	Chrome	<ul style="list-style-type: none"> • ABS 100mm multi-function shower • Soft, pulsating and bubble spray functions • Rub-clean spray diffuser • WaterMark AS 3662 WMKT 21147 • Available in 3 Star 9L/min as per WELS licence number 0046 	
STREAMJET™ XL				
	HS 020X BN	Brushed Nickel*	<ul style="list-style-type: none"> • ABS 130mm single function shower • Concentric full pattern spray • Rub-clean spray diffuser • WaterMark AS 3662 WMKT 21147 • Available in 3 Star 9L/min as per WELS licence number 0046 	
	HS 020X C	Chrome		
	HS 020X MB	Matte Black*		
		*AVAILABLE JULY 2022		
STREAMJET™ XL TURBO PULSATOR				
	HS 020S C	Chrome	<ul style="list-style-type: none"> • ABS 130mm multi-function shower • Soft, pulsating and bubble spray functions • Rub-clean spray diffuser • WaterMark AS 3662 WMKT 21147 • Available in 3 Star 9L/min as per WELS licence number 0046 	
PRINCESS				
	HS 020P C	Chrome	<ul style="list-style-type: none"> • ABS 83mm arched single function shower • Full pattern spray • Rub-clean spray diffuser • WaterMark AS 3662 WMKT 21147 • Available in 3 Star 9L/min as per WELS licence number 0046 	
BREEZE				
	HS 020Z C	Chrome	<ul style="list-style-type: none"> • ABS 104mm arched multi-function shower • Soft, pulsating and bubble spray functions • Rub-clean spray diffuser • Available in 3 Star 9L/min as per WELS licence number 0046 	



Model shown: HS 020P C

HANDHELD SHOWERS - RIVIERA RAIL

- 800mm x 25mm brass round slide rail
- Solid brass Friction Slide Cradle
- DR brass floating lower mount bracket
- Top mount 9L/min Interchange® spigot
- DR brass flow outlet hose connection
- Licenced dual check/non-return valve
- 57mm solid brass round flat flange
- 1500mm PVC hose

Model Code Finish Features

STREAMJET™



TOP INLET

HS 026J BN	Brushed Nickel
HS 026J BN/6.5	Brushed Nickel
HS 026J C	Chrome
HS 026J C/6.5	Chrome
HS 026J MB	Matte Black
HS 026J MB/6.5	Matte Black

BOTTOM INLET

HS 036J BN	Brushed Nickel
HS 036J BN/6.5	Brushed Nickel
HS 036J C	Chrome
HS 036J C/6.5	Chrome
HS 036J MB	Matte Black
HS 036J MB/6.5	Matte Black

- ABS 100mm single function shower
- Concentric full pattern spray
- Rub-clean spray diffuser
- WaterMark AS 3662 WMKT 21147
- Available in 3 Star 9L/min and 4 Star 6.5L/min as per WELS licence number 0046



STREAMJET™ TURBO PULSATOR



TOP INLET

HS 026T C	Chrome
-----------	--------

BOTTOM INLET

HS 036T C	Chrome
-----------	--------

- ABS 100mm multi-function shower
- Soft, pulsating & bubble spray
- WaterMark AS 3662 WMKT 21147
- Available in 3 Star 9L/min as per WELS licence number 0046



STREAMJET™ XL



TOP INLET

HS 026X BN	Brushed Nickel*
HS 026X C	Chrome
HS 026X MB	Matte Black*

BOTTOM INLET

HS 036X BN	Brushed Nickel*
HS 036X C	Chrome
HS 036X MB	Matte Black*

- ABS 130mm single function shower
- Concentric full pattern spray
- Rub-clean spray diffuser
- WaterMark AS 3662 WMKT 21147
- Available in 3 Star 9L/min as per WELS licence number 0046



*AVAILABLE JULY 2022

STREAMJET™ XL TURBO PULSATOR



TOP INLET

HS 026S C	Chrome
-----------	--------

BOTTOM INLET

HS 036S C	Chrome
-----------	--------

- ABS 130mm multi-function shower
- Soft, pulsating and bubble spray
- WaterMark AS 3662 WMKT 21147
- Available in 3 Star 9L/min as per WELS licence number 0046



PRINCESS



TOP INLET

HS 026P C	Chrome
-----------	--------

BOTTOM INLET

HS 036P C	Chrome
-----------	--------

- ABS 83mm arched shower
- Single function, full pattern spray
- WaterMark AS 3662 WMKT 21147
- Available in 3 Star 9L/min as per WELS licence number 0046



BREEZE



TOP INLET

HS 026Z C	Chrome
-----------	--------

BOTTOM INLET

HS 036Z C	Chrome
-----------	--------

- ABS 104mm arched shower
- Multi-function soft, pulsating and bubble spray
- Available in 3 Star 9L/min as per WELS licence number 0046

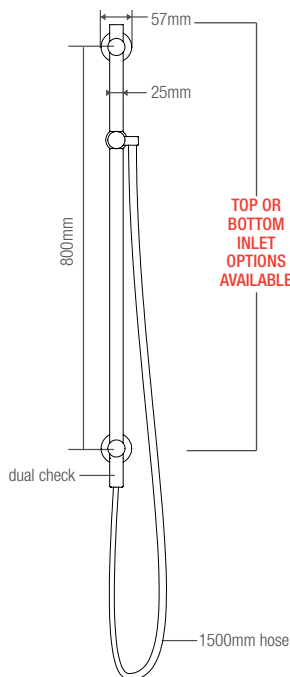







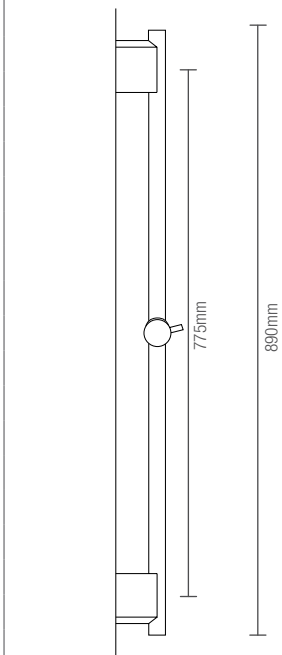



Model shown: HS 026Z C

HANDHELD SHOWERS - ANTONIO RAIL

- 700mm x 22mm tubular rail
- ABS adjustable slide cradle
- DR brass wall outlet elbow
- DR brass 9L/min flow Interchange® spigot
- Licenced dual check/non-return valve
- 57mm solid brass round flat flange
- 1500mm PVC hose





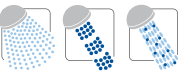

Model shown: HS 030J C

Model	Code	Finish	Features
STREAMJET™			
	HS 030J C	Chrome	<ul style="list-style-type: none"> • ABS 100mm single function shower • Concentric full pattern spray • Rub-clean spray diffuser • WaterMark AS 3662 WMKT 21147 • Available in 3 Star 9L/min and 4 Star 6.5L/min as per WELS licence number 0046 
	HS 030J C/6.5	Chrome	
STREAMJET™ TURBO PULSATOR			
	HS 030T C	Chrome	<ul style="list-style-type: none"> • ABS 100mm multi-function shower • Soft, pulsating and bubble spray functions • Rub-clean spray diffuser • WaterMark AS 3662 WMKT 21147 • Available in 3 Star 9L/min as per WELS licence number 0046 
STREAMJET™ XL			
	HS 030X C	Chrome	<ul style="list-style-type: none"> • ABS 130mm single function shower • Concentric full pattern spray • Rub-clean spray diffuser • WaterMark AS 3662 WMKT 21147 • Available in 3 Star 9L/min as per WELS licence number 0046 
STREAMJET™ XL TURBO PULSATOR			
	HS 030S C	Chrome	<ul style="list-style-type: none"> • ABS 130mm multi-function shower • Soft, pulsating and bubble spray functions • Rub-clean spray diffuser • WaterMark AS 3662 WMKT 21147 • Available in 3 Star 9L/min as per WELS licence number 0046 
PRINCESS			
	HS 030P C	Chrome	<ul style="list-style-type: none"> • ABS 83mm arched single function shower • Full pattern spray • Rub-clean spray diffuser • WaterMark AS 3662 WMKT 21147 • Available in 3 Star 9L/min as per WELS licence number 0046 
BREEZE			
	HS 030Z C	Chrome	<ul style="list-style-type: none"> • ABS 104mm arched multi-function shower • Soft, pulsating and bubble spray functions • Rub-clean spray diffuser • Available in 3 Star 9L/min as per WELS licence number 0046 

HANDHELD AND COMBINATION SHOWERS

QUEWB

Contemporary square design combining minimalist beauty and bold square edge profiles. The Quewb offers a full body spray with rub-clean features. All Con-Serv Quewb showers are 3 Star 9L/min as per WELS licence number 0046.

	Code	Finish	Features	
QUEWB SLIDE RAIL				
	HS 010U C	Chrome	<ul style="list-style-type: none"> • Brass 700mm square edge slide track • Brass square edge friction slide cradle • ABS square single function shower rose with rub-clean spray diffuser • PVC 1500mm Silverflex™ hose with ½" BSP swivel conical end nut • DR brass square edge wall outlet elbow with flow Interchange® spigot • Licenced dual check/non-return valve • Brass 57mm square wall flange • WaterMark AS/NZS 3662 WMKT 21147 • Licenced dual check/non-return as per WaterMark AS/NZS 2845.1 WMKA 02696 • 3 Star 9L/min as per WELS licence number 0046 	
QUEWB TWIN WATERS™				
	TOP INLET		<ul style="list-style-type: none"> • ABS 220mm rainmaker overhead shower rose with rub-clean spray diffuser • ABS square single function handheld shower with rub-clean spray diffuser • Brass 800mm rail and brackets with adjustable lower bracket • Brass 380mm swivel crane arm • Brass 19mm female inlet diverter switchcock valve with flow Interchange® spigot • Brass friction slide cradle for handset support and height adjustment • PVC 1500mm Silverflex™ hose with ½" BSP swivel conical end nut • Brass 57mm square wall flanges • Stainless steel fixings supplied • Full pattern spray • WaterMark AS/NZS 3662 WMKT 21147 • 3 Star 9L/min as per WELS licence number 0046 	
	TW 029QU C	Chrome		
	BOTTOM INLET			
	TW 039QU C	Chrome		



TWIN WATERS™ - COSMIC SWAN NECK

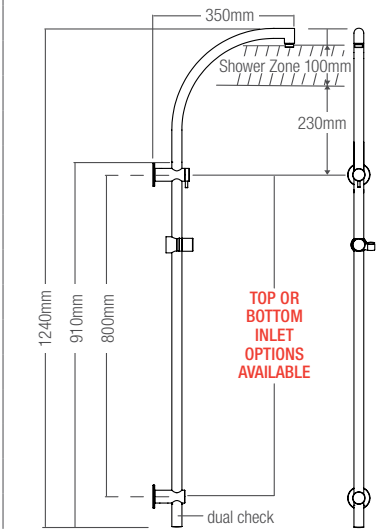

- Cosmic ABS 256mm rainmaker shower rose
- 800mm x 25mm rail with adjustable brackets
- Swan neck swivelling shower arm
- Brass friction slide cradle
- Diverter switchcock valve
- Licenced dual check/non-return valve
- 57mm solid brass round flat flange
- 1500mm PVC hose



Model Code Finish Features







Model shown: TW 025CJ C



STREAMJET™			
	TOP INLET		<ul style="list-style-type: none"> • ABS 100mm single function shower • Concentric full pattern spray • Rub-clean spray diffuser • WaterMark AS 3662 WMKT 21147 • Available in 3 Star 9L/min as per WELS licence number 0046 
	TW 025CJ BN	Brushed Nickel	
	TW 025CJ C	Chrome	
	TW 025CJ MB	Matte Black	
	BOTTOM INLET		
	TW 035CJ BN	Brushed Nickel	
TW 035CJ C	Chrome		
TW 035CJ MB	Matte Black		

STREAMJET™ TURBO PULSATOR			
	TOP INLET		<ul style="list-style-type: none"> • ABS 100mm multi-function shower • Soft, pulsating and bubble spray functions • Rub-clean spray diffuser • WaterMark AS 3662 WMKT 21147 • Available in 3 Star 9L/min as per WELS licence number 0046 
	TW 025CT C	Chrome	
	BOTTOM INLET		
	TW 035CT C	Chrome	

STREAMJET™ XL			
	TOP INLET		<ul style="list-style-type: none"> • ABS 130mm single function shower • Concentric full pattern spray • Rub-clean spray diffuser • WaterMark AS 3662 WMKT 21147 • Available in 3 Star 9L/min as per WELS licence number 0046  <p><i>*AVAILABLE JULY 2022</i></p>
	TW 025CX BN	Brushed Nickel*	
	TW 025CX C	Chrome	
	TW 025CX MB	Matte Black*	
	BOTTOM INLET		
	TW 035CX BN	Brushed Nickel*	
TW 035CX C	Chrome		
TW 035CX MB	Matte Black*		

STREAMJET™ XL TURBO PULSATOR			
	TOP INLET		<ul style="list-style-type: none"> • ABS 130mm multi-function shower • Soft, pulsating and bubble spray functions • Rub-clean spray diffuser • WaterMark AS 3662 WMKT 21147 • Available in 3 Star 9L/min as per WELS licence number 0046 
	TW 025CS C	Chrome	
	BOTTOM INLET		
	TW 035CS C	Chrome	



PRINCESS			
	TOP INLET		<ul style="list-style-type: none"> • ABS 83mm arched single function shower • Full pattern spray • Rub-clean spray diffuser • WaterMark AS 3662 WMKT 21147 • Available in 3 Star 9L/min as per WELS licence number 0046 
	TW 025CP C	Chrome	
	BOTTOM INLET		
	TW 035CP C	Chrome	

BREEZE			
	TOP INLET		<ul style="list-style-type: none"> • ABS 104mm arched multi-function shower • Soft, pulsating and bubble spray functions • Rub-clean spray diffuser • Available in 3 Star 9L/min as per WELS licence number 0046 
	TW 025CZ C	Chrome	
	BOTTOM INLET		
	TW 035CZ C	Chrome	



TWIN WATERS™ - COSMIC CRANE ARM



- Cosmic ABS 256mm rainmaker shower rose
- 800mm x 25mm rail with adjustable brackets
- Crane neck swivelling shower arm
- Brass friction slide cradle
- Diverter switchcock valve
- Licenced dual check/non-return valve
- 57mm solid brass round flat flange
- 1500mm PVC hose

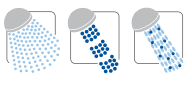

Model Code Finish Features



STREAMJET™			
	TOP INLET		<ul style="list-style-type: none"> • ABS 100mm single function shower • Concentric full pattern spray • Rub-clean spray diffuser • WaterMark AS 3662 WMKT 21147 • Available in 3 Star 9L/min as per WELS licence number 0046 
	TW 029CJ BN	Brushed Nickel	
	TW 029CJ C	Chrome	
	TW 029CJ MB	Matte Black	
	BOTTOM INLET		
	TW 039CJ BN	Brushed Nickel	
TW 039CJ C	Chrome		
TW 039CJ MB	Matte Black		

STREAMJET™ TURBO PULSATOR			
	TOP INLET		<ul style="list-style-type: none"> • ABS 100mm multi-function shower • Soft, pulsating and bubble spray functions • Rub-clean spray diffuser • WaterMark AS 3662 WMKT 21147 • Available in 3 Star 9L/min as per WELS licence number 0046 
	TW 029CT C	Chrome	
	BOTTOM INLET		
	TW 039CT C	Chrome	

STREAMJET™ XL			
	TOP INLET		<ul style="list-style-type: none"> • ABS 130mm single function shower • Concentric full pattern spray • Rub-clean spray diffuser • WaterMark AS 3662 WMKT 21147 • Available in 3 Star 9L/min as per WELS licence number 0046  <p><i>*AVAILABLE JULY 2022</i></p>
	TW 029CX BN	Brushed Nickel*	
	TW 029CX C	Chrome	
	TW 029CX MB	Matte Black*	
	BOTTOM INLET		
	TW 039CX BN	Brushed Nickel*	
TW 039CX C	Chrome		
TW 039CX MB	Matte Black*		

STREAMJET™ XL TURBO PULSATOR			
	TOP INLET		<ul style="list-style-type: none"> • ABS 130mm multi-function shower • Soft, pulsating and bubble spray functions • Rub-clean spray diffuser • WaterMark AS 3662 WMKT 21147 • Available in 3 Star 9L/min as per WELS licence number 0046 
	TW 029CS C	Chrome	
	BOTTOM INLET		
	TW 039CS C	Chrome	

PRINCESS			
	TOP INLET		<ul style="list-style-type: none"> • ABS 83mm arched single function shower • Full pattern spray • Rub-clean spray diffuser • WaterMark AS 3662 WMKT 21147 • Available in 3 Star 9L/min as per WELS licence number 0046 
	TW 029CP C	Chrome	
	BOTTOM INLET		
	TW 039CP C	Chrome	

BREEZE			
	TOP INLET		<ul style="list-style-type: none"> • ABS 104mm arched multi-function shower • Soft, pulsating and bubble spray functions • Rub-clean spray diffuser • Available in 3 Star 9L/min as per WELS licence number 0046 
	TW 029CZ C	Chrome	
	BOTTOM INLET		
	TW 039CZ C	Chrome	

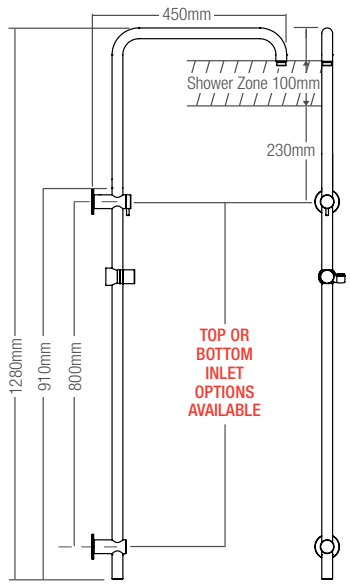









Model shown: TW 029CT C

SPARE PARTS ELBOWS AND BRACKETS

Con-Serv wall elbow and brackets include non-return valves as per WaterMark Licence 02696. This removes the possibility of a handheld shower being the source of backflow contamination to the water supply should it be immersed in the bath or other vessel.



	Code	Finish	Features	
ANTI-LIGATURE WALL OUTLET ELBOW WITH DUAL CHECK VALVE				
	EB 044 C	Chrome	<ul style="list-style-type: none"> • 50mm anti-ligature wall outlet elbow • Force release mechanism releases hose from wall outlet elbow when 10kg of weight is applied. • Brass construction • ½" BSP female inlet with ½" BSP male threaded outlet • Licenced dual check/non-return as per WaterMark AS/NZS 2845.1 WMKA 02696 (dual check valve only) 	
WALL OUTLET ELBOW WITH DUAL CHECK VALVE				
	EB 045 C	Chrome	<ul style="list-style-type: none"> • 50mm wall outlet elbow • Brass construction • ½" BSP female inlet with ½" BSP male threaded outlet • Licenced dual check/non-return as per WaterMark AS/NZS 2845.1 WMKA 02696 (dual check valve only) 	
WALL OUTLET ELBOW WITH DUAL CHECK VALVE				
	EB 046 AWC	Antimicrobial White/Chrome	<ul style="list-style-type: none"> • 55mm wall outlet elbow • Brass 57mm wall flange • Flow Interchange® spigot • ½" BSP female inlet with ½" BSP male threaded outlet • Licenced dual check/non-return as per WaterMark AS/NZS 2845.1 WMKA 02696 (dual check valve only) 	
	EB 046 BN	Brushed Nickel		
	EB 046 C	Chrome		
	EB 046 MB	Matte Black		
WALL OUTLET ELBOW BRACKET WITH DUAL CHECK VALVE				
	EB 073 AWC	Antimicrobial White/Chrome	<ul style="list-style-type: none"> • 85mm right-angled wall outlet handset bracket • Brass 57mm wall flange • Flow Interchange® spigot • ½" BSP female inlet with ½" BSP male threaded outlet • Licenced dual check/non-return as per WaterMark AS/NZS 2845.1 WMKA 02696 (dual check valve only) 	
	EB 073 BN	Brushed Nickel		
	EB 073 C	Chrome		
	EB 073 MB	Matte Black		
WALL MOUNT HANDSET BRACKET				
	EB 074 C	Chrome	<ul style="list-style-type: none"> • 85mm right-angled wall mount handset bracket • Dual screw wall mount • Brass construction • Brass 57mm wall flange 	
	EB 074 MB	Matte Black		
SQUARE-EDGE WALL OUTLET ELBOW WITH DUAL CHECK VALVE				
	EB 075 C	Chrome	<ul style="list-style-type: none"> • 55mm Square-edge wall outlet elbow • Brass construction • Brass 57mm wall flange • Flow Interchange® spigot • Licenced dual check/non-return as per WaterMark AS/NZS 2845.1 WMKA 02696 (dual check valve only) 	
ON/OFF BUTTON CONTROL VALVE				
	DV 044 C	Chrome	<ul style="list-style-type: none"> • On/off shower valve • Brass construction • Not to be used as a line end stop control 	
WALL MOUNT ABS HANDSET BRACKET				
	EB 085 C	Chrome	<ul style="list-style-type: none"> • 70mm ABS wall mount handset bracket • Fixed position, not adjustable • Dual screw fixing • Stainless steel fixings supplied 	

SPARE PARTS RAILS AND FLANGES

The Friction Slide Handset Support Cradle on these rails is designed for persons with weakened wrist, arthritic or grip problems. When installed in a moist environment (such as a bathroom) the slider will adjust easily. It may grip to the rail in a dry environment (such as a display room).

	Code	Finish	Features
SLIDE RAILS			
	CRYSTAL SLIDE RAIL (A)		
	SR 010 AWC	Antimicrobial White/Chrome	<ul style="list-style-type: none"> • Brass 700mm low profile track • Brass friction slide cradle, track supports and end caps
	SR 010 C	Chrome	
	POLAR SLIDE RAIL (B)		
	SR 020 AWC	Antimicrobial White/Chrome	<ul style="list-style-type: none"> • Brass 700mm, centre to centre rail • Brass friction slide cradle for handset support and height adjustment • Brass wall brackets and 57mm wall flanges
	SR 020 BN	Brushed Nickel	
	SR 020 C	Chrome	
	SR 020 MB	Matte Black	
	QUEWB SLIDE RAIL (C)		
	SR 028 C	Chrome	<ul style="list-style-type: none"> • Brass 700mm low profile track • Square edge design • Brass friction slide cradle for handset adjustment
	RIVIERA SLIDE RAIL (D)		
	SR 026 BN	Brushed Nickel	<ul style="list-style-type: none"> • Brass 800mm rail with adjustable lower bracket • Concealed top inlet; Flow Interchange® spigot • Brass friction slide cradle and 57mm wall flanges • PVC 1500mm hose with ½" BSP swivel conical end nut
	SR 026 C	Chrome	
	SR 026 MB	Matte Black	
TWIN WATERS™ SLIDE RAILS AND EXTENSIONS			
	CRANE NECK TWIN WATERS™ SLIDE RAIL (A)		
	SR 029 BN	Brushed Nickel	<ul style="list-style-type: none"> • Brass 800mm rail with 380mm swivel arm • Brass friction slide cradle and 19mm female inlet diverter switchcock valve with flow Interchange® spigot • PVC 1500mm Silverflex™ hose
	SR 029 C	Chrome	
	SR 029 MB	Matte Black	
	SWAN NECK TWIN WATERS™ SLIDE RAIL (B)		
	SR 025 BN	Brushed Nickel	<ul style="list-style-type: none"> • Brass 800mm rail with 345mm swivel arm • Brass friction slide cradle and 19mm female inlet diverter switchcock valve with flow Interchange® spigot • PVC 1500mm Silverflex™ hose
	SR 025 C	Chrome	
	SR 025 MB	Matte Black	
	TWIN WATERS™ RAIL TUBE (NOT PICTURED)		
	SR 400 C RA	Chrome	<ul style="list-style-type: none"> • Brass 400mm reduced length 25mm rail tube for Twin Waters™ showers
	TWIN WATERS™ 140MM CRANE ARM TUBE ONLY (C)		
	SP 140 C TO	Chrome	<ul style="list-style-type: none"> • Low rise option for Twin Waters™ overhead arm • Brass construction
	SP 140 MB TO	Matte Black	
TWIN WATERS™ OVERHEAD EXTENSIONS (NOT PICTURED)			
SR 025 C OS	Chrome 100mm	<ul style="list-style-type: none"> • Brass 25mm extended overhead connector for Twin Waters™ • Available in 100mm, 200mm and 300mm extensions 	
SR 025 C OM	Chrome 200mm		
SR 025 C OL	Chrome 300mm		
DOMED WALL FLANGE - ROUND			
	WF 057 AW DO	Antimicrobial White	<ul style="list-style-type: none"> • Brass 57mm domed wall flange • 8mm dome height (total)
	WF 057 C DO	Chrome	
FLAT WALL FLANGE - ROUND			
	WF 057 AW FL	Antimicrobial White	<ul style="list-style-type: none"> • Brass 57mm wall flange
	WF 057 BN FL	Brushed Nickel	
	WF 057 C FL	Chrome	
	WF 057 MB FL	Matte Black	
FLAT WALL FLANGE - SQUARE			
	WF 057 C QU	Chrome	<ul style="list-style-type: none"> • Brass 57mm wall flange

SPARE PARTS SHOWER ARMS







All Con-Serv shower arm attachments are sold NON Water Saving (NWS).
Con-Serv's Water Efficiency Licence number 0046 only covers testing on shower arm and shower rose combinations.

	Code	Finish	Features
CLICKLOCK™ ORBITAL/ADJUSTABLE ARM			
 <p>Accepts 130mm maximum ABS rose size only</p>	SA 060 AWC	Antimicrobial White/Chrome	<ul style="list-style-type: none"> Clicklock™ 300mm adjustable height shower arm Orbital swivelling end Brass construction Brass 57mm wall flange Full flow Interchange® spigot ½" BSP female inlet with ½" BSP male threaded outlet
	SA 060 BN	Brushed Nickel	
	SA 060 C	Chrome	
	SA 060 MB	Matte Black	
GRAND ARM			
	SA 165 AW	Antimicrobial White	<ul style="list-style-type: none"> 165mm upswept fixed shower arm Brass construction ½" BSP female inlet with ½" BSP male threaded outlet
	SA 165 C	Chrome	
HORIZONTAL ARM 310MM			
	SA 310 C	Chrome	<ul style="list-style-type: none"> 310mm horizontal shower arm Brass construction Brass 57mm wall flange Full flow Interchange® spigot ½" BSP female inlet with ½" BSP male threaded outlet
	SA 310 MB	Matte Black	
HORIZONTAL ARM 450MM			
	SA 450 BN HZ	Brushed Nickel	<ul style="list-style-type: none"> 450mm extended projection horizontal arm 316 stainless steel construction for added strength 316 stainless steel 62mm wall flange Full flow Interchange® spigot ½" BSP female inlet with ½" BSP male threaded outlet
	SA 450 C HZ	Chrome	
	SA 450 MB HZ	Matte Black	
LIMITED PROJECTION ARM			
	SA 005 C	Chrome	<ul style="list-style-type: none"> 55mm x 20° fixed shower arm Brass construction Brass 57mm wall flange Full flow Interchange® spigot ½" BSP female inlet with ½" BSP male threaded outlets
SWAN NECK RISING ARM			
	SA 090 AWC	Antimicrobial White/Chrome	<ul style="list-style-type: none"> 290mm swan neck shower arm Most suitable for gravity fed shower applications Brass construction Brass 57mm wall flange Full flow Interchange® spigot ½" BSP female inlet with ½" BSP male threaded outlet
	SA 090 BN	Brushed Nickel	
	SA 090 C	Chrome	
	SA 090 MB	Matte Black	
SWIVEL CRANE NECK ARM			
 <p>A. 423mm, 392mm</p> <p>B. 423mm, 160mm</p>	380MM ARM (A)		<ul style="list-style-type: none"> Swivel crane neck shower arm Brass construction Brass 57mm wall flange Full flow Interchange® spigot ½" BSP female inlet with ½" BSP male threaded outlet
	SA 380 BN	Brushed Nickel	
	SA 380 C	Chrome	
	SA 380 MB	Matte Black	
	140MM ARM (B)		
	SA 140 C	Chrome	
	SA 140 MB	Matte Black	
	140MM CRANE ARM TUBE ONLY (NOT PICTURED)		
	SP 140 C TO	Chrome	
	SP 140 MB TO	Matte Black	
SWIVEL SWAN NECK ARM			
	SA 345 C	Chrome	<ul style="list-style-type: none"> 345mm swan neck swivelling shower arm Brass construction Brass 57mm wall flange Full flow Interchange® spigot ½" BSP female inlet with ½" BSP male threaded outlet
	SA 345 MB	Matte Black	

SPARE PARTS

SHOWER ARMS, SLIDERS AND ACCESSORIES

All Con-Serv shower arm attachments are sold NON Water Saving (NWS).
Con-Serv's Water Efficiency Licence number 0046 only covers testing on shower arm and shower rose combinations.

	Code	Finish	Features
UPSWEPT FIXED ARM			
	SA 030 AW	Antimicrobial White	<ul style="list-style-type: none"> • 150mm upswept fixed shower arm • Brass construction • Brass 57mm wall flange • Full flow Interchange® spigot • ½" BSP female inlet with ½" BSP male threaded outlet
	SA 030 BN	Brushed Nickel	
	SA 030 C	Chrome	
	SA 030 MB	Matte Black	
UPSWEPT ADJUSTABLE ARM			
	SA 070 AWC	Antimicrobial White/ Chrome	<ul style="list-style-type: none"> • 260mm upswept adjustable height shower arm • Brass construction • 57mm domed wall flange • ½" BSP female inlet with ½" BSP male threaded outlet
	SA 070 C	Chrome	
	REPLACEMENT ADJUSTABLE ARM OLIVE		
	SP 063	2 pack	
VERTICAL ARM			
 <div style="position: absolute; top: 10px; left: 10px; border: 1px solid black; border-radius: 50%; padding: 2px;">NEW SIZES</div>	150MM VERTICAL ARM		<ul style="list-style-type: none"> • Vertical shower arm for ceiling installations • Available in lengths of 150mm, 300mm, 450mm and 600mm • Brass construction • Brass 62mm wall flange • Full flow Interchange® spigot • ½" BSP female inlet with ½" BSP male threaded outlet
	SA 150 BN	Brushed Nickel	
	SA 150 C	Chrome	
	SA 150 MB	Matte Black	
	300MM VERTICAL ARM		
	SA 300 BN	Brushed Nickel	
	SA 300 C	Chrome	
	SA 300 MB	Matte Black	
	450MM VERTICAL ARM		
	SA 450 BN	Brushed Nickel	
	SA 450 C	Chrome	
	SA 450 MB	Matte Black	
	600MM VERTICAL ARM		
	SA 600 BN	Brushed Nickel	
SA 600 C	Chrome		
SA 600 MB	Matte Black		
ABS SLIDE RAIL HANDPIECE GLIDE SLIDE CRADLE			
	HC 025 C	Chrome	<ul style="list-style-type: none"> • Fastens to 25mm slide rail • ABS construction • Push-button lock mechanism
	HC 025 WT	White	
BRASS FRICTION SLIDE HANDPIECE CRADLE			
	HC 020 AWC	Antimicrobial White/ Chrome	<ul style="list-style-type: none"> • Suitable for Con-Serv 25mm Polar slide rail • Brass construction
	HC 020 BN	Brushed Nickel	
	HC 020 C	Chrome	
	HC 020 MB	Matte Black	
CRYSTAL FRICTION SLIDE HANDPIECE CRADLE			
	HC 010 AWC	Antimicrobial White/ Chrome	<ul style="list-style-type: none"> • Suitable for Con-Serv 25mm Crystal slide track only • Brass construction
	HC 010 C	Chrome	
RAIL SOAP DISH			
	SD 025 CL	Clear	<ul style="list-style-type: none"> • Fastens to 25mm tubular rails • ABS construction • 115mm x 175mm • Self-draining

SPARE PARTS SHOWER HANDPIECES

Handpieces must be installed with a Con-Serv water outlet component to achieve the licenced WELS rating. Handpieces that provide restriction at the showerhead, subject the hose to back pressure which shortens the life of the hose and could dislodge the handpieces.

	Code	Finish	Features
STREAMJET™			
	HP 038 BN	Brushed Nickel	<ul style="list-style-type: none"> • ABS 100mm single function shower • Concentric full pattern spray • Rub-clean spray diffuser • WaterMark AS 3662 WMKT 21147 • Available in 3 Star 9L/min and 4 Star 6.5L/min as per WELS licence number 0046 • To achieve the WELS 3 Star or 4 Star rating, this product must be installed with a Con-Serv wall outlet component 
	HP 038 C	Chrome	
	HP 038 MB	Matte Black	
	HP 038 WT	White	
STREAMJET™ TURBO PULSATOR			
	HP 042 C	Chrome	<ul style="list-style-type: none"> • ABS 100mm multi-function shower • Soft, pulsating and bubble spray functions • Rub-clean spray diffuser • WaterMark AS 3662 WMKT 21147 • 3 Star 9L/min as per WELS licence number 0046 • To achieve the WELS 3 Star rating, this product must be installed with a Con-Serv wall outlet component 
STREAMJET™ XL			
	HP 130 BN	Brushed Nickel*	<ul style="list-style-type: none"> • ABS 130mm extra-large single function shower • Concentric full pattern spray • Rub-clean spray diffuser • WaterMark AS 3662 WMKT 21147 • 3 Star 9L/min as per WELS licence number 0046 • To achieve the WELS 3 Star rating, this product must be installed with a Con-Serv wall outlet component 
	HP 130 C	Chrome	
	HP 130 MB	Matte Black*	
		*AVAILABLE JULY 2022	
STREAMJET™ XL TURBO			
	HP 142 C	Chrome	<ul style="list-style-type: none"> • ABS 130mm multi-function shower • Soft, pulsating, and bubble spray functions • Rub-clean spray diffuser • WaterMark AS 3662 WMKT 21147 • 3 Star 9L/min as per WELS licence number 0046 • To achieve the WELS 3 Star rating, this product must be installed with a Con-Serv wall outlet component 
QUEWB			
	HP 041 C	Chrome	<ul style="list-style-type: none"> • ABS 81mm square shaped shower • Low impact spray • Rub-clean spray diffuser • WaterMark AS/NZS 3662 WMKT 21147 • 3 Star 9L/min as per WELS licence number 0046 • To achieve the WELS 3 Star rating, this product must be installed with a Con-Serv wall outlet component 

SPARE PARTS SHOWER HANDPIECES

Handpieces must be installed with a Con-Serv water outlet component to achieve a 3 Star - 9L/min WELS rating. Handpieces that provide restriction at the showerhead, subject the hose to back pressure which shortens the life of the hose and could dislodge the handpieces.

	Code	Finish	Features	
BREEZE				
	HP 037 C	Chrome	<ul style="list-style-type: none"> • ABS 104mm arched multi-function shower • Soft, pulsating, and bubble spray functions • Rub-clean spray diffuser • WaterMark AS 3662 WMKT 21147 • 3 Star 9L/min as per WELS licence number 0046 • To achieve the WELS 3 Star rating, this product must be installed with a Con-Serv wall outlet component 	
HOSCARE®				
  	HP 030 AC	Antimicrobial Chrome	<ul style="list-style-type: none"> • ABS 100mm single function shower with Biomaster antimicrobial additive • Concentric full pattern spray • Rub-clean spray diffuser • WaterMark AS 3662 WMKT 21147 • Available in 3 Star 9L/min and 4 Star 6.5L/min as per WELS licence number 0046 • To achieve the WELS 3 Star or 4 Star rating, this product must be installed with a Con-Serv wall outlet component 	
	HP 030 AW	Antimicrobial White		
PRINCESS				
	HP 034 C	Chrome	<ul style="list-style-type: none"> • ABS 83mm arched multi-function shower • Full pattern spray • Rub-clean spray diffuser • WaterMark AS 3662 WMKT 21147 • 3 Star - 9 L/min as per WELS licence number 0046 • To achieve the WELS 3 Star rating, this product must be installed with a Con-Serv wall outlet component 	
HOSFAB®				
	HP 035 AW	Antimicrobial White	<ul style="list-style-type: none"> • ABS 69mm lightweight single function shower • Full pattern spray • Rub-clean spray diffuser • WaterMark AS 3662 WMKT 21147 • 3 Star 9L/min as per WELS licence number 0046 • To achieve the WELS 3 Star rating, this product must be installed with a Con-Serv wall outlet component 	
	HP 035 C	Chrome		
	HP 035 SW	Seasonal Inserts		
KLIPPER				
	HP 025 C	Chrome	<ul style="list-style-type: none"> • ABS 58mm side lever shower • On/off lock function • Firm pattern spray • WaterMark AS/NZS 3662 WMKT 21147 • 3 Star 9L/min as per WELS licence number 0046  <p>NOT TO BE USED AS LINE END STOP CONTROL. COULD CAUSE THERMAL SHOCK.</p>	

Con-Serv offer an extensive range of shower hoses in various finishes and standard lengths. PVC hoses can be made to any custom length P.O.A.











	Code	Length	Finish	Features
SILVERFLEX® SMOOTH SURFACE HOSE - PVC				
	SH 0900 CS	900mm	Chrome Silverflex®	<ul style="list-style-type: none"> • For use with handheld showers • Smooth PVC hose with elastic inner supported by polyester cords • 1 x ½" BSP swivel and 1 x ½" BSP fixed conical end nuts • Chrome finish
	SH 1200 CS	1200mm	Chrome Silverflex®	
	SH 1500 CS	1500mm	Chrome Silverflex®	
	SH 2000 CS	2000mm	Chrome Silverflex®	
MATTE BLACK SMOOTH SURFACE HOSE - PVC				
	SH 0900 MB	900mm	Matte Black	<ul style="list-style-type: none"> • For use with handheld showers • Smooth PVC hose with elastic inner supported by polyester cords • 1 x ½" BSP swivel and 1 x ½" BSP fixed conical end nuts • Matte black hose with matching components
	SH 1200 MB	1200mm	Matte Black	
	SH 1500 MB	1500mm	Matte Black	
	SH 2000 MB	2000mm	Matte Black	
BRUSHED NICKEL SMOOTH SURFACE HOSE - PVC				
	SH 0900 BN	900mm	Brushed Nickel	<ul style="list-style-type: none"> • For use with handheld showers • Smooth PVC hose with elastic inner supported by polyester cords • 1 x ½" BSP swivel and 1 x ½" BSP fixed conical end nuts • Brushed Nickel finish
	SH 1200 BN	1200mm	Brushed Nickel	
	SH 1500 BN	1500mm	Brushed Nickel	
	SH 2000 BN	2000mm	Brushed Nickel	
ANTIMICROBIAL SMOOTH SURFACE HOSE - PVC				
	SH 0900 AW	900mm	Antimicrobial White	<ul style="list-style-type: none"> • For use with handheld showers • Smooth PVC hose with antimicrobial inner • Non-phthalate flexible PVC outer with antimicrobial additive • 1 x ½" BSP swivel and 1 x ½" BSP fixed conical end nuts
	SH 1200 AW	1200mm	Antimicrobial White	
	SH 1500 AW	1500mm	Antimicrobial White	
	SH 2000 AW	2000mm	Antimicrobial White	
REINFORCED SOFTFLEX® SMOOTH SURFACE HOSE - PVC				
	SH 0900 WR	900mm	Reinforced White	<ul style="list-style-type: none"> • For use with handheld showers • Smooth PVC hose with elastic inner strengthened by woven polyester cords • 1 x ½" BSP swivel and 1 x ½" BSP fixed conical end nuts • White reinforced hose with chrome plated brass components
	SH 1200 WR	1200mm	Reinforced White	
	SH 1500 WR	1500mm	Reinforced White	
	SH 2000 WR	2000mm	Reinforced White	
METAL HOSE DOUBLE HOOK & LOOP - AGRAFF				
	SH 1500 C ME	1500mm	Chrome	<ul style="list-style-type: none"> • For use with handheld showers • Spiral metal hose with elastic inner • Double hook and loop (Agraff) outer casing • ½" BSP fixed conical end nuts • Chrome plated finish
	SH 2000 C ME	2000mm	Chrome	
HOSE FOR TWIN WATERS™ SHOWERS - PVC				
	SH 1500 BN TW	1500mm	Brushed Nickel	<ul style="list-style-type: none"> • For use with Riviera and Twin Waters™ rails • Elastic inner with polyester cords and nylon smooth hose and clear PVC outer sheath • 1 x ½" BSP swivel conical end nut and 1 x ½" BSP Twin Waters™ hose nut
	SH 1500 CS TW	1500mm	Chrome Silverflex®	
	SH 1500 MB TW	1500mm	Matte Black	
PVC SMOOTH SHOWER HOSE - BULK				
	SH 0025 AW	25m	Antimicrobial White	<ul style="list-style-type: none"> • 25m • For use with handheld showers • Smooth PVC hose with elastic inner supported by polyester cords
	SH 0025 CS	25m	Chrome Silverflex®	
	SH 0025 MB	25m	Matte Black	
	SH 0025 WR	25m	Reinforced White	
PVC SPIRAL SHOWER HOSE - BULK				
	SH 0025 WT	25m	Softflex® White	<ul style="list-style-type: none"> • 25m • For use with handheld showers • Spiral PVC hose with elastic inner supported by polyester cords

SPARE PARTS

SHOWER HOSE PARTS

Con-Serv stock a range of hose spare parts and accessories. Items can be purchased individually, or as part of our Tradesman Hose Repair Kits which can be topped up as required.

	Code	Finish	Features	
EEL GRIP SEALS (20 PACK)				
	SH 027 GR EG	Green	<ul style="list-style-type: none"> Eel Grip Seal - Delrin 20 pack For use with shower hoses 	
WASHERS - NITRIL N70 (20 PACK)				
	SH 027 BL HW	Black	<ul style="list-style-type: none"> Washers - EPDM 20 Pack For use with handheld showers 	
HOSE SLEEVES - 14mm/15mm (20 PACK)				
	SH 027 C SV	Grey 14mm	<ul style="list-style-type: none"> Available in 14mm ID (20 pack) or 15mm ID (20 pack) 	
	SH 027 C LV	Grey 15mm		
CONICAL END NUTS (10 PACK)				
	SH 027 C CN	Chrome	<ul style="list-style-type: none"> ½" BSP female 10 pack Chrome plated finish 	
TRADESMAN HOSE REPAIR KIT				
	SH 027 TR	Tool Kit	<p>CONTENTS:</p> <ul style="list-style-type: none"> 1 x Hose repair hand vice tool 1 x Trimming Knife 20 x 14mm Hose sleeves 40 x Hose gaskets 20 x 15mm Hose sleeves 1 x 3.5m Tape measure 20 x Hose seal plugs 10 x Conical end nuts Instructions included 	
SWITCHCOCK VALVE				
	DV 021 C	Chrome	<ul style="list-style-type: none"> Two-way switchcock diverter valve Brass construction ½" BSP female threaded inlet with front and bottom ½" BSP male threaded outlets Suitable for installation where a fixed overhead shower and handheld shower are required Not to be used as a line end stop control 	
HOSE RESTRICTOR BRACKET				
	HR 015 BN	Brushed Nickel	<ul style="list-style-type: none"> Wall mounted hose retainer Suited to accessible showers with 1500mm hose in close proximity to WC Dual screw wall mount plate Stainless steel fixings supplied 	
	HR 015 C	Chrome		
	HR 015 MB	Matte Black		
HOB MOUNT SET				
	HM 019 C	Chrome	<ul style="list-style-type: none"> ABS 50mm bench mount collar with 26mm continuous thread and lock nut PVC 1500mm reinforced hose with ½" BSP swivel conical end nut Shower sold separately This product may need future service. Ensure an access panel is installed when fitting to spa baths and tubs. <p>Con-Serv recommends a DC 043 (page 48) dual check prevention valve is installed with this product.</p>	
	HM 019 WTC	White/Chrome		



Flow Control Valves

In plumbing, a flow control valve regulates the flow of water from an open outlet like a kitchen or bathroom tap. Flow control valves are generally small in size and vary in function and shape, so it is important to understand what and where you are installing to ensure you get the correct device. All Con-Serv flow control valves feature a constant flow regulator which ensures a guaranteed nominal flow rate e.g. 9L/min irrespective of the pressure (the force) behind the water. In Australia, the average working pressure range in most households is generally 350kPa (kilopascals), however Con-Serv valves will function at a low 150kPa through to a high of 500kPa. Con-Serv stock a range of flow control devices including Aerators, Inline Flow Control Valves and Dual Check/Non-Return Valves.

WELS

About the Water Efficiency Labelling and Standards scheme

The Water Efficiency Labelling and Standards (WELS) scheme is Australia's urban water saving scheme. The WELS scheme uses a rating system to help consumers make informed choices about the water efficiency of products they purchase.

WELS estimates show that using water efficient products could save Australians more than \$2 billion by 2030, with an average saving of \$175 per household each year.

- 65% of these savings are from reduced electricity and gas costs from avoided water heating
- 35% of these savings are from reduced water bills

Management of the scheme is the responsibility of the Department of Agriculture and Water Resources, working in partnership with industry and state and territory governments.

The purpose of the WELS scheme is to:

- Conserve water supplies by reducing water consumption;
- Promote the adoption of efficient and effective water-using and water saving technologies; and
- Provide information for purchasers of water-using and water saving products.

WELS achieve these objectives by specifying and enforcing standards for water efficiency and labelling for a range of regulated water-using appliances, fixtures and fittings.

To learn more about WELS visit www.waterrating.gov.au

WaterMark

What is the WaterMark Certification Scheme

The WaterMark Certification Scheme is a mandatory certification scheme for plumbing and drainage products. Certification ensures products are fit for purpose and appropriately authorised for use in plumbing and drainage installations. The Australian Building Codes Board administers and manages the Scheme.

To install plumbing and drainage products in Australia, including those purchased via online stores like eBay and Amazon, the product must be:

- WaterMark certified;
- Marked with the WaterMark trade mark, WaterMark licence number and the applicable product specification;
- Listed on the WaterMark product database and provided with a Scope of Use statement specifying its intended use; and
- Any associated product packaging and promotional material must also be marked with the WaterMark trademark and licence number.

Although it is legal to sell and buy non-WaterMark certified plumbing products in Australia, if the product is not WaterMark certified, a licensed plumber is not permitted to install it.

All Con-Serv flow control devices are WaterMarked AS/NZS 2845.1 WMKA 02696; AS 5200.037.2 WMKA 00667; ATS 5200.012 WMKA 21148 or WMTS 479 WMK 25895.

To learn more about WaterMark certification, visit www.watermark.abcb.gov.au

Aerators

Aerators are found in most kitchen and bathroom outlets, and are a key component in the overall performance of the tap.

They work by:

- Controlling the water stream straightness and diameter;
- Reducing splash by aerating the stream and eliminating side spray; and
- Saving water, and reducing energy costs by restricting the flow rate.

Con-Serv Aerator inserts are available in Bubble Spray, Laminar and Stream Spray, and in a range of flow rates from as little as 2L/min. Con-Serv stock aerators in standard (21mm) and Tiny Man (15mm) sizes, in both male and female configurations.

See our full range of Aerators pages 42-44

Measuring Devices

There are many reasons why you might need to measure the water flow rate of your kitchen or bathroom taps and showers, particularly if you are replacing existing fittings or problem-solving potential water-waste culprits.

Checking your water flow rate is easy when you have the right tools – like Con-Serv’s Basin Water Flow Measuring Cup and Shower Flow Measuring Jug.

See our range of Measuring Devices on page 47.



Flow Control Valves

Con-Serv stock a range of flow control valves including Inline Flow Control Valves, Dual Check/Non-Return Valves and Flood Stop Valves. All Con-Serv flow control valves feature a constant flow regulator for guaranteed flow rate.

Inline Flow Control Valves

Inline flow controls connect directly to hose tails or compression nut with olive, fitting between connections where an end of line (outlet) fitting is not possible.

Dual Check Valves

Dual Check/Non-Return valves allows flow in one direction and automatically prevent backflow (reverse flow) from occurring when fluid in the line is drawn elsewhere.

Flood Stop Valves

The ¾" F&M brass flood stop valve prevent uncontrolled water flow from burst pressure hoses used for supply to domestic dish washing and washing machines. The safety valve will close and shut off the water when the flow is greater than 17L/min.

Con-Serv Flow Control Valves are available in a range of flow rates to suit a variety of situations.

See our range of Flow Control Valves pages 45-46.

Meter-Beater®

Meter-Beater® is a complete system that provides a new seat and seal mechanism with integral flow control for screw down taps and is flow controlled to regulate flow rate, reduce plumbing noise and to eliminate excess water use.

Meter-Beater® is exclusive to Con-Serv and is available in a variety of flow rates from as little as 2L/min. Meter-Beater® is WaterMarked AS 5200.037.2 WMKA 00667 and WELS rated as per licence number 0046.

See the Meter-Beater® range on page 47.

FLOW CONTROL

Aerators	42
Flow Valves	45
Control Valves, Regulators and Spigots	45
Dual Check/Non-Return Valves.....	46
Flood Stop Valves	46
Meter-Beater® Tap Components	47
Measuring Devices.....	47

Aerators are a simple and effective way to help reduce your water usage while maintaining great pressure. Con-Serv has a extensive range to meet your needs. All Con-Serv aerators are WaterMarked AS 5200.037.2 WMKA 00667 and WELS rated as per licence number 0046.



	Code	Finish	Flow Rate	Features
AERATOR INSERT - BUBBLE SPRAY				
	AF 5FVB	Grey	5 Star 6L/min	<ul style="list-style-type: none"> • Bubble spray aerator flow valve insert • WaterMark AS 5200.037.2 WMKA 00667 • WELS licence number 0046
	AF 8FVB	Grey	3 Star 9L/min	
AERATOR INSERT - LAMINAR				
	AF 5FVL	Grey	5 Star 6L/min	<ul style="list-style-type: none"> • Laminar flow valve insert • Screenless • WaterMark AS 5200.037.2 WMKA 00667 • WELS licence number 0046
	AF 8FVL	Grey	3 Star 9L/min	
AERATOR INSERT - LAMINAR (ANTIMICROBIAL)				
	AF 5ALF	Grey	5 Star 6L/min	<ul style="list-style-type: none"> • Laminar flow valve insert • Antimicrobial additive reduces surface biofilm and bacteria build-up • Antimicrobial protection Ag+ Plus • WaterMark AS 5200.037.2 WMKA 00667 • WELS licence number 0046
	AF 8ALF	Grey	3 Star 9L/min	
AERATOR INSERTS - LAMINAR (CLINIC COLOUR CODED)				
	AF 5CLL BE	Blue	5 Star 6L/min	<ul style="list-style-type: none"> • Laminar (non-aerated), splash-free, crystal clear flow insert • Colour coded to support a maintenance cycle • WaterMark AS 5200.037.2 WMKA 00667 • WELS licence number 0046
	AF 5CLL GR	Green	5 Star 6L/min	
	AF 5CLL RD	Red	5 Star 6L/min	
	AF 5CLL YE	Yellow	5 Star 6L/min	
AERATOR INSERT - STREAM SPRAY				
	AF 2FVS	Grey	6 Star 2L/min	<ul style="list-style-type: none"> • Stream spray aerator flow valve insert • WaterMark AS 5200.037.2 WMKA 00667 • WELS licence number 0046
	AF 5FVS	Grey	5 Star 6L/min	
M15 AERATOR TINY MAN INSERT - BUBBLE SPRAY				
	AF 5TMB	Grey	5 Star 6L/min	<ul style="list-style-type: none"> • 15mm bubble spray flow control aerator insert • WaterMark AS 5200.037.2 WMKA 00667 • WELS licence number 0046
	AF 8TMB	Grey	3 Star 9L/min	
M15 AERATOR TINY MAN INSERT - LAMINAR				
	AF 5TML	Grey	5 Star 6L/min	<ul style="list-style-type: none"> • Laminar (non-aerated), splash-free, crystal clear flow insert • Metric M15 size • WaterMark AS 5200.037.2 WMKA 00667 • WELS licence number 0046
M16 AERATOR (FEMALE) MINI VALVE - BUBBLE SPRAY				
	AF 15DFB C/05	Chrome	5 Star 6L/min	<ul style="list-style-type: none"> • Female threaded bubble spray flow control aerator for metric 16mm male threaded spouts • WaterMark AS 5200.037.2 WMKA 00667 • WELS licence number 0046
	AF 15DFB C/08	Chrome	3 Star 9L/min	

FLOW CONTROL AERATORS

Aerators are a simple and effective way to help reduce your water usage while maintaining great pressure. Con-Serv has a extensive range to meet your needs. All Con-Serv aerators are WaterMarked AS 5200.037.2 WMKA 00667 and WELS rated as per licence number 0046.

	Code	Finish	Flow Rate	Features
M18 AERATOR (MALE) MINI VALVE - LAMINAR				
	AF 15DMB C/05	Chrome	5 Star 6L/min	<ul style="list-style-type: none"> Female threaded bubble spray flow control aerator for metric 24 male threaded spouts WaterMark AS 5200.037.2 WMKA 00667 WELS licence number 0046
	AF 15DMB C/08	Chrome	3 Star 9L/min	
M22 AERATOR (FEMALE) - BUBBLE SPRAY				
	AF 22DFB C/05	Chrome	5 Star 6L/min	<ul style="list-style-type: none"> Female threaded bubble spray flow control aerator for metric 24 male threaded spouts WaterMark AS 5200.037.2 WMKA 00667 WELS licence number 0046
	AF 22DFB C/08	Chrome	3 Star 9L/min	
M22 AERATOR (FEMALE) - BUBBLE SPRAY (ANTI-VANDAL)				
	AF 22VFB C/05	Chrome	5 Star 6L/min	<ul style="list-style-type: none"> Female threaded bubble spray flow control aerator for metric 24 male threaded spouts For installation where vandalism is a consideration Anti-vandal fitting key supplied WaterMark AS 5200.037.2 WMKA 00667 WELS licence number 0046
	AF 22VFB C/08	Chrome	3 Star 9L/min	
M22 AERATOR (FEMALE) - LAMINAR				
	AF 22DFL C/05	Chrome	5 Star 6L/min	<ul style="list-style-type: none"> Female threaded laminar flow control aerator for metric 24 male threaded spouts WaterMark AS 5200.037.2 WMKA 00667 WELS licence number 0046
	AF 22DFL C/08	Chrome	3 Star 9L/min	
M22 AERATOR (FEMALE) - STREAM SPRAY				
	AF 22DFS C/02	Chrome	6 Star 2L/min	<ul style="list-style-type: none"> Female threaded stream spray flow control aerator for metric 24 male threaded spouts WaterMark AS 5200.037.2 WMKA 00667 WELS licence number 0046
	AF 22DFS C/05	Chrome	5 Star 6L/min	
M22 AERATOR (FEMALE) - STREAM SPRAY (ANTI-VANDAL)				
	AF 22VFS C/02	Chrome	6 Star 2L/min	<ul style="list-style-type: none"> Female threaded stream spray flow control aerator for metric 24 male threaded spouts For installation where vandalism is a consideration Anti-vandal fitting key supplied WaterMark AS 5200.037.2 WMKA 00667 WELS licence number 0046
	AF 22VFS C/05	Chrome	5 Star 6L/min	
M22 AERATOR (FEMALE) - SINK SWIVEL				
	AF 20 C	Chrome	3 Star 9L/min	<ul style="list-style-type: none"> Premium female sink spray aerator Metric 22 threaded brass ball joint for fitting to male thread outlet spouts Novodur P2MC natural ABS plastic housing For use with cold and hot water up to 85°C Adaptor supplied for male/female connection WaterMark AS 5200.037.2 WMKA 00667 WELS licence number 0046
M22 AERATOR (FEMALE) - ADAPTOR				
	AF 22F C/04	Chrome	6 Star 4.5L/min	<ul style="list-style-type: none"> DR brass female threaded aerator flow control adaptor for metric 22 female threaded aerators Fit to male threaded outlet spouts WaterMark AS 5200.037.2 WMKA 00667 WELS licence number 0046
	AF 22F C/06	Chrome	5 Star 6L/min	
	AF 22F C/09	Chrome	3 Star 9L/min	
	AF 22F C/12	Chrome	2 Star 12L/min	

FLOW CONTROL AERATORS

Aerators are a simple and effective way to help reduce your water usage while maintaining great pressure. Con-Serv has a extensive range to meet your needs. All Con-Serv aerators are WaterMarked AS 5200.037.2 WMKA 00667 and WELS rated as per licence number 0046.



	Code	Finish	Flow Rate	Features
M24 AERATOR (MALE) - BUBBLE SPRAY				
	AF 24DMB C/05	Chrome	5 Star 6L/min	<ul style="list-style-type: none"> • Male threaded bubble spray flow control aerator for metric 22 female threaded spouts • WaterMark AS 5200.037.2 WMKA 00667 • WELS licence number 0046
	AF 24DMB C/08	Chrome	3 Star 9L/min	
M24 AERATOR (MALE) - BUBBLE SPRAY (ANTI-VANDAL)				
	AF 24VMB C/05	Chrome	5 Star 6L/min	<ul style="list-style-type: none"> • Male threaded bubble spray flow control aerator for metric 22 female threaded spouts • For installation where vandalism is a consideration • Anti-vandal fitting key supplied • WaterMark AS 5200.037.2 WMKA 00667 • WELS licence number 0046
	AF 24VMB C/08	Chrome	3 Star 9L/min	
M24 AERATOR (MALE) - LAMINAR				
	AF 24DML C/05	Chrome	5 Star 6L/min	<ul style="list-style-type: none"> • Male threaded laminar flow control aerator for metric 22 female threaded spouts • WaterMark AS 5200.037.2 WMKA 00667 • WELS licence number 0046
	AF 24DML C/08	Chrome	3 Star 9L/min	
M24 AERATOR (MALE) - STREAM SPRAY				
	AF 24DMS C/02	Chrome	6 Star 2L/min	<ul style="list-style-type: none"> • Male threaded stream spray flow control aerator for metric 22 female threaded spouts • WaterMark AS 5200.037.2 WMKA 00667 • WELS licence number 0046
	AF 24DMS C/05	Chrome	5 Star 6L/min	
M24 AERATOR (MALE) - STREAM SPRAY (ANTI-VANDAL)				
	AF 24VMS C/02	Chrome	6 Star 2L/min	<ul style="list-style-type: none"> • Male threaded stream spray flow control aerator for metric 22 female threaded spouts • For installation where vandalism is a consideration • Anti-vandal fitting key supplied • WaterMark AS 5200.037.2 WMKA 00667 • WELS licence number 0046
	AF 24VMS C/05	Chrome	5 Star 6L/min	
M24 AERATOR (MALE) - ADAPTOR				
	AF 24M C/04	Chrome	6 Star 4.5L/min	<ul style="list-style-type: none"> • DR brass male threaded aerator flow control adaptor for metric 24 male threaded aerators • Fit to female threaded outlet spouts • WaterMark AS 5200.037.2 WMKA 00667 • WELS licence number 0046
	AF 24M C/06	Chrome	5 Star 6L/min	
	AF 24M C/09	Chrome	3 Star 9L/min	
	AF 24M C/12	Chrome	2 Star 12L/min	
AERATOR UNIVERSAL SERVICE KEY				
	AF 00 UNK	Chrome		<ul style="list-style-type: none"> • Universal service key • Suitable for all standard aerator sizes • Metric Housings M18, M22, M24 and M28 • CACHE models TT, TJ, TF, JR and STD
AERATOR ANTI-VANDAL FITTING KEY				
	AF 00 VK	Stainless Steel		<ul style="list-style-type: none"> • Anti-vandal fitting key suits M22 Female and M24 Male housings

FLOW CONTROL FLOW VALVES

Designed to deliver a constant water flow, our range of all-purpose flow regulated valves are available in a range of finishes and flow rates, to suit every flow control situation. All Con-Serv flow valves are WaterMarked AS 5200.037.2 WMKA 00667 and WELS rated as per licence number 0046.

	Code	Finish	Flow Rate	Features
BASIN FLOW CONTROL VALVE				
	AF 053 C/04	Chrome	6 Star 4.5L/min	<ul style="list-style-type: none"> • ½" M & F brass 35mm long constant flow regulator valve • ½" BSP female outlet • Designed to accept hose tails of compression nut and olive • WaterMark AS 5200.037.2 WMKA 00667 • WELS licence number 0046
	AF 053 C/06	Chrome	5 Star 6L/min	
	AF 053 C/09	Chrome	3 Star 9L/min	
	AF 053 C/12	Chrome	2 Star 12L/min	
FLANGE FLOW CONTROL VALVE				
	AF 055 C/02	Chrome	6 Star 2L/min	<ul style="list-style-type: none"> • ½" F & M DR brass sculptured flange • 35mm long x 57mm diameter constant flow regulator • ½" BSP female inlet and ½" BSP male outlet • WaterMark AS 5200.037.2 WMKA 00667 • WELS licence number 0046
	AF 055 C/04	Chrome	6 Star 4.5L/min	
	AF 055 C/06	Chrome	5 Star 6L/min	
	AF 055 C/09	Chrome	3 Star 9L/min	
	AF 055 C/12	Chrome	2 Star 12L/min	
FLOW CONTROL DISC				
	AF 019 B/06	Brass	5 Star 6L/min	<ul style="list-style-type: none"> • DR brass 19mm Flow control disc • WaterMark AS 5200.037.2 WMKA 00667 • WELS licence number 0046
	AF 019 B/09	Brass	3 Star 9L/min	
	AF 019 B/12	Brass	2 Star 12L/min	
FLOW CONTROL VALVE				
	AF 054 C/02	Chrome	6 Star 2L/min	<ul style="list-style-type: none"> • ½" F & M DR brass 35mm long flow regulator valve • ½" BSP female inlet, ½" BSP male outlet • Designed to accept hose tails or compression nut and olive • WaterMark AS 5200.037.2 WMKA 00667 • WELS licence number 0046
	AF 054 C/04	Chrome	6 Star 4.5L/min	
	AF 054 C/06	Chrome	5 Star 6L/min	
	AF 054 C/09	Chrome	3 Star 9L/min	
	AF 054 C/12	Chrome	2 Star 12L/min	
FLOW INTERCHANGE® SPIGOT ½"				
	AF 086 RB/06	Brass	6L/min	<ul style="list-style-type: none"> • Exclusive ½" DR brass outlet for connection to Con-Serv's bathroom water flow spigot body inlets • Eliminates damage to tiles and wall plates and aids alignment when installing shower bathroom products
	AF 086 RB/09	Brass	9L/min	
	AF 086 RB/12	Brass	12L/min	
	AF 086 RB/15	Brass	15L/min	
	AF 086 RB/FF	Brass	Full Flow	
M&F HOSE TAP FLOW REGULATOR ¾"				
	AF 059 C/06	Chrome	5 Star 6L/min	<ul style="list-style-type: none"> • ¾" M & F DR brass (20mm) hose cock flow regulator • Also suitable for use with water using appliances having ¾" BSP hose connections • Ideal for top-loading washing machines to limit flow when flood stop valves are installed • WaterMark AS 5200.037.2 WMKA 00667 • WELS licence number 0046
	AF 059 C/09	Chrome	3 Star 9L/min	
	AF 059 C/12	Chrome	2 Star 12L/min	
WHISPER WASH® - MK 1				
	AF 048 C/09	Chrome	9L/min	<ul style="list-style-type: none"> • ¾" F & M DR brass (20mm), 38mm long flow regulator non-return valve • For appliance noise reduction • Suitable for washing machines, dishwashers and all water-using appliances with ¾" BSP hose connections • WaterMark AS 5200.037.2 WMKA 00667

Protect your home or business with our Dual Check/Non-return and Flood Stop valves. Suitable for both domestic and commercial environments. All Con-Serv valves are WaterMarked AS 5200.037.2 WMKA 00667 and WELS rated as per licence number 0046.



Code Finish Flow Rate Features

DUAL CHECK / NON-RETURN VALVES

DUAL CHECK/NON-RETURN 1/2" M&F



DC 042 C/04	Chrome	6 Star 4.5L/min
DC 042 C/06	Chrome	5 Star 6L/min
DC 042 C/09	Chrome	3 Star 9L/min
DC 042 C/12	Chrome	2 Star 12L/min
DC 042 C/FF	Chrome	Full Flow

- 1/2" BSP male inlet; 1/2" BSP female outlet
- Designed to accept compression nut and olive
- Operating temperature 1° - 60° Celsius
- Max. working pressure 1200 kPa for Full Flow
- Recommended working pressure 150-500 kPa
- Independently operating check valves
- Suitable for low hazard applications
- WaterMarked AS 5200.037.2 WMKA 00667 (Dual Check Flow Control) and AS/NZS 2845.1, Licence WMKA 02696 (Backflow Prevention Device)
- WELS licence number 0046

DUAL CHECK/NON-RETURN 1/2" F&M



BRUSHED NICKEL		
DC 043 BN/04	Brushed Nickel	6 Star 4.5L/min
DC 043 BN/06	Brushed Nickel	5 Star 6L/min
DC 043 BN/09	Brushed Nickel	3 Star 9L/min
DC 043 BN/12	Brushed Nickel	2 Star 12L/min
DC 043 BN/FF	Brushed Nickel	Full Flow
CHROME		
DC 043 C/04	Chrome	6 Star 4.5L/min
DC 043 C/06	Chrome	5 Star 6L/min
DC 043 C/09	Chrome	3 Star 9L/min
DC 043 C/12	Chrome	2 Star 12L/min
DC 043 C/FF	Chrome	Full Flow
MATTE BLACK		
DC 043 MB/04	Matte Black	6 Star 4.5L/min
DC 043 MB/06	Matte Black	5 Star 6L/min
DC 043 MB/09	Matte Black	3 Star 9L/min
DC 043 MB/12	Matte Black	2 Star 12L/min
DC 043 MB/FF	Matte Black	Full Flow

- 1/2" BSP female inlet; 1/2" BSP male outlet
- Designed to accept compression nut and olive
- Operating temperature 1° - 60° Celsius
- Max. working pressure 1200 kPa for Full Flow
- Recommended working pressure 150-500 kPa
- Independently operating check valves
- Suitable for low hazard applications
- WaterMarked AS 5200.037.2 WMKA 00667 (Dual Check Flow Control) and AS/NZS 2845.1, Licence WMKA 02696 (Backflow Prevention Device)
- WELS licence number 0046

DUAL CHECK/NON-RETURN 1/2" M&M



DC 057 C/04	Chrome	6 Star 4.5L/min
DC 057 C/06	Chrome	5 Star 6L/min
DC 057 C/09	Chrome	3 Star 9L/min
DC 057 C/12	Chrome	2 Star 12L/min
DC 057 C/FF	Chrome	Full Flow

- R 1/2" male inlet; R 1/2" male outlet
- Operating temperature 1° - 60° Celsius
- Max. working pressure 1200 kPa for Full Flow
- Recommended working range 150-500 kPa
- Independently operating check valves
- Suitable for low hazard applications
- WaterMarked AS 5200.037.2 WMKA 00667 (Dual Check Flow Control) and AS/NZS 2845.1, Licence WMKA 02696 (Backflow Prevention Device)
- WELS licence number 0046

FLOOD STOP VALVES

FLOOD STOP VALVE



FS 038 C	Chrome	N/A

- 3/4" F & M DR brass
- Prevents the uncontrolled water flow from burst hoses used for dishwashing and front load washing machines
- The safety valve will close and shut off the water when the flow is greater than 17L/min
- Minimum operating pressure 200 kPa static
- Maximum operating pressure 500 kPa static
- WaterMark WMTS 479 WMK 25895

FLOW CONTROL METER-BEATER® AND MEASURING DEVICES

Exclusive to Con-Serv, Meter-Beater® is a complete system that provides a new seat and seal mechanism with integral flow control for screw down taps to regulate flow rate and eliminate excess water use. Meter-Beater® is WaterMarked AS 5200.037.2 WMKA 00667 and WELS rated as per licence number 0046.

Code Finish/Flow Rate Features

METER-BEATER® TAP COMPONENTS

METER-BEATER® ½" CERAMIC DISC TAPWARE			
	MB 047/02	6 Star 2L/min	<ul style="list-style-type: none"> • Flow controlled DR brass valve • Seat insert 9/16th brass thread • 8mm hexagonal core • Suits ¼", ½" & ¾" turn ceramic disc tapware • WaterMark AS 5200.037.2 WMKA 00667 • WELS licence number 0046
	MB 047/04	6 Star 4.5L/min	
	MB 047/06	5 Star 6L/min	
	MB 047/09	3 Star 9L/min	
	MB 047/12	2 Star 12L/min	
METER-BEATER® ½" SCREW DOWN TAPWARE			
	MB 045/02	6 Star 2L/min	<ul style="list-style-type: none"> • For screw down tapware • Flow controlled DR brass valve • Seat insert 9/16th brass thread • 8mm hexagonal core, nitril rubber seal • Saves hot and cold water • Reduces plumbing noise • WaterMark AS 5200.037.2 WMKA 00667 • WELS licence number 0046
	MB 045/04	6 Star 4.5L/min	
	MB 045/06	5 Star 6L/min	
	MB 045/09	3 Star 9L/min	
	MB 045/12	2 Star 12L/min	
METER-BEATER® VALVE BODY O-RING SEAL			
	MB 045 OR01	Single	<ul style="list-style-type: none"> • Valve body nitril 70 O-ring seal for Meter-Beater® • Available in singles or packs of 10 or 20
	MB 045 OR10	10 Pack	
	MB 045 OR20	20 Pack	
METER-BEATER® INSTALLATION KIT			
	MB 043 IK	Pack	<ul style="list-style-type: none"> • Installation Kit Includes: <ul style="list-style-type: none"> - 9/16" tapping tool - Tapping tool guide - 8mm Allen key - Spindle flush plug
METER-BEATER® INSTALLATION TOOLS			
	MB 043 RT	Chrome	Meter-Beater® Reamer Tool
	MB 043 FP	Chrome	Meter-Beater® Spindle Flush Plug
	MB 043 TT	Chrome	Meter-Beater® Tapping Tool

MEASURING DEVICES

BASIN FLOW MEASURING CUP			
	FM 070 BE	Blue	<ul style="list-style-type: none"> • Measures flow rate from tapware • Test range 3L/min to 20L/min • Instructions available on the Con-Serv website, or scan QR code for more information
			
SHOWER FLOW MEASURING JUG			
	FM 075 BE	Blue	<ul style="list-style-type: none"> • Measures flow rate from showers • Test range 4.5L/min to 24L/min • Instructions available on the Con-Serv website, or scan QR code for more information
			



Safe-Assist Healthcare

Skills combined with innovative techniques and leading designs establish the enduring character for which Con-Serv is known. With 40 years' industry experience, Con-Serv has long been recognised as a leader in the healthcare industry with its Safe-Assist range of grab rails, toilet aids, accessible showers, folding shower seats, anti-ligature, bariatric and antimicrobial bathroom products. Whether you are looking for support rails for independent living installations, or something on a larger scale, Con-Serv have a range of domestic and commercial healthcare solutions to meet your needs.

Grab Rails

A grab rail is a safety device designed to enable users to maintain their balance, reduce fatigue while standing, and support users weight when moving between two places. They are commonly installed in high risk areas such as bathrooms to reduce the possibility of slipping or falling.

Designs for every style and budget

Whether you want the sophistication of a Linear rail, the hygienic benefits of an antimicrobial seal, or the affordability of a traditional clam flange, Con-Serv have the grab rail to suit your needs. Choose your profile preference and view our range of grab rails and healthcare showers.

All Con-Serv grab rails are fabricated from 32mm grade 304, 18/8 stainless steel and are supported by Con-Serv's 20 year domestic and 7 year commercial warranty.

The advantages of stainless steel grab rails

- **Corrosion, scratch and stain resistant.** Stainless steel contains a natural passive, chromium-rich, oxide film that forms on the surface of the steel. This invisible shield is self-renewing and acts as a protectant against corrosion and damage.
- **Easy to clean.** Stainless steel is non-porous and easy to clean. Never use chlorides, acids or steel wool. Simply wipe over the surface using a mild detergent or ammonia solution with a soft cloth for a perfect finish.
- **Durability.** Stainless steel is strong and easy to work with making it a cost effective and durable solution for grab rail manufacturing.

Grab rail profiles

Con-Serv grab rails are available in three standard profiles in addition to our specialty anti-ligature and bariatric grab rails. Each profile collection includes options for straight, accessible and shower recess grab rails in a range of sizes and finishes.



Clam® Flange

Our traditional Clam® Flange grab rail with standard 78mm domed flange cover.



Hygienic Seal®

Our premium grab rail with minimalist 50mm screw on flange cover featuring Biomaster Thermoplastic Elastomer seals.



Linear

Our Linear range, combines our Hygienic Seal® flange with a "T" leg linear flange for a stylish design ideal for all applications.

Grab Rail Showers

Con-Serv Healthcare Showers are a result of 40 years' designing innovative solutions for individuals that need extra assistance. Our Healthcare Shower Kits utilise our industry leading grab rails, combined with our custom designed sliders and water saving handpieces for a AS 1428.1:2021 compliant solution suitable for home and commercial applications.

Shower Sliders

Con-Serv offer a variety of sliders with handset options to meet independent needs. Choose from our Glide Slide with Clicklock™ cradle, Friction Slider for users with weakened arthritis grip, and our Push-PullMe® slider with rod for seated users, for a custom shower combination.

Shower Seats

When safety in the shower is paramount, Con-Serv shower seats are the industry recognised solution with rounded, smooth edges and seats that are foldable, self-draining and non-slip. Manufactured from grade 304 stainless steel, with High Density Polyethylene (HDPE) seat top and assembled with anti-drop tension hinges ensuring stability up to 160kg for our standard shower seats, and up to 400kg for our Bariatric shower seat.

[See our full range of Shower Seats pages 88-89.](#)

Anti-Ligature

Specially designed Anti-Ligature grab rails for use in bathrooms and accessible areas to mitigate the possibility of self-harm by patients in psychiatric clinics, hospitals and detention facilities.

Our fixed Anti-Ligature grab rails incorporate a 2.5mm grade 304 stainless steel plate centred 55mm from the back of the rail to wall, and continuously welded from flange to flange enabling secure rail access that is free of ligature points.

Our Anti-Ligature range also features a fixed wall shower and grab rail shower options with an anti-ligature slider and elbow.

[See our full range of Aerators pages 50-51.](#)

Antimicrobial *"Active against microbes"*

In developing our Antimicrobial range, antimicrobial additives have been infused into the product material during the manufacturing process. These additives work to attack the bacteria cell wall, interrupt cell metabolism and prevent bacteria reproduction extending the products hygienic properties and minimising the potential of cross-contamination.

Biomaster protected

Biomaster is a recognised leader of antimicrobial technology for plastics, fabrics and coatings. Look for the Biomaster symbol on our range.



[See our Antimicrobial range on pages 52-53.](#)

Bariatric

Bariatric healthcare specialises in serving and supporting users over 120kg to ensure a safe and accessible environment. Our bariatric range include increased weight capacities with additional support to meet the requirements of bariatric patients in areas such as toilets and showers.

The Con-Serv Bariatric range includes, Grab Rails, Folding Grab Rails, Grab Rail Showers and Shower Seats.

[See our full Bariatric range pages 56-59.](#)

AS 1428.1 Kits

In support of the 2021 release of the Australian Standards AS 1428.1:2021 Design for Access and Mobility, Con-Serv have developed a series of Combination Kits that meet needs for Accessible Sanitary Facilities, Accessible Shower Recess, Accessible Combined Sanitary Facilities (Section 12) and Ambulant Accessible Sanitary Compartments (Section 13).

[See our AS 1428.1 Combination Kits pages 102-109.](#)

SAFE-ASSIST HEALTHCARE

Anti-Ligature Collection	50
Antimicrobial Collection	52
Backrests - Accessible Toilet Assist	54
Bariatric Collection	56
Clam® Flange Collection	60
Hygienic Seal® Collection	66
Linear Collection.....	80
Shower Seats.....	88
Folding, Swing and Floor/Wall Grab Rails	90
Spare Parts and Accessories	92
AS 1428.1:2021 Combination Kits	102

Anti-Ligature Collection

	Code	Finish	Features
ANTI-LIGATURE VERTICAL GRAB RAILS			
	450MM		<ul style="list-style-type: none"> • 450mm, 600mm, 900mm and 1200mm, centre to centre • Vertical design for WC's and accessible areas in psychiatric clinics, hospitals and detention facilities • Mitigates the possibility of self-harm by patients • 2.5mm barrier plate featuring continuous weld • Fabricated from 38mm 304 stainless steel • Exposed fixings • Tamper resistant hex socket Post Torx screws supplied • Generally meets the requirements of AS 1428.1:2021 Design for access and mobility
	AL 450 AW VL	Antimicrobial White	
	AL 450 BS VL	Brushed Stainless	
	600MM		
	AL 600 AW VL	Antimicrobial White	
	AL 600 BS VL	Brushed Stainless	
	900MM		
	AL 900 AW VL	Antimicrobial White	
	AL 900 BS VL	Brushed Stainless	
	1200MM		
	AL 1200 AW VL	Antimicrobial White	
	AL 1200 BS VL	Brushed Stainless	
			Security hex socket

	Code	Finish	Features		
ANTI-LIGATURE HORIZONTAL GRAB RAILS					
	450MM		<ul style="list-style-type: none"> • 450mm, 600mm, 900mm and 1200mm, centre to centre • Horizontal design for WC's and accessible areas in psychiatric clinics, hospitals, and detention facilities • Mitigates the possibility of self-harm by patients • Unique open-end trough design makes cleaning easy • Fabricated from 38mm 304 stainless steel • Exposed fixings • Tamper resistant hex socket POST TORX screws supplied • Generally meets the requirements of AS 1428.1:2021 Design for access and mobility 		
	AL 450 AW HZ LH	Antimicrobial White			
	AL 450 AW HZ RH	Antimicrobial White			
	AL 450 BS HZ LH	Brushed Stainless			
	AL 450 BS HZ RH	Brushed Stainless			
	600MM				
	AL 600 AW HZ LH	Antimicrobial White			
	AL 600 AW HZ RH	Antimicrobial White			
	AL 600 BS HZ LH	Brushed Stainless			
	AL 600 BS HZ RH	Brushed Stainless			
	900MM				
	AL 900 AW HZ LH	Antimicrobial White			
	AL 900 AW HZ RH	Antimicrobial White			
	AL 900 BS HZ LH	Brushed Stainless			
	AL 900 BS HZ RH	Brushed Stainless			
	1200MM				
	AL 1200 AW HZ LH	Antimicrobial White			
	AL 1200 AW HZ RH	Antimicrobial White			
	AL 1200 BS HZ LH	Brushed Stainless			
	AL 1200 BS HZ RH	Brushed Stainless			
				Security hex socket	

	Code	Finish	Features	
ANTI-LIGATURE 90° AMBULANT AND ACCESSIBLE GRAB RAILS 450MM X 450MM				
<p>For ambulant disabilities</p>	AL 454 AW LH	Antimicrobial White	<ul style="list-style-type: none"> • 450mm x 450mm Anti-Ligature Toilet Assist Grab Rail • For use in WC's and other accessible areas in psychiatric clinics, hospitals and detention facilities • Mitigates the possibility of self-harm by patients • Unique open end trough design makes cleaning easy • Fabricated from 38mm 304 stainless steel • Exposed fixings • Tamper resistant hex socket POST TORX screws supplied • Generally meets the requirements of AS 1428.1:2021 Design for access and mobility 	
	AL 454 AW RH	Antimicrobial White		
	AL 454 BS LH	Brushed Stainless		
	AL 454 BS RH	Brushed Stainless		
			Security hex socket	

	Code	Finish	Features	
ANTI-LIGATURE 90° AMBULANT AND ACCESSIBLE GRAB RAILS 960MM X 600MM				
<p>For ambulant disabilities</p>	AL 966 AW LH	Antimicrobial White	<ul style="list-style-type: none"> • 960mm x 600mm Anti-Ligature Toilet Assist Grab Rail • For use in WC's and other accessible areas in psychiatric clinics, hospitals, and detention facilities • Mitigates the possibility of self-harm by patients • Unique open end trough design makes cleaning easy • Fabricated from 38mm 304 stainless steel • Exposed fixings • Tamper resistant hex socket POST TORX screws supplied • Generally meets the requirements of AS 1428.1:2021 Design for access and mobility 	
	AL 966 AW RH	Antimicrobial White		
	AL 966 BS LH	Brushed Stainless		
	AL 966 BS RH	Brushed Stainless		
			Security hex socket	

ANTI-LIGATURE COLLECTION SHOWER KITS

Specially designed 38mm Anti-Ligature grab rails with barrier for use in accessible areas to mitigate the possibility of self-harm by patients in hospitals, psychiatric clinics and detention facilities. Generally meets the requirements of AS 1428.1:2021 Design for access and mobility.

	Code	Finish	Features
ANTI-LIGATURE SHOWER KIT 6			
	AL 01806 AW	Antimicrobial White	<ul style="list-style-type: none"> • White Acetal 38mm load sensitive handset cradle for shower support and height adjustment • ABS chrome Hosficare® single function shower with full pattern spray and rub-clean spray diffuser • PVC 1500mm hose with ½" BSP swivel conical nut • Chrome DR Brass anti-ligature wall outlet elbow featuring force release mechanism when 10kg of weight is applied • Licenced dual check/non-return as per WaterMark AS/NZS 2845.1 WMKA 02696 • WaterMark AS 3662 WMKT 21147 • Available in 3 Star 9L/min and 4 Star 6.5L/min as per WELS licence number 0046 • Grab rail not included
	AL 01806 AW/6.5	Antimicrobial White	
	AL 01806 C	Chrome	
	AL 01806 C/6.5	Chrome	
ANTI-LIGATURE SHOWER KIT 9			
	AL 01809 AW	Antimicrobial White	<ul style="list-style-type: none"> • Anti-Ligature 900mm grab rail • White Acetal 38mm load sensitive handset cradle for shower support and height adjustment • ABS chrome® single function shower with full pattern spray and rub-clean spray diffuser • PVC 1500mm hose with ½" BSP swivel conical nut • Licenced dual check/non-return as per WaterMark AS/NZS 2845.1 WMKA 02696 • Chrome DR Brass anti-ligature wall outlet elbow featuring force release mechanism when 10kg of weight is applied • WaterMark AS 3662 WMKT 21147 • Available in 3 Star 9L/min and 4 Star 6.5L/min as per WELS licence number 0046
	AL 01809 AW/6.5	Antimicrobial White	
	AL 01809 C	Chrome	
	AL 01809 C/6.5	Chrome	
COBRA ANTI-LIGATURE / VANDAL RESISTANT SHOWER			
	CS 007 C	Chrome	<ul style="list-style-type: none"> • Vandal resistant/Anti-ligature design • 17° angle design, free from ligature points and attached with grub screws for tamper resistant installation • Brass 59mm shower body • 316 stainless steel (marine grade) 27mm jet spray diffuser • Flow Interchange® spigot • Full pattern spray • Maximum spray projection 940mm from 1850mm height • Ideal for correctional, mental health and rehabilitation centres • WaterMark AS 3662 WMKT 21147 • Available in 3 Star 9L/min and 4 Star 6.5L/min as per WELS licence number 0046
	CS 007 C/6.5	Chrome	

Antimicrobial Collection



Biomaster Thermoplastic Elastomer seals for added protection against bacteria

	Code	Finish	Features
ANTIMICROBIAL AERATOR INSERTS			
	WELS 5 STAR 6L/MIN		<ul style="list-style-type: none"> Laminar flow valve insert Antimicrobial additive reduces surface biofilm and bacteria build-up Antimicrobial protection Ag+ Plus WaterMark AS 5200.037.2 WMKA 00667 Available in 3 Star 9L/min and 5 Star 6L/min as per WELS licence number 0046
	AF 5ALF	Grey - 6L/min	
	WELS 3 STAR 9L/MIN		
	AF 8ALF	Grey - 9L/min	
ANTIMICROBIAL HANDSET CRADLE			
	HC 024 AW	Antimicrobial White	<ul style="list-style-type: none"> ABS handset cradle for 32mm grab rail Clicklock™ claw mechanism for tilt angle ABS construction with Biomaster antimicrobial additive White body, handset cradle, and lock nut
ANTIMICROBIAL HOSCARÉ® HANDPIECE			
	HP 030 AW	Antimicrobial White	<ul style="list-style-type: none"> ABS 100mm single function shower with Biomaster antimicrobial additive Concentric full pattern spray Rub-clean spray diffuser WaterMark AS 3662 WMKT 21147
ANTIMICROBIAL HOSES			
	SH 0900 AW	Antimicrobial White	<ul style="list-style-type: none"> 900mm, 1200mm, 1500mm, 2000mm, 3000mm and 4000mm hose lengths Antimicrobial hose with chrome plated brass end nuts Inner layer made from black TPE with Biomaster antimicrobial additive Outer layer is non-phthalate flexible PVC with Biomaster antimicrobial additive Smooth PVC hose with elastic inner strengthened by 1000 denier high tenacity polyester cord 1 x 1/2" BSP swivel and 1 x 1/2" BSP fixed conical end nuts Meets the performance requirements of AS/NZS 3662 clause 5.4
	SH 1200 AW	Antimicrobial White	
	SH 1500 AW	Antimicrobial White	
	SH 2000 AW	Antimicrobial White	
	SH 3000 AW	Antimicrobial White	
	SH 4000 AW	Antimicrobial White	
ANTIMICROBIAL FOLDING SHOWER SEAT			
	SS 964 AW ME	Antimicrobial White	<ul style="list-style-type: none"> Seat size: 960mm x 400mm Antimicrobial slatted seat deck AS 1428.1:2021 compliant Seat features self draining channels Maximum load 250kg Stainless steel fixing screws supplied

ANTIMICROBIAL COLLECTION SHOWER PARTS & SEAT

NEW

NEW

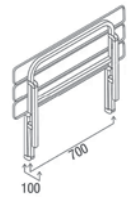

ANTIMICROBIAL COLLECTION SHOWER KITS

Highly effective against most common types of pathogenic bacteria, antimicrobial additives are infused into product during the manufacturing process inhibiting the growth of bacteria and microbes on surfaces, fabrics and coatings by up to 99.9%.



Learn more about our
Antimicrobial® range

	Code	Finish	Features
ANTIMICROBIAL SHOWER KIT 6			
<p>Biomaster PROTECTED</p> <p>Grab Rail not included</p> <p>NEW</p>	1500MM ANTIMICROBIAL HOSE		<ul style="list-style-type: none"> • Antimicrobial ABS Glide Slide cradle • Antimicrobial Hoscare® handpiece • Antimicrobial PVC shower hose • DR brass wall outlet elbow • 57mm solid brass round flat flange • Flow Interchange® spigot • Licenced dual check/non-return as per WaterMark AS/NZS 2845.1 WMKA 02696 • WaterMark AS 3662 WMKT 21147 • Available in 3 Star 9L/min and 4 Star 6.5L/min as per WELS licence number 0046
	HS 01806 AW	Antimicrobial White	
	HS 01806 AW/6.5	Antimicrobial White	
	2000MM ANTIMICROBIAL HOSE		
	HS 01806 AW2	Antimicrobial White	
	HS 01806 AW2/6.5	Antimicrobial White	
ANTIMICROBIAL SHOWER KIT 12			
<p>Biomaster PROTECTED</p> <p>NEW</p>	1500MM ANTIMICROBIAL HOSE		<ul style="list-style-type: none"> • Antimicrobial Hoscare® handpiece • Antimicrobial hose with ½" BSP swivel conical end nut • DR brass wall outlet elbow with flow Interchange® spigot • Brass 57mm wall flange • Licenced dual check/non-return as per WaterMark AS/NZS 2845.1 WMKA 02696 • WaterMark AS/NZS 3662 WMKT 21147 • Available in 3 Star 9L/min and 4 Star 6.5L/min as per WELS licence number 0046
	HS 01812 AW	Antimicrobial White	
	HS 01812 AW/6.5	Antimicrobial White	
	2000MM ANTIMICROBIAL HOSE		
	HS 01812 AW2	Antimicrobial White	
	HS 01812 AW2/6.5	Antimicrobial White	
ANTIMICROBIAL SHOWER			
<p>Biomaster PROTECTED</p> <p>NEW</p>	1500MM ANTIMICROBIAL HOSE		<ul style="list-style-type: none"> • 900mm Hygienic Seal® grab rail with Biomaster TPE seals • Antimicrobial ABS Glide Slide cradle (HC 024 AW) • Antimicrobial Hoscare® handpiece (HP 030 AW) • Antimicrobial PVC shower hose (SH 1500 AW) • Chrome plated DR brass wall outlet elbow • Flow Interchange® spigot • Licenced dual check/non-return as per WaterMark AS/NZS 2845.1 WMKA 02696 • 57mm solid brass round flat flange • Full pattern spray • WaterMark AS 3662 WMKT 21147 • Available in 3 Star 9L/min and 4 Star 6.5L/min as per WELS licence number 0046
	HS 01809 AW	Antimicrobial White	
	HS 01809 AW/6.5	Antimicrobial White	
	2000MM ANTIMICROBIAL HOSE		
	HS 01809 AW2	Antimicrobial White	
	HS 01809 AW2/6.5	Antimicrobial White	
<p>Options available on request</p> <ul style="list-style-type: none"> • ABS Grab Rail Soap Dish Holder - see page 94 			
<p>Model shown: HS 01809 AW</p>			

Backrests - Accessible Toilet Assist



FLOOR MOUNTED BACKRESTS



Code	Finish	Features
BR 395 BS	Brushed Stainless	<ul style="list-style-type: none"> • WC support device for disabled, aged and the infirmed • Suits all standard accessible suites with conventional pans (not wall faced) • Suits single accessible cubicle or combined accessible compartment featuring WC and shower recess grab rail • Polar White UV stabilised HDPE rounded edge back support • 78mm pre-formed domed Clam® Flange • Fabricated from 32mm 304 stainless steel • Stainless steel fixing screws supplied • Patent Number 2010100132 • Meets the requirements of AS 1428.1:2021 Design for access and mobility
BR 395 PS	Polish Supreme™	

- WC support device for disabled, aged and the infirmed
- Suits all standard accessible suites with conventional pans (not wall faced)
- Suits single accessible cubicle or combined accessible compartment featuring WC and shower recess grab rail
- Polar White UV stabilised HDPE rounded edge back support
- 78mm pre-formed domed Clam® Flange
- Fabricated from 32mm 304 stainless steel
- Stainless steel fixing screws supplied
- Patent Number 2010100132
- Meets the requirements of AS 1428.1:2021 Design for access and mobility

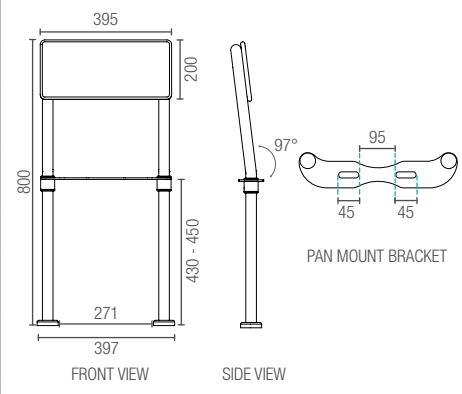

WALL MOUNTED BACKRESTS







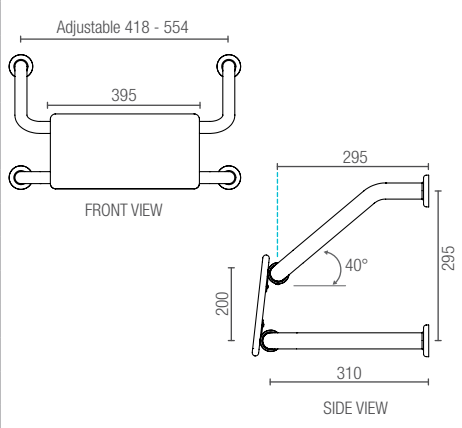



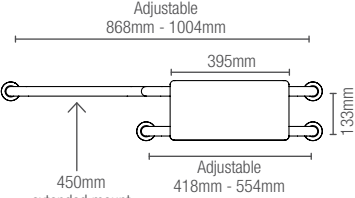
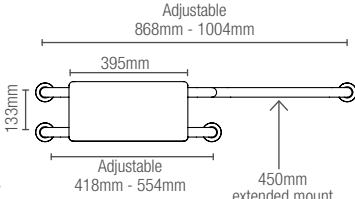

CLAM® FLANGE BACKRESTS (A)		Features
BR 400 BS CF	Brushed Stainless	
BR 400 PS CF	Polish Supreme™	
HYGIENIC SEAL® BACKRESTS (B)		<ul style="list-style-type: none"> • WC support device for disabled, aged and the infirmed • Suits single accessible cubicle or combined accessible compartment featuring WC and shower recess grab rail • Polar White UV stabilised HDPE rounded edge back support • Fabricated from 32mm 304 stainless steel • Stainless steel fixing screws supplied • Patent Number 2010101409 • Complies with section 12.2.4 of AS 1428.1:2021 for sanitary facilities
BR 400 BS HS	Brushed Stainless	
BR 400 MB HS	Matte Black	
BR 400 PS HS	Polish Supreme™	
BR 400 WT HS	White	

- WC support device for disabled, aged and the infirmed
- Suits single accessible cubicle or combined accessible compartment featuring WC and shower recess grab rail
- Polar White UV stabilised HDPE rounded edge back support
- Fabricated from 32mm 304 stainless steel
- Stainless steel fixing screws supplied
- Patent Number 2010101409
- Complies with section 12.2.4 of AS 1428.1:2021 for sanitary facilities



BACKRESTS ACCESSIBLE TOILET ASSIST

Robust 32mm grade 304 stainless steel backrests fabricated with a choice mounting options. Con-Serv Backrests feature a 96° inclined, tamper resistant, sanitary safe, UV stabilised HDPE back support and meets the requirements of Section 12.2.4 Backrest of AS 1428.1:2021.

	Code	Finish	Features	
WALL MOUNTED BACKRESTS WITH EXTENSION				
<p>A. Clam® Flange</p> 	CLAM® FLANGE EXTENDED BACKRESTS (A)		<ul style="list-style-type: none"> • WC support device for disabled, aged and the infirmed • Suits single accessible cubicle with either conventional or wall faced pans • 450mm reversible side extension • Polar White UV stabilised HDPE rounded edge back support • Fabricated from 32mm 304 stainless steel • Stainless steel fixing screws supplied • Patent Number 2010101409 • Complies with section 12.2.4 of AS 1428.1:2021 for sanitary facilities   	
		BR 440 BS CF		Brushed Stainless
	BR 440 PS CF	Polish Supreme™		
<p>B. Hygienic Seal®</p>  	HYGIENIC SEAL® EXTENDED BACKRESTS (B)			
		BR 440 BS HS		Brushed Stainless
		BR 440 MB HS		Matte Black
		BR 440 PS HS		Polish Supreme™
		BR 440 WT HS		White
WALL MOUNTED BACKRESTS WITH HIDEAWAY™ MOUNTING SYSTEM				
<p>NEW</p> <p>A.</p> 	HYGIENIC SEAL® BACKRESTS (A)			<ul style="list-style-type: none"> • WC support device for disabled, aged and the infirmed • Hideaway™ End Flanges (4) • Polar White UV stabilised HDPE rounded edge back support • Fabricated from 32mm 304 stainless steel • Stainless steel fixing screws supplied • Patent Number 2010101409 • Complies with section 12.2.4 of AS 1428.1:2021 for sanitary facilities 
		BR 404 MB HS	Matte Black	
	BR 404 PS HS	Polish Supreme™		
<p>B.</p>  	HYGIENIC SEAL® EXTENDED BACKRESTS (B)			
		BR 444 MB HS	Matte Black	
	BR 444 PS HS	Polish Supreme™		
<p>INSTALLED</p> 	<p>HIDEAWAY™</p> 			

All dimensions are in millimetres unless otherwise specified.

Bariatric Collection



Code Finish Features

BARIATRIC STRAIGHT GRAB RAILS

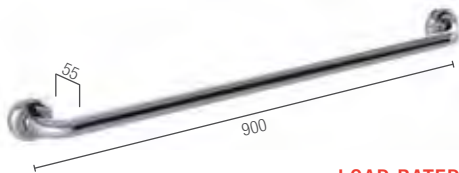
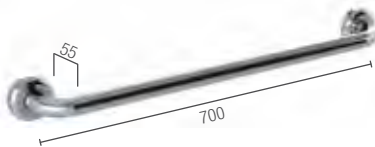
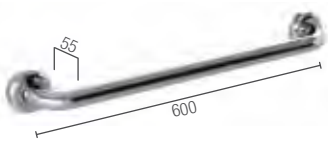
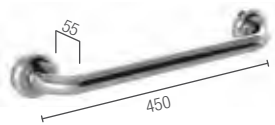
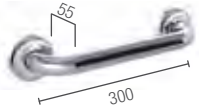

LOAD RATED TO 400KG

300MM	
BG 300 BS	Brushed Stainless
BG 300 PS	Polish Supreme™
450MM	
BG 450 BS	Brushed Stainless
BG 450 PS	Polish Supreme™
600MM	
BG 600 BS	Brushed Stainless
BG 600 PS	Polish Supreme™
700MM	
BG 700 BS	Brushed Stainless
BG 700 PS	Polish Supreme™
900MM	
BG 900 BS	Brushed Stainless
BG 900 PS	Polish Supreme™

- 300mm, 450mm, 600mm, 700mm and 900mm, centre to centre
- 32mm rail fabricated from 304 stainless steel with 3.0mm wall thickness
- 78mm pre-formed domed Clam® Flange
- Wall clearance 55mm
- Stainless steel fixings screws supplied
- Meets the requirements of AS 1428.1:2021 Design for access and mobility
- Tested by QTL to 400kg (test report 203703 9236 - 06/02/2020)



Options available on request

- Welded Toilet Paper Holder (Factory Fitted) - see page 92
- Shower kits - see pages 96-101

BARIATRIC SHOWER RECESS INVERTED "T" GRAB RAILS 700MM X 1100MM

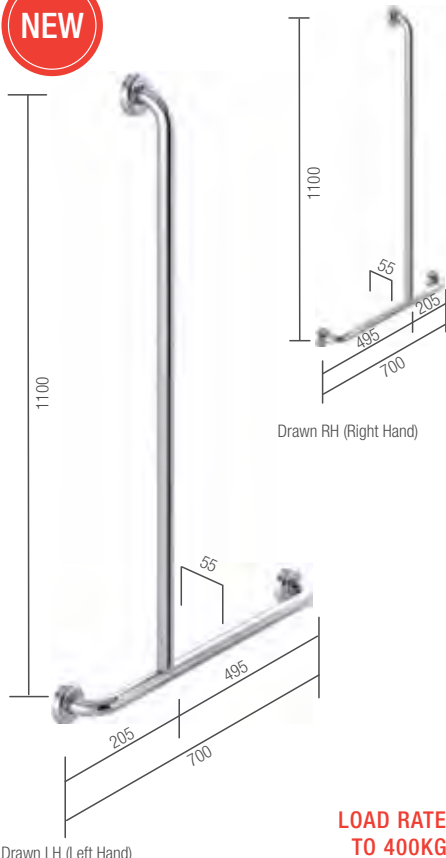

LOAD RATED TO 400KG

BG 071 BS LH	Brushed Stainless
BG 071 BS RH	Brushed Stainless
BG 071 PS LH	Polish Supreme™
BG 071 PS RH	Polish Supreme™





- 700mm x 1100mm, centre to centre
- 32mm rail fabricated from 304 stainless steel with 3.0mm wall thickness
- 78mm pre-formed domed Clam® Flange
- Wall clearance 55mm
- Stainless steel fixings screws supplied
- Meets the requirements of AS 1428.1:2021 Design for access and mobility
- Tested by QTL to 400kg (test report 203703 9236 - 06/02/2020)

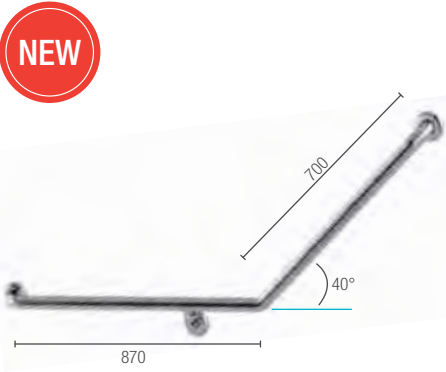

Options available on request

- Shower kits - see pages 96-101

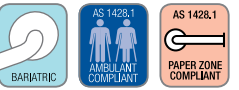
Engineered 32mm grab rails reinforced for bariatric applications. Fabricated from 304 stainless steel with 3.0mm wall thickness, fitted with our 78mm pre-formed domed Clam® Flange. Manufactured to comply with Section 14 of AS 1428.1:2021.

	Code	Finish	Features
BARIATRIC 40° AMBULANT AND ACCESSIBLE GRAB RAILS 870MM x 700MM			
 <p>Drawn LH (Left Hand)</p>	BG 877 BS LH	Brushed Stainless	<ul style="list-style-type: none"> • 870mm x 700mm • 32mm rail fabricated from 304 stainless steel with 3.0mm wall thickness • 78mm pre-formed domed Clam® Flange • Wall clearance 55mm • Stainless steel fixings screws supplied • Meets the requirements of AS 1428.1:2021 Design for access and mobility  <p>Options available on request</p> <ul style="list-style-type: none"> • Welded Toilet Paper Holder (Factory Fitted) - see page 92
	BG 877 BS RH	Brushed Stainless	
	BG 877 PS LH	Polish Supreme™	
	BG 877 PS RH	Polish Supreme™	
BARIATRIC 90° AMBULANT AND ACCESSIBLE GRAB RAILS 450MM x 450MM			
 <p>Drawn LH (Left Hand)</p>	BG 454 BS LH	Brushed Stainless	<ul style="list-style-type: none"> • 450mm x 450mm • 32mm rail fabricated from 304 stainless steel with 3.0mm wall thickness • 78mm pre-formed domed Clam® Flange • Wall clearance 55mm • Stainless steel fixings screws supplied • Meets the requirements of AS 1428.1:2021 Design for access and mobility  <p>Options available on request</p> <ul style="list-style-type: none"> • Welded Toilet Paper Holder (Factory Fitted) - see page 92
	BG 454 BS RH	Brushed Stainless	
	BG 454 PS LH	Polish Supreme™	
	BG 454 PS RH	Polish Supreme™	
BARIATRIC 90° AMBULANT AND ACCESSIBLE GRAB RAILS 960MM x 600MM			
 <p>Drawn LH (Left Hand)</p>	BG 966 BS LH	Brushed Stainless	<ul style="list-style-type: none"> • 870mm x 700mm • 32mm rail fabricated from 304 stainless steel with 3.0mm wall thickness • 78mm pre-formed domed Clam® Flange • Wall clearance 55mm • Stainless steel fixings screws supplied • Meets the requirements of AS 1428.1:2021 Design for access and mobility  <p>Options available on request</p> <ul style="list-style-type: none"> • Welded Toilet Paper Holder (Factory Fitted) - see page 92
	BG 966 BS RH	Brushed Stainless	
	BG 966 PS LH	Polish Supreme™	
	BG 966 PS RH	Polish Supreme™	

Bariatric healthcare showers are made from the highest quality materials and feature dual check facilities as per AS/NZ 3500. Reinforced for bariatric applications, Bariatric showers are fabricated from 304 stainless steel with 3.0mm wall thickness for durable strength and stability.











	Code	Finish	Features
 <p>NEW</p> <p>ABS Glide Slide Cradle</p> <p>LOAD RATED TO 400KG</p>	BG 01809 C	Chrome	<ul style="list-style-type: none"> • 900mm bariatric 32mm grab rail fabricated from 304 stainless steel with 3.0mm wall thickness • Hoscare® handpiece with Biomaster antimicrobial additive • ABS glide slide cradle • Flow Interchange® spigot • Licenced dual check/non-return as per WaterMark AS/NZS 2845.1 WMKA 02696 • 1500mm Silverflex® PVC shower hose • Meets the requirements of AS 1428.1:2021 Design for access and mobility • WaterMark AS/NZS 3662 WMKT 21147 • Available in 3 Star 9L/min and 4 Star 6.5L/min as per WELS licence number 0046 • Tested by QTL to 400kg (test report 203703 9236 - 06/02/2020)     <p>Options available on request</p> <ul style="list-style-type: none"> • HR 015 C - Hose Restrictor Bracket
	BG 01809 C/6.5	Chrome	
	BG 01809 CC	Commercial Chrome	
	BG 01809 CC/6.5	Commercial Chrome	

	Code	Finish	Features	
 <p>NEW</p> <p>ABS Glide Slide Cradle</p> <p>LOAD RATED TO 400KG</p> <p>Drawn LH (Left Hand)</p>	BG 01816 C LH	Chrome	<ul style="list-style-type: none"> • 700mm x 1100mm 32mm grab rail fabricated from 304 stainless steel with 3.0mm wall thickness • Hoscare® handpiece with Biomaster antimicrobial additive • ABS glide slide cradle • Flow Interchange® spigot • Licenced dual check/non-return as per WaterMark AS/NZS 2845.1 WMKA 02696 • 1500mm Silverflex® PVC shower hose • Meets the requirements of AS 1428.1:2021 Design for access and mobility • WaterMark AS/NZS 3662 WMKT 21147 • Available in 3 Star 9L/min and 4 Star 6.5L/min as per WELS licence number 0046 • Tested by QTL to 400kg (test report 203703 9236 - 06/02/2020)     <p>Options available on request</p> <ul style="list-style-type: none"> • HR 015 C - Hose Restrictor Bracket 	
	BG 01816 C LH/6.5	Chrome		
	BG 01816 C RH	Chrome		
	BG 01816 C RH/6.5	Chrome		
	BG 01816 CC LH	Commercial Chrome		
	BG 01816 CC LH/6.5	Commercial Chrome		
	BG 01816 CC RH	Commercial Chrome		
	BG 01816 CC RH/6.5	Commercial Chrome		









BARIATRIC COLLECTION SHOWER SEAT AND TILTLOCK®

Con-Serv's Bariatric Shower Seat and Tiltlock® folding grab rails are designed with additional reinforcement for bariatric applications. Con-Serv Bariatric Shower Seat and Tiltlock® have been tested for a maximum load of 400kg.

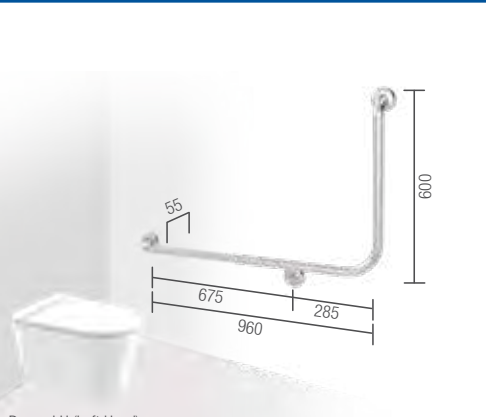
	Code	Finish	Features
BARIATRIC SHOWER SEAT FOR AREAS NOT STRICTLY DISABLED			
 <p>LOAD RATED TO 400KG</p>	SS 965 BS	Brushed Stainless	<ul style="list-style-type: none"> • Seat size: 960mm x 500mm • Additional centre support • Larger seat with self draining channels • Folding legs for added support • Stainless steel fixing screws supplied • Reinforced for bariatric applications, maximum load 400kg <p>Test Report 203780 9349 (29/07/2020)</p> 
BARIATRIC TILTLOCK® 850MM WITH FOLDING LEG			
 <p>Drawn RH (Right Hand)</p> <p>LOAD RATED TO 400KG</p>	TL 850 BS LHBL	Brushed Stainless	<ul style="list-style-type: none"> • 850mm folding grab rail with folding leg • Reinforced for bariatric applications, maximum vertical load 400kg • Fabricated from 32mm 304 stainless steel • Locks in horizontal or vertical positions • Chrome plated brass push-button release, base housing, and concealed "T" mount bracket • Stainless steel fixings supplied • Tested by ANTL (test report 4699.11-12/12/2017) 
		TL 850 BS RHBL	
BARIATRIC FOLDING LEG TILTLOCK® 850MM GRAB RAIL WITH FOLDING LEG & NURSE CALL			
 <p><i>*Nurse call switch not included</i></p> <p>Drawn RH (Right Hand)</p> <p>LOAD RATED TO 400KG</p>	TL 850 BS LHBN*	Brushed Stainless	<ul style="list-style-type: none"> • 850mm folding grab rail with folding leg • Fitted with 304 stainless steel nurse call mount box • Reinforced for bariatric applications, maximum vertical load 400kg • Fabricated from 32mm 304 stainless steel • Locks in horizontal or vertical positions • Chrome plated brass push-button release, base housing, and concealed "T" mount bracket • Stainless steel fixings supplied • Tested by ANTL (test report 4699.11-12/12/2017) 
		TL 850 BS RHBN*	
BARIATRIC TILTLOCK® 850MM GRAB RAIL WITH FOLDING LEG & TOILET PAPER HOLDER			
 <p>Drawn RH (Right Hand)</p> <p>LOAD RATED TO 400KG</p>	TL 850 BS LHBS*	Brushed Stainless	<ul style="list-style-type: none"> • 850mm folding grab rail with folding leg • Fabricated from 32mm 304 stainless steel • Welded stainless steel toilet paper holder • Reinforced for bariatric applications, maximum vertical load 400kg • Locks in horizontal or vertical positions • Chrome plated brass push-button release, base housing, and concealed "T" mount bracket • Stainless steel fixings supplied • Tested by ANTL (test report 4699.11-12/12/2017) 
		TL 850 BS RHBS*	

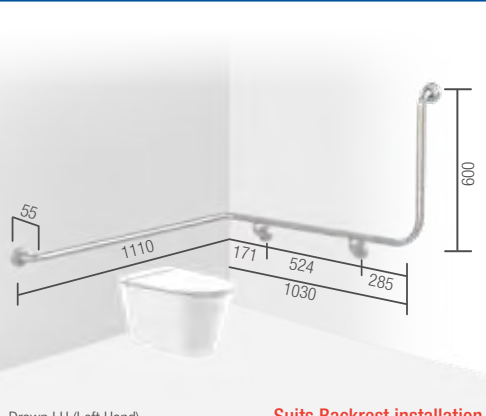

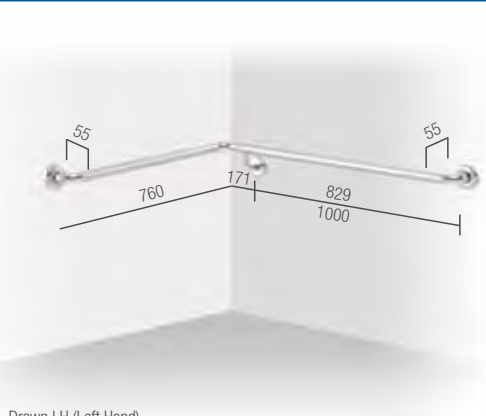
CLAM® FLANGE GRAB RAILS - ACCESSIBLE TOILET ASSIST

Con-Serv's Clam® Flange grab rails are fabricated from 32mm x 1.2mm grade 304, 18/8 stainless steel, and pre-formed 78mm, 5 screw wall mount plate with 360mm rear weld joint. Assembled with 78mm domed Clam® Flange cover with 5° radius to comply with Section 14 of AS 1428.1:2021.

	Code	Finish	Features
CLAM® FLANGE 90° AMBULANT AND ACCESSIBLE GRAB RAILS 450MM x 450MM			
 <p>Reversible, Drawn LH (Left Hand)</p>	CF 454 BS	Brushed Stainless	<ul style="list-style-type: none"> • 450mm x 450mm, centre to centre • 78mm pre-formed domed Clam® Flange • Clam plate is fully welded to 32mm rail for maximum strength • Clam flange cover is a firm press fit to clam plate • Fabricated from 304 stainless steel • Stainless steel fixing screws supplied • Meets the requirements of AS 1428.1:2021 Design for access and mobility  <p>Options available on request</p> <ul style="list-style-type: none"> • Welded Toilet Paper Holder (Factory Fitted) - see page 92 • ABS Flexible Toilet Paper Holder - see page 92
	CF 454 PS	Polish Supreme™	
CLAM® FLANGE 90° AMBULANT AND ACCESSIBLE GRAB RAILS 960MM X 600MM			
 <p>Drawn LH (Left Hand)</p>	CF 966 BS LH	Brushed Stainless	<ul style="list-style-type: none"> • 960mm x 600mm, centre to centre • 78mm pre-formed domed Clam® Flange • Clam plate is fully welded to 32mm rail for maximum strength • Clam flange cover is a firm press fit to clam plate • Fabricated from 304 stainless steel • Stainless steel fixing screws supplied • Meets the requirements of AS 1428.1:2021 Design for access and mobility  <p>Options available on request</p> <ul style="list-style-type: none"> • Welded Toilet Paper Holder (Factory Fitted) - see page 92 • ABS Flexible Toilet Paper Holder - see page 92
	CF 966 BS RH	Brushed Stainless	
	CF 966 PS LH	Polish Supreme™	
	CF 966 PS RH	Polish Supreme™	
CLAM® FLANGE CORNER GRAB RAILS 1110MM X 1030MM X 600MM			
 <p>Drawn LH (Left Hand) Suits Backrest installation</p>	CF 116 BS LH	Brushed Stainless	<ul style="list-style-type: none"> • 1110mm x 1030mm x 600mm, centre to centre • 78mm pre-formed domed Clam® Flange • Clam plate is fully welded to 32mm rail for maximum strength • Clam flange cover is a firm press fit to clam plate • Fabricated from 304 stainless steel • Stainless steel fixing screws supplied • Meets the requirements of AS 1428.1:2021 Design for access and mobility  <p>Options available on request</p> <ul style="list-style-type: none"> • Welded Toilet Paper Holder (Factory Fitted) - see page 92 • ABS Flexible Toilet Paper Holder - see page 92
	CF 116 BS RH	Brushed Stainless	
	CF 116 PS LH	Polish Supreme™	
	CF 116 PS RH	Polish Supreme™	
CLAM® FLANGE CORNER GRAB RAILS 760MM X 1000MM			
 <p>Drawn LH (Left Hand)</p>	CF 761 BS LH	Brushed Stainless	<ul style="list-style-type: none"> • 760mm x 1000mm • 78mm pre-formed domed Clam® Flange • Clam plate is fully welded to 32mm rail for maximum strength • Clam flange cover is a firm press fit to clam plate • Fabricated from 304 stainless steel • Stainless steel fixing screws supplied • Meets the requirements of AS 1428.1:2021 Design for access and mobility  <p>Options available on request</p> <ul style="list-style-type: none"> • Welded Toilet Paper Holder (Factory Fitted) - see page 92 • ABS Flexible Toilet Paper Holder - see page 92
	CF 761 BS RH	Brushed Stainless	
	CF 761 PS LH	Polish Supreme™	
	CF 761 PS RH	Polish Supreme™	

CLAM® FLANGE GRAB RAILS - SHOWER RECESS

Con-Serv's Clam® Flange grab rails are fabricated from 32mm x 1.2mm grade 304, 18/8 stainless steel, and pre-formed 76mm, 5 screw wall mount plate with 360mm rear weld joint. Assembled with 78mm domed Clam® Flange cover with 5° radius to comply with Section 14 of AS 1428.1:2021.

	Code	Finish	Features	
CLAM® FLANGE SHOWER RECESS INVERTED "T" GRAB RAILS 700MM X 1100MM				
<p>Drawn RH (Right Hand)</p>	CF 071 BS LH	Brushed Stainless	<ul style="list-style-type: none"> • 700mm x 1100mm inverted "T" grab rail, centre to centre • 78mm pre-formed domed Clam® Flange • Clam plate is fully welded to 32mm rail for maximum strength • Clam flange cover is a firm press fit to clam plate • Fabricated from 304 stainless steel • Stainless steel fixing screws supplied • Meets the requirements of AS 1428.1:2021 Design for access and mobility   <p>Options available on request</p> <ul style="list-style-type: none"> • ABS Grab Rail Soap Dish Holder - see page 94 • Shower kits - see pages 96-101 	
	CF 071 BS RH	Brushed Stainless		
	CF 071 PS LH	Polish Supreme™		
	CF 071 PS RH	Polish Supreme™		
<p>Drawn LH (Left Hand)</p>				
	CLAM® FLANGE CORNER SHOWER RECESS GRAB RAIL 760MM X 1000MM X 1100MM			
	<p>Drawn RH (Right Hand)</p>	CF 711 BS LH	Brushed Stainless	<ul style="list-style-type: none"> • 760mm x 1000mm x 1100mm • 78mm pre-formed domed Clam® Flange • Clam plate is fully welded to 32mm rail for maximum strength • Clam flange cover is a firm press fit to clam plate • Fabricated from 304 stainless steel • Stainless steel fixing screws supplied • Meets the requirements of AS 1428.1:2021 Design for access and mobility  <p>Options available on request</p> <ul style="list-style-type: none"> • ABS Grab Rail Soap Dish Holder - see page 94 • Shower kits - see pages 96-101
		CF 711 BS RH	Brushed Stainless	
CF 711 PS LH		Polish Supreme™		
CF 711 PS RH		Polish Supreme™		
<p>Drawn LH (Left Hand)</p>				

Clam® Flange healthcare showers are made from the highest quality materials and feature dual check facilities as per AS/NZ 3500. Designed for aged care, hospitals and public facilities, all Con-Serv grab rail showers comply with Section 14 of AS 1428.1:2021 and are WELS rated as per licence number 0046.



	Code	Finish	Features		
CLAM® FLANGE SHOWER KIT 20					
<p>Drawn LH (Left Hand)</p> <p>Friction Slide Cradle</p> <p>Drawn RH (Right Hand)</p>	<p>NEW</p>	CF 01820 C LH	Chrome	<ul style="list-style-type: none"> • 700mm x 1100mm grab rail • 78mm pre-formed domed Clam® Flange • Friction Slide handset cradle • Hoscare® handpiece with Biomaster antimicrobial additive • Chrome plated DR brass wall outlet elbow • Flow Interchange® spigot • Licenced dual check/non-return as per WaterMark AS/NZS 2845.1 WMKA 02696 • 57mm solid brass round flat flange • 1500mm Silverflex PVC shower hose • WaterMark AS/NZS 3662 WMKT 21147 • Available in 3 Star 9L/min and 4 Star 6.5L/min as per WELS licence number 0046 • Meets the requirements of AS 1428.1:2021 Design for access and mobility <p>Options available on request</p> <ul style="list-style-type: none"> • ABS Grab Rail Soap Dish Holder - see page 94 	
		CF 01820 C LH/6.5	Chrome		
		CF 01820 C RH	Chrome		
		CF 01820 C RH/6.5	Chrome		
		CF 01820 CC LH	Commercial Chrome		
		CF 01820 CC LH/6.5	Commercial Chrome		
		CF 01820 CC RH	Commercial Chrome		
		CF 01820 CC RH/6.5	Commercial Chrome		
CLAM® FLANGE SHOWER KIT 16					
<p>Drawn LH (Left Hand)</p> <p>ABS Glide Slide Cradle</p> <p>Drawn RH (Right Hand)</p>	<p>NEW</p>	CF 01816 C LH	Chrome		<ul style="list-style-type: none"> • 700mm x 1100mm grab rail • 78mm pre-formed domed Clam® Flange • ABS Glide Slide handset cradle • Hoscare® handpiece with Biomaster antimicrobial additive • Chrome plated DR brass wall outlet elbow • Flow Interchange® spigot • Licenced dual check/non-return as per WaterMark AS/NZS 2845.1 WMKA 02696 • 57mm solid brass round flat flange • 1500mm Silverflex PVC shower hose • WaterMark AS/NZS 3662 WMKT 21147 • Available in 3 Star 9L/min and 4 Star 6.5L/min as per WELS licence number 0046 • Meets the requirements of AS 1428.1:2021 Design for access and mobility <p>Options available on request</p> <ul style="list-style-type: none"> • ABS Grab Rail Soap Dish Holder - see page 94
		CF 01816 C LH/6.5	Chrome		
		CF 01816 C RH	Chrome		
		CF 01816 C RH/6.5	Chrome		
		CF 01816 CC LH	Commercial Chrome		
		CF 01816 CC LH/6.5	Commercial Chrome		
		CF 01816 CC RH	Commercial Chrome		
		CF 01816 CC RH/6.5	Commercial Chrome		

Hygienic Seal® Collection

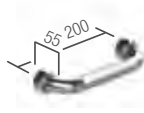
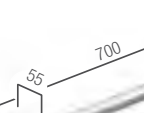

	Code	Finish	Features
HYGIENIC SEAL® STRAIGHT GRAB RAILS 200MM			
	HS 200 AW	Antimicrobial White	<ul style="list-style-type: none"> • 200mm, centre to centre • 32mm grab rail • Fabricated from 304 stainless steel • Assembled with 50mm brass screw on flange covers with Biomaster Thermoplastic Elastomer (TPE) fitted seals • Stainless steel fixing screws supplied • Meets the requirements of AS 1428.1:2021 Design for access and mobility
	HS 200 BS	Brushed Stainless	
	HS 200 MB	Matte Black	
	HS 200 PS	Polish Supreme™	
HYGIENIC SEAL® STRAIGHT GRAB RAILS 300MM			
	HS 300 AW	Antimicrobial White	<ul style="list-style-type: none"> • 300mm, centre to centre • 32mm grab rail • Fabricated from 304 stainless steel • Assembled with 50mm brass screw on flange covers with Biomaster Thermoplastic Elastomer (TPE) fitted seals • Stainless steel fixing screws supplied • Meets the requirements of AS 1428.1:2021 Design for access and mobility
	HS 300 BS	Brushed Stainless	
	HS 300 MB	Matte Black	
	HS 300 PS	Polish Supreme™	
HYGIENIC SEAL® STRAIGHT GRAB RAILS 400MM			
	HS 400 AW	Antimicrobial White	<ul style="list-style-type: none"> • 400mm, centre to centre • 32mm grab rail • Fabricated from 304 stainless steel • Assembled with 50mm brass screw on flange covers with Biomaster Thermoplastic Elastomer (TPE) fitted seals • Stainless steel fixing screws supplied • Meets the requirements of AS 1428.1:2021 Design for access and mobility
	HS 400 BS	Brushed Stainless	
	HS 400 MB	Matte Black	
	HS 400 PS	Polish Supreme™	
HYGIENIC SEAL® STRAIGHT GRAB RAILS 450MM			
	HS 450 AW	Antimicrobial White	<ul style="list-style-type: none"> • 450mm, centre to centre • 32mm grab rail • Fabricated from 304 stainless steel • Assembled with 50mm brass screw on flange covers with Biomaster Thermoplastic Elastomer (TPE) fitted seals • Stainless steel fixing screws supplied • Meets the requirements of AS 1428.1:2021 Design for access and mobility
	HS 450 BS	Brushed Stainless	
	HS 450 MB	Matte Black	
	HS 450 PS	Polish Supreme™	
HYGIENIC SEAL® STRAIGHT GRAB RAILS 500MM			
	HS 500 AW	Antimicrobial White	<ul style="list-style-type: none"> • 500mm, centre to centre • 32mm grab rail • Fabricated from 304 stainless steel • Assembled with 50mm brass screw on flange covers with Biomaster Thermoplastic Elastomer (TPE) fitted seals • Stainless steel fixing screws supplied • Meets the requirements of AS 1428.1:2021 Design for access and mobility
	HS 500 BS	Brushed Stainless	
	HS 500 MB	Matte Black	
	HS 500 PS	Polish Supreme™	
HYGIENIC SEAL® STRAIGHT GRAB RAILS 600MM			
	HS 600 AW	Antimicrobial White	<ul style="list-style-type: none"> • 600mm, centre to centre • 32mm grab rail • Fabricated from 304 stainless steel • Assembled with 50mm brass screw on flange covers with Biomaster Thermoplastic Elastomer (TPE) fitted seals • Stainless steel fixing screws supplied • Meets the requirements of AS 1428.1:2021 Design for access and mobility
	HS 600 BS	Brushed Stainless	
	HS 600 MB	Matte Black	
	HS 600 PS	Polish Supreme™	
HYGIENIC SEAL® STRAIGHT GRAB RAILS 700MM			
	HS 700 AW	Antimicrobial White	<ul style="list-style-type: none"> • 700mm, centre to centre • 32mm grab rail • Fabricated from 304 stainless steel • Assembled with 50mm brass screw on flange covers with Biomaster Thermoplastic Elastomer (TPE) fitted seals • Stainless steel fixing screws supplied • Meets the requirements of AS 1428.1:2021 Design for access and mobility
	HS 700 BS	Brushed Stainless	
	HS 700 MB	Matte Black	
	HS 700 PS	Polish Supreme™	
HYGIENIC SEAL® STRAIGHT GRAB RAILS 750MM			
	HS 750 AW	Antimicrobial White	<ul style="list-style-type: none"> • 750mm, centre to centre • 32mm grab rail • Fabricated from 304 stainless steel • Assembled with 50mm brass screw on flange covers with Biomaster Thermoplastic Elastomer (TPE) fitted seals • Stainless steel fixing screws supplied • Meets the requirements of AS 1428.1:2021 Design for access and mobility
	HS 750 BS	Brushed Stainless	
	HS 750 MB	Matte Black	
	HS 750 PS	Polish Supreme™	

HYGIENIC SEAL® GRAB RAILS - STRAIGHT

Hygienic Seal® premium 32mm grab rails are fabricated from stainless steel with 50mm screw on flange covers featuring Biomaster Thermoplastic Elastomer (TPE) seals. Boasting our smallest flange, Hygienic Seal® grab rails are available in a range of finishes ideal for domestic and commercial environments.



Biomaster antimicrobial seals for added protection against bacteria

	Code	Finish	Features
HYGIENIC SEAL® STRAIGHT GRAB RAILS 800MM			
	HS 800 AW	Antimicrobial White	<ul style="list-style-type: none"> • 800mm, centre to centre • 32mm grab rail • Fabricated from 304 stainless steel • Assembled with 50mm brass screw on flange covers with Biomaster Thermoplastic Elastomer (TPE) fitted seals • Stainless steel fixing screws supplied • Meets the requirements of AS 1428.1:2021 Design for access and mobility
	HS 800 BS	Brushed Stainless	
	HS 800 MB	Matte Black	
	HS 800 PS	Polish Supreme™	
HYGIENIC SEAL® STRAIGHT GRAB RAILS 900MM			
	HS 900 AW	Antimicrobial White	<ul style="list-style-type: none"> • 900mm, centre to centre • 32mm grab rail • Fabricated from 304 stainless steel • Assembled with 50mm brass screw on flange covers with Biomaster Thermoplastic Elastomer (TPE) fitted seals • Stainless steel fixing screws supplied • Meets the requirements of AS 1428.1:2021 Design for access and mobility
	HS 900 BS	Brushed Stainless	
	HS 900 MB	Matte Black	
	HS 900 PS	Polish Supreme™	
HYGIENIC SEAL® STRAIGHT GRAB RAILS 1000MM			
	HS 1000 AW	Antimicrobial White	<ul style="list-style-type: none"> • 1000mm, centre to centre • 32mm grab rail • Fabricated from 304 stainless steel • Assembled with 50mm brass screw on flange covers with Biomaster Thermoplastic Elastomer (TPE) fitted seals • Stainless steel fixing screws supplied • Meets the requirements of AS 1428.1:2021 Design for access and mobility
	HS 1000 BS	Brushed Stainless	
	HS 1000 MB	Matte Black	
	HS 1000 PS	Polish Supreme™	
HYGIENIC SEAL® STRAIGHT GRAB RAILS 1100MM			
	HS 1100 AW	Antimicrobial White	<ul style="list-style-type: none"> • 1100mm, centre to centre • 32mm grab rail • Fabricated from 304 stainless steel • Assembled with 50mm brass screw on flange covers with Biomaster Thermoplastic Elastomer (TPE) fitted seals • Stainless steel fixing screws supplied • Meets the requirements of AS 1428.1:2021 Design for access and mobility
	HS 1100 BS	Brushed Stainless	
	HS 1100 MB	Matte Black	
	HS 1100 PS	Polish Supreme™	
HYGIENIC SEAL® STRAIGHT GRAB RAILS 1200MM			
	HS 1200 AW	Antimicrobial White	<ul style="list-style-type: none"> • 1200mm, centre to centre • 32mm grab rail • Fabricated from 304 stainless steel • Assembled with 50mm brass screw on flange covers with Biomaster Thermoplastic Elastomer (TPE) fitted seals • Stainless steel fixing screws supplied • Meets the requirements of AS 1428.1:2021 Design for access and mobility
	HS 1200 BS	Brushed Stainless	
	HS 1200 MB	Matte Black	
	HS 1200 PS	Polish Supreme™	
HYGIENIC SEAL® STRAIGHT GRAB RAILS 300MM WITH TOILET PAPER HOLDER			
 <p>Drawn RH (Right Hand)</p>	HS 300 AW LHS	Antimicrobial White	<ul style="list-style-type: none"> • 300mm, centre to centre • 32mm grab rail with factory fitted toilet roll holder • Fabricated from 304 stainless steel • Assembled with 50mm brass screw on flange covers with Biomaster Thermoplastic Elastomer (TPE) fitted seals • Stainless steel fixing screws supplied • Meets the requirements of AS 1428.1:2021 Design for access and mobility
	HS 300 AW RHS	Antimicrobial White	
	HS 300 BS LHS	Brushed Stainless	
	HS 300 BS RHS	Brushed Stainless	
	HS 300 MB LHS	Matte Black	
	HS 300 MB RHS	Matte Black	
	HS 300 PS LHS	Polish Supreme™	
	HS 300 PS RHS	Polish Supreme™	
HYGIENIC SEAL® STRAIGHT GRAB RAILS 450MM WITH TOILET PAPER HOLDER			
 <p>Drawn LH (Left Hand)</p>	HS 450 AW LHS	Antimicrobial White	<ul style="list-style-type: none"> • 450mm, centre to centre • 32mm grab rail with factory fitted toilet roll holder • Fabricated from 304 stainless steel • Assembled with 50mm brass screw on flange covers with Biomaster Thermoplastic Elastomer (TPE) fitted seals • Stainless steel fixing screws supplied • Meets the requirements of AS 1428.1:2021 Design for access and mobility
	HS 450 AW RHS	Antimicrobial White	
	HS 450 BS LHS	Brushed Stainless	
	HS 450 BS RHS	Brushed Stainless	
	HS 450 MB LHS	Matte Black	
	HS 450 MB RHS	Matte Black	
	HS 450 PS LHS	Polish Supreme™	
	HS 450 PS RHS	Polish Supreme™	

HYGIENIC SEAL® GRAB RAILS - ACCESSIBLE TOILET ASSIST

Hygienic Seal® premium 32mm grab rails are fabricated from stainless steel with 50mm screw on flange covers featuring Biomaster Thermoplastic Elastomer (TPE) seals. Boasting our smallest flange, Hygienic Seal® grab rails are available in a range of finishes ideal for domestic and commercial environments.



Biomaster antimicrobial seals for added protection against bacteria

	Code	Finish	Features
HYGIENIC SEAL® 40° AMBULANT AND ACCESSIBLE GRAB RAILS 450MM X 450MM			
<p>Drawn LH (Left Hand)</p>	HS 045 AW LH	Antimicrobial White	<ul style="list-style-type: none"> 450mm x 450mm 32mm grab rail fabricated from 304 stainless steel Assembled with 50mm brass screw on flange covers with Biomaster Thermoplastic Elastomer (TPE) fitted seals Stainless steel fixing screws supplied Meets the requirements of AS 1428.1:2021 Design for access and mobility <p>Options available on request</p> <ul style="list-style-type: none"> Welded Toilet Paper Holder (Factory Fitted) - see page 92 ABS Flexible Toilet Paper Holder - see page 92
	HS 045 AW RH	Antimicrobial White	
	HS 045 BS LH	Brushed Stainless	
	HS 045 BS RH	Brushed Stainless	
	HS 045 MB LH	Matte Black	
	HS 045 MB RH	Matte Black	
	HS 045 PS LH	Polish Supreme™	
	HS 045 PS RH	Polish Supreme™	
HYGIENIC SEAL® 40° AMBULANT AND ACCESSIBLE GRAB RAILS 870MM X 700MM			
<p>Drawn LH (Left Hand)</p>	HS 877 AW LH	Antimicrobial White	<ul style="list-style-type: none"> 870mm x 700mm 32mm grab rail fabricated from 304 stainless steel Assembled with 50mm brass screw on flange covers with Biomaster Thermoplastic Elastomer (TPE) fitted seals Stainless steel fixing screws supplied Meets the requirements of AS 1428.1:2021 Design for access and mobility <p>Options available on request</p> <ul style="list-style-type: none"> Welded Toilet Paper Holder (Factory Fitted) - see page 92 ABS Flexible Toilet Paper Holder - see page 92
	HS 877 AW RH	Antimicrobial White	
	HS 877 BS LH	Brushed Stainless	
	HS 877 BS RH	Brushed Stainless	
	HS 877 MB LH	Matte Black	
	HS 877 MB RH	Matte Black	
	HS 877 PS LH	Polish Supreme™	
	HS 877 PS RH	Polish Supreme™	
HYGIENIC SEAL® 90° AMBULANT AND ACCESSIBLE GRAB RAILS 450MM X 450MM			
<p>Drawn LH (Left Hand)</p>	HS 454 AW LH	Antimicrobial White	<ul style="list-style-type: none"> 450mm x 450mm 32mm grab rail fabricated from 304 stainless steel Assembled with 50mm brass screw on flange covers with Biomaster Thermoplastic Elastomer (TPE) fitted seals Stainless steel fixing screws supplied Meets the requirements of AS 1428.1:2021 Design for access and mobility <p>Options available on request</p> <ul style="list-style-type: none"> Welded Toilet Paper Holder (Factory Fitted) - see page 92 ABS Flexible Toilet Paper Holder - see page 92
	HS 454 AW RH	Antimicrobial White	
	HS 454 BS LH	Brushed Stainless	
	HS 454 BS RH	Brushed Stainless	
	HS 454 MB LH	Matte Black	
	HS 454 MB RH	Matte Black	
	HS 454 PS LH	Polish Supreme™	
	HS 454 PS RH	Polish Supreme™	
HYGIENIC SEAL® 90° AMBULANT AND ACCESSIBLE GRAB RAILS 750MM X 750MM			
<p>Reversible Left or Right Hand installation</p>	HS 775 BS	Brushed Stainless	<ul style="list-style-type: none"> 750mm x 750mm, reversible installation 32mm grab rail fabricated from 304 stainless steel Assembled with 50mm brass screw on flange covers with Biomaster Thermoplastic Elastomer (TPE) fitted seals Stainless steel fixing screws supplied Complies with New Zealand standards 4121:2001 <p>Options available on request</p> <ul style="list-style-type: none"> Welded Toilet Paper Holder (Factory Fitted) - see page 92 ABS Flexible Toilet Paper Holder - see page 92
HYGIENIC SEAL® 90° AMBULANT AND ACCESSIBLE GRAB RAILS 960MM X 600MM			
<p>Drawn LH (Left Hand)</p>	HS 966 AW LH	Antimicrobial White	<ul style="list-style-type: none"> 960mm x 600mm 32mm grab rail fabricated from 304 stainless steel Assembled with 50mm brass screw on flange covers with Biomaster Thermoplastic Elastomer (TPE) fitted seals Stainless steel fixing screws supplied Meets the requirements of AS 1428.1:2021 Design for access and mobility <p>Options available on request</p> <ul style="list-style-type: none"> Welded Toilet Paper Holder (Factory Fitted) - see page 92 ABS Flexible Toilet Paper Holder - see page 92
	HS 966 AW RH	Antimicrobial White	
	HS 966 BS LH	Brushed Stainless	
	HS 966 BS RH	Brushed Stainless	
	HS 966 MB LH	Matte Black	
	HS 966 MB RH	Matte Black	
	HS 966 PS LH	Polish Supreme™	
	HS 966 PS RH	Polish Supreme™	



Biomaster antimicrobial seals for added protection against bacteria

HYGIENIC SEAL® GRAB RAILS - ACCESSIBLE TOILET ASSIST & CORNER

Hygienic Seal® premium 32mm grab rails are fabricated from stainless steel with 50mm screw on flange covers featuring Biomaster Thermoplastic Elastomer (TPE) seals. Boasting our smallest flange, Hygienic Seal® grab rails are available in a range of finishes ideal for domestic and commercial environments.

	Code	Finish	Features
HYGIENIC SEAL® 90° AMBULANT AND ACCESSIBLE GRAB RAILS 450MM X 450MM WITH TOILET PAPER HOLDER			
<p>Drawn LH (Left Hand)</p>	HS 454 AW LHS	Antimicrobial White	<ul style="list-style-type: none"> • 450mm x 450mm • 32mm grab rail with factory fitted toilet roll holder • Fabricated from 304 stainless steel • Assembled with 50mm brass screw on flange covers with Biomaster Thermoplastic Elastomer (TPE) fitted seals • Stainless steel fixing screws supplied • Meets the requirements of AS 1428.1:2021 Design for access and mobility
	HS 454 AW RHS	Antimicrobial White	
	HS 454 BS LHS	Brushed Stainless	
	HS 454 BS RHS	Brushed Stainless	
	HS 454 MB LHS	Matte Black	
	HS 454 MB RHS	Matte Black	
	HS 454 PS LHS	Polish Supreme™	
	HS 454 PS RHS	Polish Supreme™	
HYGIENIC SEAL® 90° AMBULANT AND ACCESSIBLE GRAB RAILS 960MM X 600MM WITH TOILET PAPER HOLDER			
<p>Drawn LH (Left Hand)</p>	HS 966 AW LHS	Antimicrobial White	<ul style="list-style-type: none"> • 960mm x 600mm • 32mm grab rail fabricated from 304 stainless steel • Assembled with 50mm brass screw on flange covers with Biomaster Thermoplastic Elastomer (TPE) fitted seals • Stainless steel fixing screws supplied • Meets the requirements of AS 1428.1:2021 Design for access and mobility
	HS 966 AW RHS	Antimicrobial White	
	HS 966 BS LHS	Brushed Stainless	
	HS 966 BS RHS	Brushed Stainless	
	HS 966 MB LHS	Matte Black	
	HS 966 MB RHS	Matte Black	
	HS 966 PS LHS	Polish Supreme™	
	HS 966 PS RHS	Polish Supreme™	
HYGIENIC SEAL® CORNER GRAB RAILS 1110MM X 1030MM X 600MM			
<p>Drawn LH (Left Hand)</p> <p>Suits Backrest installation</p>	HS 116 AW LH	Antimicrobial White	<ul style="list-style-type: none"> • 1110mm x 1030mm x 600mm • 32mm grab rail fabricated from 304 stainless steel • Assembled with 50mm brass screw on flange covers with Biomaster Thermoplastic Elastomer (TPE) fitted seals • Stainless steel fixing screws supplied • Meets the requirements of AS 1428.1:2021 Design for access and mobility <p>Options available on request</p> <ul style="list-style-type: none"> • Welded Toilet Paper Holder (Factory Fitted) - see page 92 • ABS Flexible Toilet Paper Holder - see page 92
	HS 116 AW RH	Antimicrobial White	
	HS 116 BS LH	Brushed Stainless	
	HS 116 BS RH	Brushed Stainless	
	HS 116 MB LH	Matte Black	
	HS 116 MB RH	Matte Black	
	HS 116 PS LH	Polish Supreme™	
	HS 116 PS RH	Polish Supreme™	
HYGIENIC SEAL® CORNER GRAB RAILS 800MM X 800MM			
<p>Drawn LH (Left Hand)</p> <p>Made to order. NON-RETURNABLE</p>	HS 880 AW LH	Antimicrobial White	<ul style="list-style-type: none"> • 800mm x 800mm • 32mm grab rail fabricated from 304 stainless steel • Assembled with 50mm brass screw on flange covers with Biomaster Thermoplastic Elastomer (TPE) fitted seals • Stainless steel fixing screws supplied • Meets the requirements of AS 1428.1:2021 Design for access and mobility <p>Options available on request</p> <ul style="list-style-type: none"> • Welded Toilet Paper Holder (Factory Fitted) - see page 92 • ABS Flexible Toilet Paper Holder - see page 92
	HS 880 AW RH	Antimicrobial White	
	HS 880 BS LH	Brushed Stainless	
	HS 880 BS RH	Brushed Stainless	
	HS 880 MB LH	Matte Black	
	HS 880 MB RH	Matte Black	
	HS 880 PS LH	Polish Supreme™	
	HS 880 PS RH	Polish Supreme™	
HYGIENIC SEAL® CORNER GRAB RAILS 760MM X 1000MM			
<p>Drawn LH (Left Hand)</p>	HS 761 AW LH	Antimicrobial White	<ul style="list-style-type: none"> • 760mm x 1000mm • 32mm grab rail fabricated from 304 stainless steel • Assembled with 50mm brass screw on flange covers with Biomaster Thermoplastic Elastomer (TPE) fitted seals • Stainless steel fixing screws supplied • Meets the requirements of AS 1428.1:2021 Design for access and mobility <p>Options available on request</p> <ul style="list-style-type: none"> • Welded Toilet Paper Holder (Factory Fitted) - see page 92 • ABS Flexible Toilet Paper Holder - see page 92
	HS 761 AW RH	Antimicrobial White	
	HS 761 BS LH	Brushed Stainless	
	HS 761 BS RH	Brushed Stainless	
	HS 761 MB LH	Matte Black	
	HS 761 MB RH	Matte Black	
	HS 761 PS LH	Polish Supreme™	
	HS 761 PS RH	Polish Supreme™	

All dimensions are in millimetres unless otherwise specified.

HYGIENIC SEAL® GRAB RAILS - SHOWER RECESS

Hygienic Seal® premium 32mm grab rails are fabricated from stainless steel with 50mm screw on flange covers featuring Biomaster Thermoplastic Elastomer (TPE) seals. Boasting our smallest flange, Hygienic Seal® grab rails are available in a range of finishes ideal for domestic and commercial environments.



Biomaster antimicrobial seals for added protection against bacteria

Code Finish Features

HYGIENIC SEAL® SHOWER RECESS INVERTED "T" GRAB RAILS 700MM X 1100MM

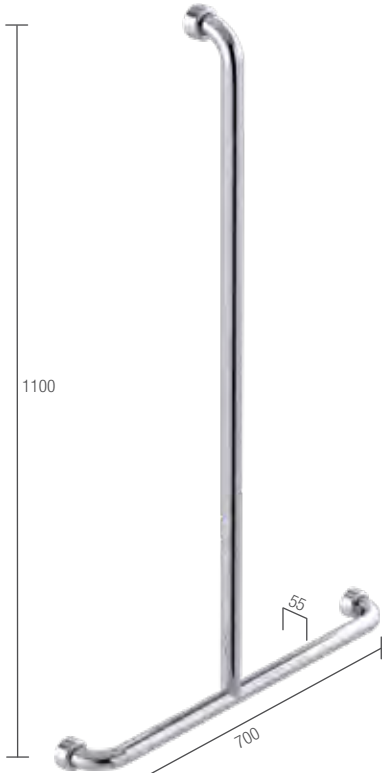

Drawn MF (Middle Fixed)

Only left and right hand positions meet the requirements of AS 1428.1:2021

Code	Finish
HS 071 AW LH	Antimicrobial White
HS 071 AW MF	Antimicrobial White
HS 071 AW RH	Antimicrobial White
HS 071 BS LH	Brushed Stainless
HS 071 BS MF	Brushed Stainless
HS 071 BS RH	Brushed Stainless
HS 071 MB LH	Matte Black
HS 071 MBMF	Matte Black
HS 071 MB RH	Matte Black
HS 071 PS LH	Polish Supreme™
HS 071 PS MF	Polish Supreme™
HS 071 PS RH	Polish Supreme™

- 700mm x 1100mm inverted "T" grab rail
- 32mm grab rail fabricated from 304 stainless steel
- Assembled with 50mm brass screw on flange covers with Biomaster Thermoplastic Elastomer (TPE) fitted seals
- Stainless steel fixing screws supplied
- Available in Left Hand, Middle Fixed or Right Hand orientations
- Left and right hand models meet the requirements of AS 1428.1:2021 Design for access and mobility



Options available on request

- ABS Grab Rail Soap Dish Holder - see page 94
- Shower kits - see pages 96-101

HYGIENIC SEAL® CORNER SHOWER RECESS GRAB RAILS 760MM X 1000MM X 1100MM

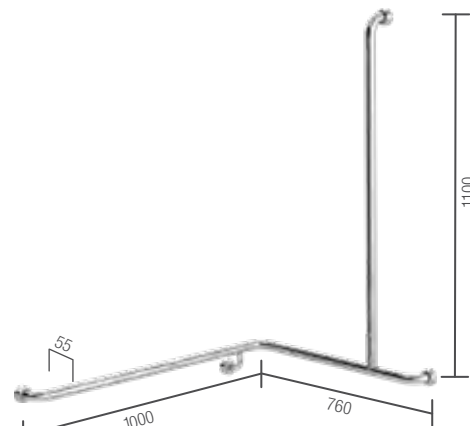

Drawn RH (Right Hand)

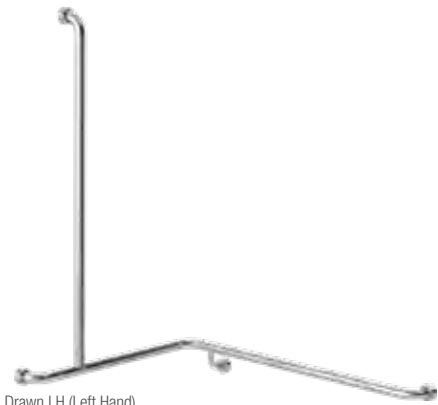

Drawn LH (Left Hand)

Code	Finish
HS 711 AW LH	Antimicrobial White
HS 711 AW RH	Antimicrobial White
HS 711 BS LH	Brushed Stainless
HS 711 BS RH	Brushed Stainless
HS 711 MB LH	Matte Black
HS 711 MB RH	Matte Black
HS 711 PS LH	Polish Supreme™
HS 711 PS RH	Polish Supreme™

- 760mm x 1000mm x 1100mm grab rail
- 32mm grab rail fabricated from 304 stainless steel
- Assembled with 50mm brass screw on flange covers with Biomaster Thermoplastic Elastomer (TPE) fitted seals
- Stainless steel fixing screws supplied
- Meets the requirements of AS 1428.1:2021 Design for access and mobility



Options available on request

- ABS Grab Rail Soap Dish Holder - see page 94
- Shower kits - see pages 96-101

HYGIENIC SEAL® GRAB RAILS - TOWEL GRAB RAILS

Hygienic Seal® premium 32mm grab rails are fabricated from stainless steel with 50mm screw on flange covers featuring Biomaster Thermoplastic Elastomer (TPE) seals. Boasting our smallest flange, Hygienic Seal® grab rails are available in a range of finishes ideal for domestic and commercial environments.





Biomaster antimicrobial seals for added protection against bacteria



	Code	Finish	Features
HYGIENIC SEAL® TOWEL GRAB RAILS 600MM "D" SHAPE			
	HT 600 AW D	Antimicrobial White	<ul style="list-style-type: none"> • 600mm "D" shape, centre to centre • 32mm grab rail fabricated from 304 stainless steel • Assembled with 50mm brass screw on flange covers with Biomaster Thermoplastic Elastomer (TPE) fitted seals • Stainless steel fixing screws supplied
	HT 600 BS D	Brushed Stainless	
	HT 600 MB D	Matt Black	
	HT 600 PS D	Polish Supreme™	
HYGIENIC SEAL® TOWEL GRAB RAILS 800MM "D" SHAPE			
	HT 800 AW D	Antimicrobial White	<ul style="list-style-type: none"> • 800mm "D" shape, centre to centre • 32mm grab rail fabricated from 304 stainless steel • Assembled with 50mm brass screw on flange covers with Biomaster Thermoplastic Elastomer (TPE) fitted seals • Stainless steel fixing screws supplied
	HT 800 BS D	Brushed Stainless	
	HT 800 MB D	Matt Black	
	HT 800 PS D	Polish Supreme™	
HYGIENIC SEAL® TOWEL GRAB RAILS 600MM "U" SHAPE			
	HT 600 AW U	Antimicrobial White	<ul style="list-style-type: none"> • 600mm "U" shape, centre to centre • 32mm grab rail fabricated from 304 stainless steel • Assembled with 50mm brass screw on flange covers with Biomaster Thermoplastic Elastomer (TPE) fitted seals • Stainless steel fixing screws supplied • Meets the requirements of AS 1428.1:2021 Design for access and mobility
	HT 600 BS U	Brushed Stainless	
	HT 600 MB U	Matt Black	
	HT 600 PS U	Polish Supreme™	
HYGIENIC SEAL® TOWEL GRAB RAILS 800MM "U" SHAPE			
	HT 800 AW U	Antimicrobial White	<ul style="list-style-type: none"> • 800mm "U" shape, centre to centre • 32mm grab rail fabricated from 304 stainless steel • Assembled with 50mm brass screw on flange covers with Biomaster Thermoplastic Elastomer (TPE) fitted seals • Stainless steel fixing screws supplied • Meets the requirements of AS 1428.1:2021 Design for access and mobility
	HT 800 BS U	Brushed Stainless	
	HT 800 MB U	Matt Black	
	HT 800 PS U	Polish Supreme™	



HYGIENIC SEAL® - GLIDE SLIDE 900MM



- 900mm grab rail
- Hygienic Seal® flange with antimicrobial seals
- Meets requirements of AS 1428.1:2021
- DR brass wall outlet elbow
- ABS Glide Slide Cradle
- ABS handpiece with rub-clean diffuser
- PVC 1500mm Silverflex™ hose
- Licenced dual check/non-return valve
- Brass 57mm wall flange
- Stainless steel fixings supplied



Model Code Finish Features



STREAMJET™			
	GS 900J C	Chrome	<ul style="list-style-type: none"> • ABS 100mm single function shower • Concentric full pattern spray • Rub-clean spray diffuser • WaterMark AS 3662 WMKT 21147 • Available in 3 Star 9L/min and 4 Star 6.5L/min as per WELS licence number 0046 
	GS 900J C/6.5	Chrome	
	GS 900J WTC	White/Chrome	
	GS 900J WTC/6.5	White/Chrome	

STREAMJET™ TURBO PULSATOR			
	GS 900T C	Chrome	<ul style="list-style-type: none"> • ABS 100mm multi-function shower • Soft, pulsating and bubble spray functions • Rub-clean spray diffuser • WaterMark AS 3662 WMKT 21147 • Available in 3 Star 9L/min as per WELS licence number 0046 

STREAMJET™ XL			
	GS 900X C	Chrome	<ul style="list-style-type: none"> • ABS 130mm single function shower • Concentric full pattern spray • Rub-clean spray diffuser • WaterMark AS 3662 WMKT 21147 • Available in 3 Star 9L/min as per WELS licence number 0046 

STREAMJET™ XL TURBO PULSATOR			
	GS 900S C	Chrome	<ul style="list-style-type: none"> • ABS 130mm multi-function shower • Soft, pulsating and bubble spray functions • Rub-clean spray diffuser • WaterMark AS 3662 WMKT 21147 • Available in 3 Star 9L/min as per WELS licence number 0046 

PRINCESS			
	GS 900P C	Chrome	<ul style="list-style-type: none"> • ABS 83mm arched single function shower • Full pattern spray • Rub-clean spray diffuser • WaterMark AS 3662 WMKT 21147 • Available in 3 Star 9L/min as per WELS licence number 0046 

BREEZE			
	GS 900Z C	Chrome	<ul style="list-style-type: none"> • ABS 104mm arched multi-function shower • Soft, pulsating and bubble spray functions • Rub-clean spray diffuser • Available in 3 Star 9L/min as per WELS licence number 0046 

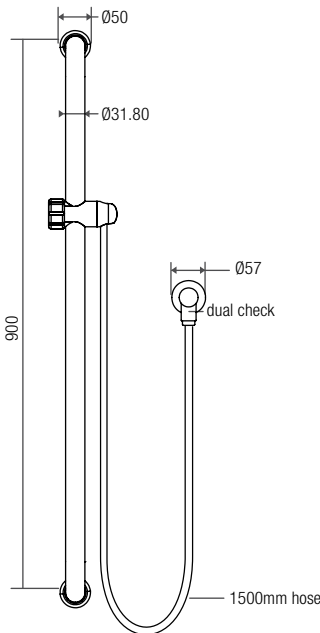

Model shown: GS 900X C

HYGIENIC SEAL® - GLIDE SLIDE 700MM x 1100MM

- 700mm x 1100mm grab rail
- Hygienic Seal® flange with antimicrobial seals
- Licenced dual check/non-return valve
- DR brass wall outlet elbow
- ABS Glide Slide Cradle
- ABS handpiece with rub-clean diffuser
- PVC 1500mm Silverflex™ hose
- Brass 57mm wall flange
- Stainless steel fixings supplied



ABS Glide Slide Cradle

Drawn MF (Middle Fix)

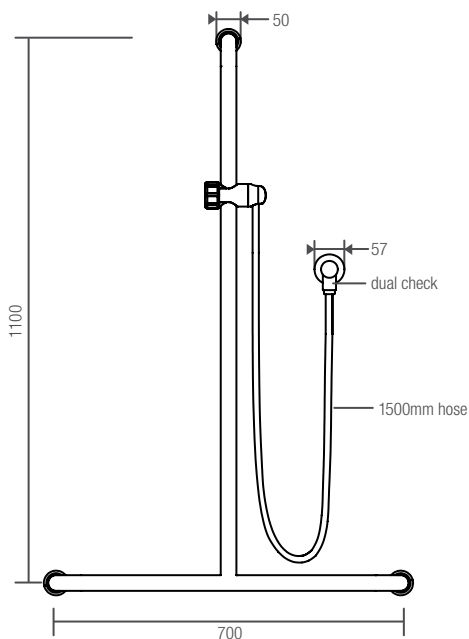

Model	Code	Finish	Features
STREAMJET™			
	GS 071J C LH	Chrome	<ul style="list-style-type: none"> • ABS 100mm single function shower • Concentric full pattern spray • Rub-clean spray diffuser • WaterMark AS 3662 WMKT 21147 • Available in 3 Star 9L/min and 4 Star 6.5L/min as per WELS licence number 0046
	GS 071J C MF	Chrome	
	GS 071J C RH	Chrome	
	GS 071J C LH/6.5	Chrome	
	GS 071J C MF/6.5	Chrome	
	GS 071J C RH/6.5	Chrome	
	GS 071J WTC LH	White/Chrome	
	GS 071J WTC MF	White/Chrome	
	GS 071J WTC RH	White/Chrome	
	GS 071J WTC LH/6.5	White/Chrome	
	GS 071J WTC MF/6.5	White/Chrome	
GS 071J WTC RH/6.5	White/Chrome		
STREAMJET™ TURBO PULSATOR			
	GS 071T C LH	Chrome	<ul style="list-style-type: none"> • ABS 100mm multi-function shower • Soft, pulsating and bubble spray • Rub-clean spray diffuser • WaterMark AS 3662 WMKT 21147 • Available in 3 Star 9L/min as per WELS licence number 0046
	GS 071T C MF	Chrome	
	GS 071T C RH	Chrome	
STREAMJET™ XL			
	GS 071X C LH	Chrome	<ul style="list-style-type: none"> • ABS 130mm single function shower • Concentric full pattern spray • Rub-clean spray diffuser • WaterMark AS 3662 WMKT 21147 • Available in 3 Star 9L/min as per WELS licence number 0046
	GS 071X C MF	Chrome	
	GS 071X C RH	Chrome	
STREAMJET™ XL TURBO PULSATOR			
	GS 071S C LH	Chrome	<ul style="list-style-type: none"> • ABS 130mm multi-function shower • Soft, pulsating and bubble spray • Rub-clean spray diffuser • WaterMark AS 3662 WMKT 21147 • Available in 3 Star 9L/min as per WELS licence number 0046
	GS 071S C MF	Chrome	
	GS 071S C RH	Chrome	
PRINCESS			
	GS 071P C LH	Chrome	<ul style="list-style-type: none"> • ABS 83mm arched single function • Full pattern spray • Rub-clean spray diffuser • WaterMark AS 3662 WMKT 21147 • Available in 3 Star 9L/min as per WELS licence number 0046
	GS 071P C MF	Chrome	
	GS 071P C RH	Chrome	
BREEZE			
	GS 071Z C LH	Chrome	<ul style="list-style-type: none"> • ABS 104mm arched multi-function shower • Soft, pulsating and bubble spray • Rub-clean spray diffuser • Available in 3 Star 9L/min as per WELS licence number 0046
	GS 071Z C MF	Chrome	
	GS 071Z C RH	Chrome	







Model shown: GS 071T C MF



HYGIENIC SEAL® - FRICTION SLIDE 900MM



- 900mm grab rail
- Hygienic Seal® flange with antimicrobial seals
- Meets requirements of AS 1428.1:2021
- DR brass wall outlet elbow
- Brass Friction Slide Cradle
- ABS handpiece with rub-clean diffuser
- PVC 1500mm Silverflex™ hose
- Licenced dual check/non-return valve
- Brass 57mm wall flange
- Stainless steel fixings supplied



Model Code Finish Features



STREAMJET™			
	HF 900J BN	Brushed Nickel	<ul style="list-style-type: none"> • ABS 100mm single function shower • Concentric full pattern spray • Rub-clean spray diffuser • WaterMark AS 3662 WMKT 21147 • Available in 3 Star 9L/min and 4 Star 6.5L/min as per WELS licence number 0046 
	HF 900J BN/6.5	Brushed Nickel	
	HF 900J C	Chrome	
	HF 900J C/6.5	Chrome	
	HF 900J MB	Matte Black	
	HF 900J MB/6.5	Matte Black	

STREAMJET™ TURBO PULSATOR				
	HF 900T C	Chrome	<ul style="list-style-type: none"> • ABS 100mm multi-function shower • Soft, pulsating and bubble spray functions • Rub-clean spray diffuser • WaterMark AS 3662 WMKT 21147 • Available in 3 Star 9L/min as per WELS licence number 0046 	

STREAMJET™ XL			
	HF 900X BN	Brushed Nickel	<ul style="list-style-type: none"> • ABS 130mm single function shower • Concentric full pattern spray • Rub-clean spray diffuser • WaterMark AS 3662 WMKT 21147 • Available in 3 Star 9L/min as per WELS licence number 0046 
	HF 900X C	Chrome	
	HF 900X MB	Matte Black	

STREAMJET™ XL TURBO PULSATOR				
	HF 900S C	Chrome	<ul style="list-style-type: none"> • ABS 130mm multi-function shower • Soft, pulsating and bubble spray functions • Rub-clean spray diffuser • WaterMark AS 3662 WMKT 21147 • Available in 3 Star 9L/min as per WELS licence number 0046 	

PRINCESS				
	HF 900P C	Chrome	<ul style="list-style-type: none"> • ABS 83mm arched single function shower • Full pattern spray • Rub-clean spray diffuser • WaterMark AS 3662 WMKT 21147 • Available in 3 Star 9L/min as per WELS licence number 0046 	

BREEZE				
	HF 900Z C	Chrome	<ul style="list-style-type: none"> • ABS 104mm arched multi-function shower • Soft, pulsating and bubble spray functions • Rub-clean spray diffuser • Available in 3 Star 9L/min as per WELS licence number 0046 	

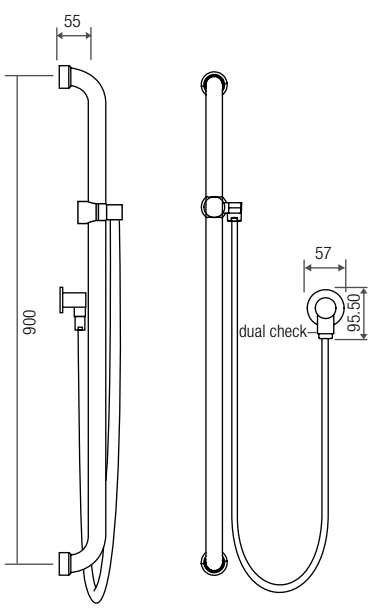

Model shown: HF 900J C

HYGIENIC SEAL® SHOWER KITS

HYGIENIC SEAL® - FRICTION SLIDE 700MM x 1100MM

- 700mm x 1100mm grab rail
- Hygienic Seal® flange with antimicrobial seals
- Licenced dual check/non-return valve
- DR brass wall outlet elbow
- Brass Friction Slide Cradle
- ABS handpiece with rub-clean diffuser
- PVC 1500mm Silverflex™ hose
- Brass 57mm wall flange
- Stainless steel fixings supplied

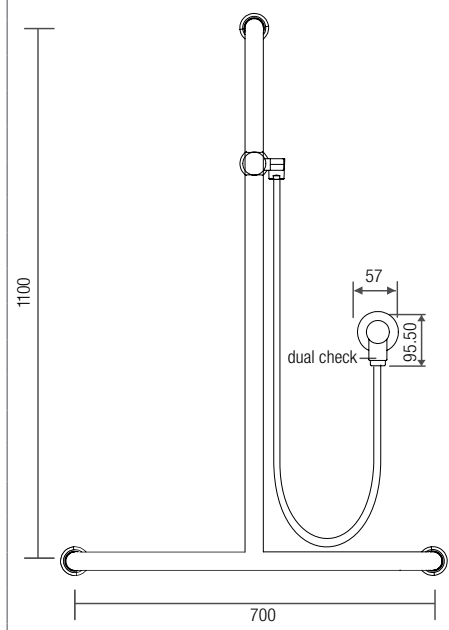

Model	Code	Finish	Features
-------	------	--------	----------

STREAMJET™			
	HF 071J BN LH	Brushed Nickel	<ul style="list-style-type: none"> • ABS 100mm single function shower • Concentric full pattern spray • Rub-clean spray diffuser • WaterMark AS 3662 WMKT 21147 • Available in 3 Star 9L/min and 4 Star 6.5L/min as per WELS licence number 0046
	HF 071J BN MF	Brushed Nickel	
	HF 071J BN RH	Brushed Nickel	
	HF 071J BN LH/6.5	Brushed Nickel	
	HF 071J BN MF/6.5	Brushed Nickel	
	HF 071J BN RH/6.5	Brushed Nickel	
	HF 071J C LH	Chrome	
	HF 071J C MF	Chrome	
	HF 071J C RH	Chrome	
	HF 071J C LH/6.5	Chrome	
	HF 071J C MF/6.5	Chrome	
	HF 071J C RH/6.5	Chrome	
	HF 071J MB LH	Matte Black	
	HF 071J MB MF	Matte Black	
	HF 071J MB RH	Matte Black	
	HF 071J MB LH/6.5	Matte Black	
HF 071J MB MF/6.5	Matte Black		
HF 071J MB RH/6.5	Matte Black		

STREAMJET™ TURBO PULSATOR			
	HF 071T C LH	Chrome	<ul style="list-style-type: none"> • ABS 100mm multi-function shower • Soft, pulsating and bubble spray • Rub-clean spray diffuser • WaterMark AS 3662 WMKT 21147 • Available in 3 Star 9L/min as per WELS licence number 0046
	HF 071T C MF	Chrome	
	HF 071T C RH	Chrome	

STREAMJET™ XL			
	HF 071X BN LH	Brushed Nickel	<ul style="list-style-type: none"> • ABS 130mm single function shower • Concentric full pattern spray • Rub-clean spray diffuser • WaterMark AS 3662 WMKT 21147 • Available in 3 Star 9L/min as per WELS licence number 0046
	HF 071X BN MF	Brushed Nickel	
	HF 071X BN RH	Brushed Nickel	
	HF 071X C LH	Chrome	
	HF 071X C MF	Chrome	
	HF 071X C RH	Chrome	
	HF 071X MB LH	Matte Black	
	HF 071X MB MF	Matte Black	
	HF 071X MB RH	Matte Black	

STREAMJET™ XL TURBO PULSATOR			
	HF 071S C LH	Chrome	<ul style="list-style-type: none"> • ABS 130mm multi-function shower • Soft, pulsating and bubble spray • Rub-clean spray diffuser • WaterMark AS 3662 WMKT 21147 • Available in 3 Star 9L/min as per WELS licence number 0046
	HF 071S C MF	Chrome	
	HF 071S C RH	Chrome	

PRINCESS			
	HF 071P C LH	Chrome	<ul style="list-style-type: none"> • ABS 83mm arched single function • Full pattern spray • Rub-clean spray diffuser • WaterMark AS 3662 WMKT 21147 • Available in 3 Star 9L/min as per WELS licence number 0046
	HF 071P C MF	Chrome	
	HF 071P C RH	Chrome	

BREEZE			
	HF 071Z C LH	Chrome	<ul style="list-style-type: none"> • ABS 104mm arched multi-function shower • Soft, pulsating and bubble spray • Rub-clean spray diffuser • Available in 3 Star 9L/min as per WELS licence number 0046
	HF 071Z C MF	Chrome	
	HF 071Z C RH	Chrome	



Model shown: HF 071T C MF

Independent accessible showers provide ease of access and adjustment for seated users as specified in AS 1428.1:2021, combined with Hygienic Seal® superior grab rails. Made from the highest quality tested materials, Hygienic Seal® accessible showers provide hospitals and aged care facilities with reliable function, practical safety, water efficiency and dual check/non-return as per AS/NZ 3500.



AS 1428.1:2021 Shower Head

An adjustable shower head holder shall be provided to support the shower head and shall allow the graspable portion of the shower head to be positioned at various angles and heights and also allow the graspable portion of the shower head to be located at heights between 1000mm and 1800mm above the plane of the finished floor and allow access and adjustment from a seated position.

The above clause only applies to accessible bathrooms in public buildings, factories, hotels, motels and designated bathrooms in hospitals, homes for the elderly and nursing homes.

Code Finish Features

HYGIENIC SEAL® ACCESSIBLE KIT 3



WITH 1500MM SHOWER HOSE

ID 01803 C	Chrome
ID 01803 C/6.5	Chrome
ID 01803 CC	Commercial Chrome
ID 01803 CC/6.5	Commercial Chrome

WITH 2000MM SHOWER HOSE

ID 01803 C2	Chrome
ID 01803 C2/6.5	Chrome
ID 01803 CC2	Commercial Chrome
ID 01803 CC2/6.5	Commercial Chrome

- 1000mm grab rail, centre to centre
- 50mm Hygienic Seal® with Biomaster antimicrobial additive
- Friction Slide handset cradle
- Push-PullMe® shower height adjustment rod
- Hoscare® handpiece with Biomaster antimicrobial additive
- Chrome plated DR brass wall outlet elbow
- Flow Interchange® spigot
- Licenced dual check/non-return as per WaterMark AS/NZS 2845.1 WMKA 02696
- 57mm solid brass round flat flange
- Silverflex PVC shower hose
- WaterMark AS/NZS 3662 WMKT 21147
- Available in 3 Star 9L/min and 4 Star 6.5L/min as per WELS licence number 0046
- Meets the requirements of AS 1428.1:2021 Design for access and mobility



Options available on request

- ABS Grab Rail Soap Dish Holder - see page 94

HYGIENIC SEAL® ACCESSIBLE KIT 20

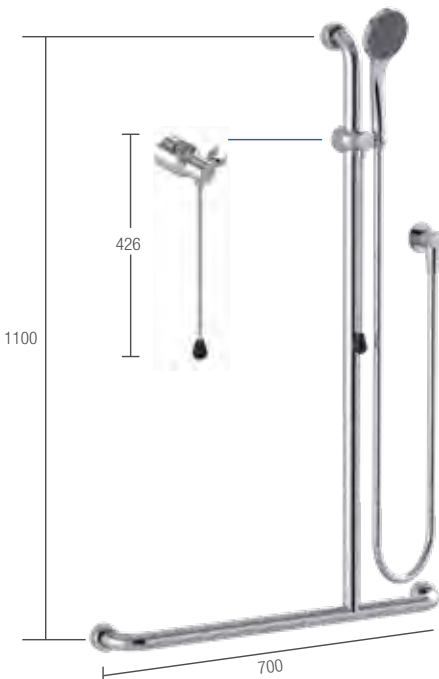

WITH 1500MM SHOWER HOSE

ID 01820 C LH	Chrome
ID 01820 C RH	Chrome
ID 01820 C LH/6.5	Chrome
ID 01820 C RH/6.5	Chrome

ID 01820 CC LH	Commercial Chrome
ID 01820 CC RH	Commercial Chrome
ID 01820 CC LH/6.5	Commercial Chrome
ID 01820 CC RH/6.5	Commercial Chrome

WITH 2000MM SHOWER HOSE

ID 01820 C2 LH	Chrome
ID 01820 C2 RH	Chrome
ID 01820 C2 LH/6.5	Chrome
ID 01820 C2 RH/6.5	Chrome

ID 01820 CC2 LH	Commercial Chrome
ID 01820 CC2 RH	Commercial Chrome
ID 01820 CC2 LH/6.5	Commercial Chrome
ID 01820 CC2 RH/6.5	Commercial Chrome

- 700mm x 1100mm grab rail, centre to centre
- 32mm grab rail fabricated from 304 stainless steel
- 50mm Hygienic Seal® with Biomaster antimicrobial additive
- Friction Slide handset cradle
- Push-PullMe® shower height adjustment rod
- Hoscare® handpiece with Biomaster antimicrobial additive care
- Chrome plated DR brass wall outlet elbow
- Flow Interchange® spigot
- Licenced dual check/non-return as per WaterMark AS/NZS 2845.1 WMKA 02696
- 57mm solid brass round flat flange
- Silverflex PVC shower hose
- WaterMark AS/NZS 3662 WMKT 21147
- Available in 3 Star 9L/min and 4 Star 6.5L/min as per WELS licence number 0046
- Meets the requirements of AS 1428.1:2021 Design for access and mobility









Options available on request

- ABS Grab Rail Soap Dish Holder - see page 94

HYGIENIC SEAL® COMMERCIAL SHOWER KITS

Hygienic Seal® healthcare showers are made from quality materials and feature dual check facilities as per AS/NZ 3500. All kits include Hygienic Seal® 32mm grab rails assembled with 50mm flange covers featuring Biomaster Thermoplastic Elastomer (TPE) seals, and are WELS rated as per licence number 0046.

	Code	Finish	Features		
HYGIENIC SEAL® SHOWER KIT 3					
  <p>Friction Slide Cradle</p>	WITH 1500MM SHOWER HOSE		<ul style="list-style-type: none"> • 900mm grab rail, centre to centre • 50mm Hygienic Seal® with Biomaster antimicrobial additive • Friction Slide handset cradle • Hoscare® handpiece with Biomaster antimicrobial additive • Chrome plated DR brass wall outlet elbow • Flow Interchange® spigot • Licenced dual check/non-return as per WaterMark AS/NZS 2845.1 WMKA 02696 • 57mm solid brass round flat flange • Silverflex PVC shower hose • WaterMark AS/NZS 3662 WMKT 21147 • Available in 3 Star 9L/min and 4 Star 6.5L/min as per WELS licence number 0046 • Meets the requirements of AS 1428.1:2021 Design for access and mobility    <p>Options available on request</p> <ul style="list-style-type: none"> • ABS Grab Rail Soap Dish Holder - see page 94 		
	HS 01803 C	Chrome			
	HS 01803 C/6.5	Chrome			
	HS 01803 CC	Commercial Chrome			
	HS 01803 CC/6.5	Commercial Chrome			
	WITH 2000MM SHOWER HOSE				
	HS 01803 C2	Chrome			
	HS 01803 C2/6.5	Chrome			
	HS 01803 CC2	Commercial Chrome			
	HS 01803 CC2/6.5	Commercial Chrome			
	HYGIENIC SEAL® SHOWER KIT 9				
	  <p>ABS Glide Slide Cradle</p>	WITH 1500MM SHOWER HOSE		<ul style="list-style-type: none"> • 900mm grab rail, centre to centre • 50mm Hygienic Seal® with Biomaster antimicrobial additive • ABS Glide Slide handset cradle • Hoscare® handpiece with Biomaster antimicrobial additive • Chrome plated DR brass wall outlet elbow • Flow Interchange® spigot • Licenced dual check/non-return as per WaterMark AS/NZS 2845.1 WMKA 02696 • 57mm solid brass round flat flange • Silverflex PVC shower hose • WaterMark AS/NZS 3662 WMKT 21147 • Available in 3 Star 9L/min and 4 Star 6.5L/min as per WELS licence number 0046 • Meets the requirements of AS 1428.1:2021 Design for access and mobility    <p>Options available on request</p> <ul style="list-style-type: none"> • ABS Grab Rail Soap Dish Holder - see page 94 	
		HS 01809 C			Chrome
		HS 01809 C/6.5			Chrome
HS 01809 CC		Commercial Chrome			
HS 01809 CC/6.5		Commercial Chrome			
WITH 2000MM SHOWER HOSE					
HS 01809 C2		Chrome			
HS 01809 C2/6.5		Chrome			
HS 01809 CC2		Commercial Chrome			
HS 01809 CC2/6.5		Commercial Chrome			

HYGIENIC SEAL® COMMERCIAL SHOWER KITS

Hygienic Seal® healthcare showers are made from quality materials and feature dual check facilities as per AS/NZ 3500. All kits include Hygienic Seal® 32mm grab rails assembled with 50mm flange covers featuring Biomaster Thermoplastic Elastomer (TPE) seals, and are WELS rated as per licence number 0046.



Code Finish Features

HYGIENIC SEAL® SHOWER KIT 5

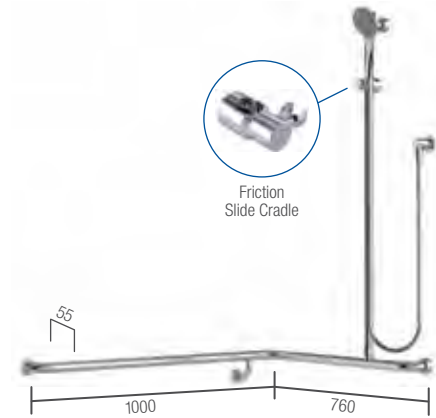

Drawn RH (Right Hand)



Drawn LH (Left Hand)

Code	Finish	Features
HS 01805 C LH	Chrome	<ul style="list-style-type: none"> • 760mm x 1000mm x 1100mm grab rail • 32mm grab rail fabricated from 304 stainless steel • 50mm Hygienic Seal® with Biomaster antimicrobial additive • Friction Slide handset cradle • Hoscare® handpiece with Biomaster antimicrobial additive • Chrome plated DR brass wall outlet elbow • Flow Interchange® spigot • Licenced dual check/non-return as per WaterMark AS/NZS 2845.1 WMKA 02696 • 57mm solid brass round flat flange • 1500mm Silverflex PVC shower hose • Available in 3 Star 9L/min and 4 Star 6.5L/min as per WELS licence number 0046 • Meets the requirements of AS 1428.1:2021 Design for access and mobility
HS 01805 C LH/6.5	Chrome	
HS 01805 C RH	Chrome	
HS 01805 C RH/6.5	Chrome	
HS 01805 CC LH	Commercial Chrome	
HS 01805 CC LH/6.5	Commercial Chrome	
HS 01805 CC RH	Commercial Chrome	
HS 01805 CC RH/6.5	Commercial Chrome	

- 760mm x 1000mm x 1100mm grab rail
- 32mm grab rail fabricated from 304 stainless steel
- 50mm Hygienic Seal® with Biomaster antimicrobial additive
- Friction Slide handset cradle
- Hoscare® handpiece with Biomaster antimicrobial additive
- Chrome plated DR brass wall outlet elbow
- Flow Interchange® spigot
- Licenced dual check/non-return as per WaterMark AS/NZS 2845.1 WMKA 02696
- 57mm solid brass round flat flange
- 1500mm Silverflex PVC shower hose
- Available in 3 Star 9L/min and 4 Star 6.5L/min as per WELS licence number 0046
- Meets the requirements of AS 1428.1:2021 Design for access and mobility



Options available on request

- ABS Grab Rail Soap Dish Holder - see page 94

HYGIENIC SEAL® SHOWER KIT 13

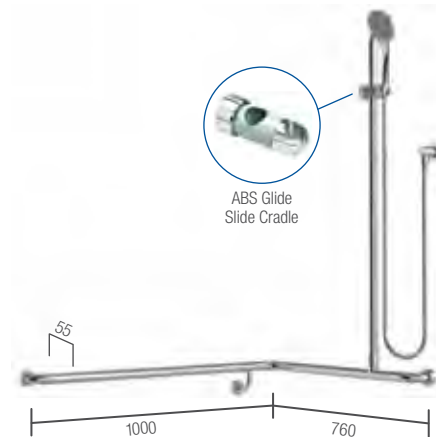

Drawn RH (Right Hand)



Drawn LH (Left Hand)

Code	Finish	Features
HS 01813 C LH	Chrome	<ul style="list-style-type: none"> • 900mm grab rail • 32mm grab rail fabricated from 304 stainless steel • 50mm Hygienic Seal® with Biomaster antimicrobial additive • ABS Glide Slide handset cradle • Hoscare® handpiece with Biomaster antimicrobial additive • Chrome plated DR brass wall outlet elbow • Flow Interchange® spigot • Licenced dual check/non-return as per WaterMark AS/NZS 2845.1 WMKA 02696 • 57mm solid brass round flat flange • 1500mm Silverflex PVC shower hose • WaterMark AS/NZS 3662 WMKT 21147 • Available in 3 Star 9L/min and 4 Star 6.5L/min as per WELS licence number 0046 • Meets the requirements of AS 1428.1:2021 Design for access and mobility
HS 01813 C LH/6.5	Chrome	
HS 01813 C RH	Chrome	
HS 01813 C RH/6.5	Chrome	
HS 01813 CC LH	Commercial Chrome	
HS 01813 CC LH/6.5	Commercial Chrome	
HS 01813 CC RH	Commercial Chrome	
HS 01813 CC RH/6.5	Commercial Chrome	

- 900mm grab rail
- 32mm grab rail fabricated from 304 stainless steel
- 50mm Hygienic Seal® with Biomaster antimicrobial additive
- ABS Glide Slide handset cradle
- Hoscare® handpiece with Biomaster antimicrobial additive
- Chrome plated DR brass wall outlet elbow
- Flow Interchange® spigot
- Licenced dual check/non-return as per WaterMark AS/NZS 2845.1 WMKA 02696
- 57mm solid brass round flat flange
- 1500mm Silverflex PVC shower hose
- WaterMark AS/NZS 3662 WMKT 21147
- Available in 3 Star 9L/min and 4 Star 6.5L/min as per WELS licence number 0046
- Meets the requirements of AS 1428.1:2021 Design for access and mobility



Options available on request

- ABS Grab Rail Soap Dish Holder - see page 94

HYGIENIC SEAL® COMMERCIAL SHOWER KITS

Hygienic Seal® healthcare showers are made from quality materials and feature dual check facilities as per AS/NZ 3500. All kits include Hygienic Seal® 32mm grab rails assembled with 50mm flange covers featuring Biomaster Thermoplastic Elastomer (TPE) seals, and are WELS rated as per licence number 0046.

	Code	Finish	Features
HYGIENIC SEAL® SHOWER KIT 20			
<p>1100</p> <p>700</p> <p>55</p> <p>Friction Slide Cradle</p> <p>Drawn LH (Left Hand)</p>	HS 01820 C LH	Chrome	<ul style="list-style-type: none"> • 700mm x 1100mm grab rail • 32mm grab rail fabricated from 304 stainless steel • 50mm Hygienic Seal® with Biomaster antimicrobial additive • Friction Slide handset cradle • Hoscare® handpiece with Biomaster antimicrobial additive • Chrome plated DR brass wall outlet elbow • Flow Interchange® spigot • Licenced dual check/non-return as per WaterMark AS/NZS 2845.1 WMKA 02696 • 57mm solid brass round flat flange • 1500mm Silverflex PVC shower hose • WaterMark AS/NZS 3662 WMKT 21147 • Available in 3 Star 9L/min and 4 Star 6.5L/min as per WELS licence number 0046 • Meets the requirements of AS 1428.1:2021 Design for access and mobility <p>Options available on request</p> <ul style="list-style-type: none"> • ABS Grab Rail Soap Dish Holder - see page 94
	HS 01820 C RH	Chrome	
	HS 01820 C/6.5 LH	Chrome	
	HS 01820 C/6.5 RH	Chrome	
	HS 01820 CC LH	Commercial Chrome	
	HS 01820 CC RH	Commercial Chrome	
	HS 01820 CC/6.5 LH	Commercial Chrome	
	HS 01820 CC/6.5 RH	Commercial Chrome	
	HYGIENIC SEAL® SHOWER KIT 16		
<p>1100</p> <p>700</p> <p>55</p> <p>ABS Glide Slide Cradle</p> <p>Drawn LH (Left Hand)</p>	HS 01816 C LH	Chrome	<ul style="list-style-type: none"> • 700mm x 1100mm grab rail • 32mm grab rail fabricated from 304 stainless steel • 50mm Hygienic Seal® with Biomaster antimicrobial additive • ABS Glide Slide handset cradle • Hoscare® handpiece with Biomaster antimicrobial additive • Chrome plated DR brass wall outlet elbow • Flow Interchange® spigot • Licenced dual check/non-return as per WaterMark AS/NZS 2845.1 WMKA 02696 • 57mm solid brass round flat flange • 1500mm Silverflex PVC shower hose • WaterMark AS/NZS 3662 WMKT 21147 • Available in 3 Star 9L/min and 4 Star 6.5L/min as per WELS licence number 0046 • Meets the requirements of AS 1428.1:2021 Design for access and mobility <p>Options available on request</p> <ul style="list-style-type: none"> • ABS Grab Rail Soap Dish Holder - see page 94
	HS 01816 C RH	Chrome	
	HS 01816 C/6.5 LH	Chrome	
	HS 01816 C/6.5 RH	Chrome	
	HS 01816 CC LH	Commercial Chrome	
	HS 01816 CC RH	Commercial Chrome	
	HS 01816 CC/6.5 LH	Commercial Chrome	
	HS 01816 CC/6.5 RH	Commercial Chrome	



Biomaster antimicrobial seals for added protection against bacteria

LINEAR GRAB RAILS - TOWEL GRAB RAILS & ACCESSIBLE TOILET ASSIST

Con-Serv's superior grab rail range, the Linear combines the quality of the Hygienic Seal® grab rail with the classic profile of a 'T' leg linear flange delivering both style and sophistication. Ideal in domestic and commercial environments, Linear grab rails are available in a variety of sizes and finishes.



	Code	Finish	Features
LINEAR TOWEL GRAB RAILS "D" SHAPE			
	LT 600 BS D	Brushed Stainless	<ul style="list-style-type: none"> • 600mm and 800mm towel grab rails, centre to centre • 32mm grab rail fabricated from 304 stainless steel • Assembled with 50mm brass screw on flange covers with Biomaster Thermoplastic Elastomer (TPE) fitted seals • Stainless steel fixing screws supplied
	LT 600 MB D	Matte Black	
	LT 600 PS D	Polish Supreme™	
	LT 800 BS D	Brushed Stainless	
	LT 800 MB D	Matte Black	
	LT 800 PS D	Polish Supreme™	
LINEAR TOWEL GRAB RAILS "U" SHAPE			
	LT 600 BS U	Brushed Stainless	<ul style="list-style-type: none"> • 600mm and 800mm towel grab rails, centre to centre • 32mm grab rail fabricated from 304 stainless steel • Assembled with 50mm brass screw on flange covers with Biomaster Thermoplastic Elastomer (TPE) fitted seals • Stainless steel fixing screws supplied • Meets the requirements of AS 1428.1:2021 Design for access and mobility
	LT 600 MB U	Matte Black	
	LT 600 PS U	Polish Supreme™	
	LT 800 BS U	Brushed Stainless	
	LT 800 MB U	Matte Black	
	LT 800 PS U	Polish Supreme™	
LINEAR 40° AMBULANT AND ACCESSIBLE GRAB RAILS 450MM X 450MM			
<p>Drawn LH (Left Hand)</p>	LR 045 BS LH	Brushed Stainless	<ul style="list-style-type: none"> • 450mm x 450mm • 32mm grab rail fabricated from 304 stainless steel • Assembled with 50mm brass screw on flange covers with Biomaster Thermoplastic Elastomer (TPE) fitted seals • Stainless steel fixing screws supplied • Meets the requirements of AS 1428.1:2021 Design for access and mobility
	LR 045 BS RH	Brushed Stainless	
	LR 045 MB LH	Matte Black	
	LR 045 MB RH	Matte Black	
	LR 045 PS LH	Polish Supreme™	
	LR 045 PS RH	Polish Supreme™	
LINEAR 40° AMBULANT AND ACCESSIBLE GRAB RAILS 870MM X 700MM			
<p>Drawn LH (Left Hand)</p>	LR 877 BS LH	Brushed Stainless	<ul style="list-style-type: none"> • 870mm x 700mm • 32mm grab rail fabricated from 304 stainless steel • Assembled with 50mm brass screw on flange covers with Biomaster Thermoplastic Elastomer (TPE) fitted seals • Stainless steel fixing screws supplied • Meets the requirements of AS 1428.1:2021 Design for access and mobility
	LR 877 BS RH	Brushed Stainless	
	LR 877 MB LH	Matte Black	
	LR 877 MB RH	Matte Black	
	LR 877 PS LH	Polish Supreme™	
	LR 877 PS RH	Polish Supreme™	
LINEAR 90° AMBULANT AND ACCESSIBLE GRAB RAILS 450MM X 450MM			
<p>Drawn LH (Left Hand)</p>	LR 454 BS LH	Brushed Stainless	<ul style="list-style-type: none"> • 450mm x 450mm • 32mm grab rail fabricated from 304 stainless steel • Assembled with 50mm brass screw on flange covers with Biomaster Thermoplastic Elastomer (TPE) fitted seals • Stainless steel fixing screws supplied • Meets the requirements of AS 1428.1:2021 Design for access and mobility
	LR 454 BS RH	Brushed Stainless	
	LR 454 MB LH	Matte Black	
	LR 454 MB RH	Matte Black	
	LR 454 PS LH	Polish Supreme™	
	LR 454 PS RH	Polish Supreme™	
LINEAR 90° AMBULANT AND ACCESSIBLE GRAB RAILS 960MM X 600MM			
<p>Drawn LH (Left Hand)</p>	LR 966 BS LH	Brushed Stainless	<ul style="list-style-type: none"> • 960mm x 600mm • 32mm grab rail fabricated from 304 stainless steel • Assembled with 50mm brass screw on flange covers with Biomaster Thermoplastic Elastomer (TPE) fitted seals • Stainless steel fixing screws supplied • Meets the requirements of AS 1428.1:2021 Design for access and mobility
	LR 966 BS RH	Brushed Stainless	
	LR 966 MB LH	Matte Black	
	LR 966 MB RH	Matte Black	
	LR 966 PS LH	Polish Supreme™	
	LR 966 PS RH	Polish Supreme™	



All dimensions are in millimetres unless otherwise specified.



LINEAR SHOWER - 900MM



- 900mm grab rail
- Meets requirements of AS 1428.1:2021
- Hygienic Seal® flange with antimicrobial seals
- DR brass wall outlet elbow
- Brass Friction Slide Cradle
- ABS handpiece with rub-clean diffuser
- PVC 1500mm Silverflex™ hose
- Licenced dual check/non-return valve
- Brass 57mm wall flange
- Stainless steel fixings supplied



Model Code Finish Features



STREAMJET™			
	LF 900J BN	Brushed Nickel	<ul style="list-style-type: none"> • ABS 100mm single function shower • Concentric full pattern spray • Rub-clean spray diffuser • WaterMark AS 3662 WMKT 21147 • Available in 3 Star 9L/min and 4 Star 6.5L/min as per WELS licence number 0046 
	LF 900J BN/6.5	Brushed Nickel	
	LF 900J C	Chrome	
	LF 900J C/6.5	Chrome	
	LF 900J MB	Matte Black	
	LF 900J MB/6.5	Matte Black	

STREAMJET™ TURBO PULSATOR				
	LF 900T C	Chrome	<ul style="list-style-type: none"> • ABS 100mm multi-function shower • Soft, pulsating and bubble spray functions • Rub-clean spray diffuser • WaterMark AS 3662 WMKT 21147 • Available in 3 Star 9L/min as per WELS licence number 0046 	

STREAMJET™ XL			
	LF 900X BN	Brushed Nickel	<ul style="list-style-type: none"> • ABS 130mm single function shower • Concentric full pattern spray • Rub-clean spray diffuser • WaterMark AS 3662 WMKT 21147 • Available in 3 Star 9L/min as per WELS licence number 0046 
	LF 900X C	Chrome	
	LF 900X MB	Matte Black	

STREAMJET™ XL TURBO PULSATOR				
	LF 900S C	Chrome	<ul style="list-style-type: none"> • ABS 130mm multi-function shower • Soft, pulsating and bubble spray functions • Rub-clean spray diffuser • WaterMark AS 3662 WMKT 21147 • Available in 3 Star 9L/min as per WELS licence number 0046 	

PRINCESS				
	LF 900P C	Chrome	<ul style="list-style-type: none"> • ABS 83mm arched single function shower • Full pattern spray • Rub-clean spray diffuser • WaterMark AS 3662 WMKT 21147 • Available in 3 Star 9L/min as per WELS licence number 0046 	

BREEZE				
	LF 900Z C	Chrome	<ul style="list-style-type: none"> • ABS 104mm arched multi-function shower • Soft, pulsating and bubble spray functions • Rub-clean spray diffuser • Available in 3 Star 9L/min as per WELS licence number 0046 	

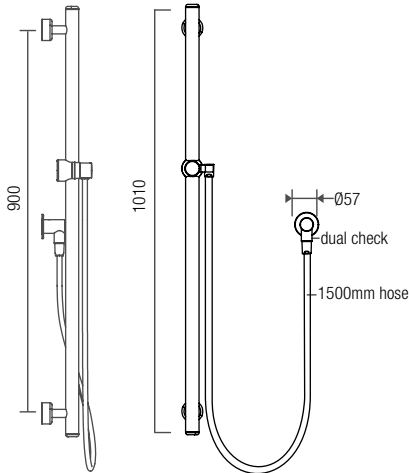
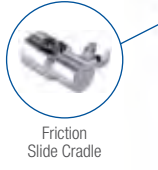







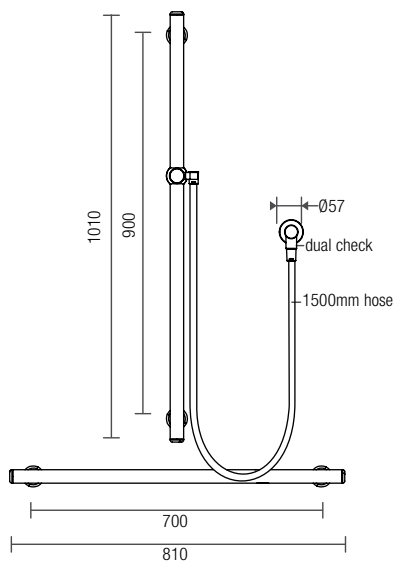



Model shown: LF 900J C

LINEAR SHOWER - 900MM & 700MM

- 700mm & 900mm grab rails
- Meets requirements of AS 1428.1:2021
- Hygienic Seal® flange with antimicrobial seals
- DR brass wall outlet elbow
- Brass Friction Slide Cradle
- ABS handpiece with rub-clean diffuser
- PVC 1500mm Silverflex™ hose
- Licenced dual check/non-return valve
- Brass 57mm wall flange
- Stainless steel fixings supplied

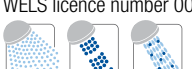

Model shown: LF 079J C

Model	Code	Finish	Features
STREAMJET™			
	LF 079J BN	Brushed Nickel	<ul style="list-style-type: none"> • ABS 100mm single function shower • Concentric full pattern spray • Rub-clean spray diffuser • WaterMark AS 3662 WMKT 21147 • Available in 3 Star 9L/min and 4 Star 6.5L/min as per WELS licence number 0046 
	LF 079J BN/6.5	Brushed Nickel	
	LF 079J C	Chrome	
	LF 079J C/6.5	Chrome	
	LF 079J MB	Matte Black	
	LF 079J MB/6.5	Matte Black	
STREAMJET™ TURBO PULSATOR			
	LF 079T C	Chrome	<ul style="list-style-type: none"> • ABS 100mm multi-function shower • Soft, pulsating and bubble spray functions • Rub-clean spray diffuser • WaterMark AS 3662 WMKT 21147 • Available in 3 Star 9L/min as per WELS licence number 0046 
STREAMJET™ XL			
	LF 079X BN	Brushed Nickel	<ul style="list-style-type: none"> • ABS 130mm single function shower • Concentric full pattern spray • Rub-clean spray diffuser • WaterMark AS 3662 WMKT 21147 • Available in 3 Star 9L/min as per WELS licence number 0046 
	LF 079X C	Chrome	
	LF 079X MB	Matte Black	
STREAMJET™ XL TURBO PULSATOR			
	LF 079S C	Chrome	<ul style="list-style-type: none"> • ABS 130mm multi-function shower • Soft, pulsating and bubble spray functions • Rub-clean spray diffuser • WaterMark AS 3662 WMKT 21147 • Available in 3 Star 9L/min as per WELS licence number 0046 
PRINCESS			
	LF 079P C	Chrome	<ul style="list-style-type: none"> • ABS 83mm arched single function shower • Full pattern spray • Rub-clean spray diffuser • WaterMark AS 3662 WMKT 21147 • Available in 3 Star 9L/min as per WELS licence number 0046 
BREEZE			
	LF 079Z C	Chrome	<ul style="list-style-type: none"> • ABS 104mm arched multi-function shower • Soft, pulsating and bubble spray functions • Rub-clean spray diffuser • Available in 3 Star 9L/min as per WELS licence number 0046 

LINEAR TWIN WATERS™ - 450MM

- 1100mm grab rail
- Stainless steel 400mm swivelling shower arm
- Meets requirements of AS 1428.1:2021
- ABS 256mm rainmaker shower
- ABS handpiece with rub-clean diffuser
- PVC 1500mm Silverflex™ hose
- Diverter switchcock valve
- Licenced dual check/non-return valve
- Stainless steel fixings supplied



Model	Code	Finish	Features	
STREAMJET™				
	TOP INLET		<ul style="list-style-type: none"> • ABS 100mm single function shower • Concentric full pattern spray • Rub-clean spray diffuser • WaterMark AS 3662 WMKT 21147 • Available in 3 Star 9L/min and 4 Star 6.5L/min as per WELS licence number 0046 	
	LT 110CJ BN 45	Brushed Nickel		
	LT 110CJ C 45	Chrome		
	BOTTOM INLET			
LT 111CJ BN 45	Brushed Nickel			
LT 111CJ C 45	Chrome			
STREAMJET™ TURBO PULSATOR				
	TOP INLET			<ul style="list-style-type: none"> • ABS 100mm multi-function shower • Soft, pulsating and bubble spray functions • Rub-clean spray diffuser • WaterMark AS 3662 WMKT 21147 • Available in 3 Star 9L/min as per WELS licence number 0046 
	LT 110CT C 45	Chrome		
	BOTTOM INLET			
	LT 111CT C 45	Chrome		
STREAMJET™ XL				
	TOP INLET		<ul style="list-style-type: none"> • ABS 130mm single function shower • Concentric full pattern spray • Rub-clean spray diffuser • WaterMark AS 3662 WMKT 21147 • Available in 3 Star 9L/min as per WELS licence number 0046 	
	LT 110CX BN 45	Brushed Nickel		
	LT 110CX C 45	Chrome		
	BOTTOM INLET			
LT 111CX BN 45	Brushed Nickel			
LT 111CX C 45	Chrome			
STREAMJET™ XL TURBO PULSATOR				
	TOP INLET			<ul style="list-style-type: none"> • ABS 130mm multi-function shower • Soft, pulsating and bubble spray functions • Rub-clean spray diffuser • WaterMark AS 3662 WMKT 21147 • Available in 3 Star 9L/min as per WELS licence number 0046 
	LT 110CS C 45	Chrome		
	BOTTOM INLET			
	LT 111CS C 45	Chrome		
PRINCESS				
	TOP INLET		<ul style="list-style-type: none"> • ABS 83mm arched single function shower • Full pattern spray • Rub-clean spray diffuser • WaterMark AS 3662 WMKT 21147 • Available in 3 Star 9L/min as per WELS licence number 0046 	
	LT 110CP C 45	Chrome		
	BOTTOM INLET			
	LT 111CP C 45	Chrome		
BREEZE				
	TOP INLET			<ul style="list-style-type: none"> • ABS 104mm arched multi-function shower • Soft, pulsating and bubble spray functions • Rub-clean spray diffuser • Available in 3 Star 9L/min as per WELS licence number 0046 
	LT 110CZ C 45	Chrome		
	BOTTOM INLET			
	LT 111CZ C 45	Chrome		



Model shown: LT 110CP C 45

LINEAR TWIN WATERS™ - 650MM

- 1100mm grab rail
- Stainless steel 600mm swivelling shower arm
- Meets requirements of AS 1428.1:2021
- ABS 256mm rainmaker shower
- ABS handpiece with rub-clean diffuser
- PVC 1500mm Silverflex™ hose
- Diverter switchcock valve
- Licenced dual check/non-return valve
- Stainless steel fixings supplied

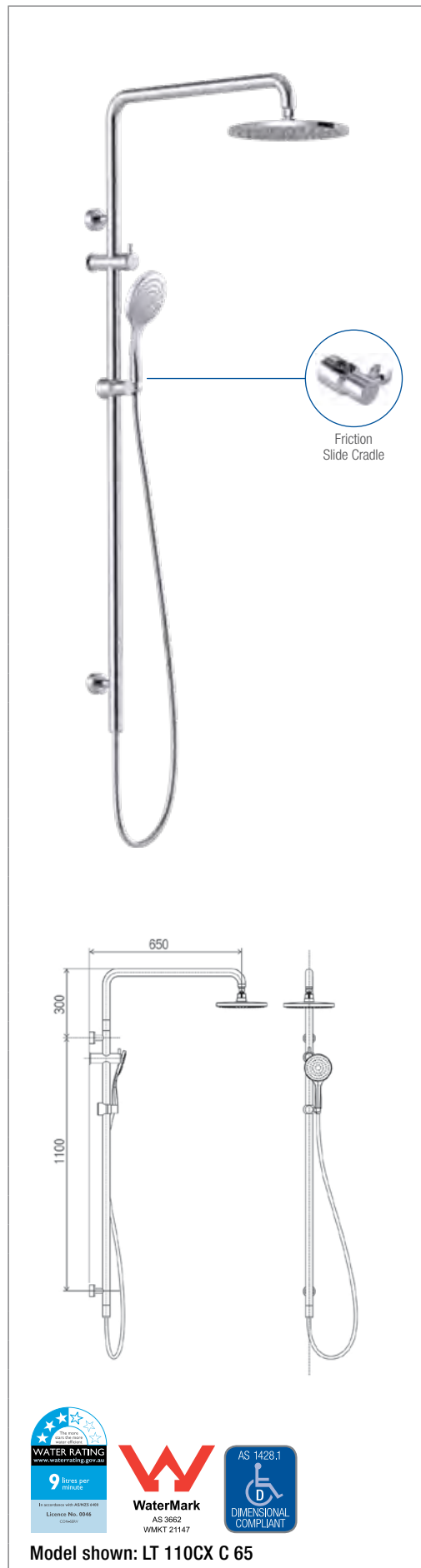

Model	Code	Finish	Features	
STREAMJET™				
TOP INLET			<ul style="list-style-type: none"> • ABS 100mm single function shower • Concentric full pattern spray • Rub-clean spray diffuser • WaterMark AS 3662 WMKT 21147 • Available in 3 Star 9L/min and 4 Star 6.5L/min as per WELS licence number 0046 	
LT 110CJ BN 65	Brushed Nickel			
LT 110CJ C 65	Chrome			
BOTTOM INLET				
LT 111CJ BN 65	Brushed Nickel			
LT 111CJ C 65	Chrome			
STREAMJET™ TURBO PULSATOR				
TOP INLET			<ul style="list-style-type: none"> • ABS 100mm multi-function shower • Soft, pulsating and bubble spray functions • Rub-clean spray diffuser • WaterMark AS 3662 WMKT 21147 • Available in 3 Star 9L/min as per WELS licence number 0046 	
LT 110CT C 65	Chrome			
BOTTOM INLET				
LT 111CT C 65	Chrome			
STREAMJET™ XL				
TOP INLET				<ul style="list-style-type: none"> • ABS 130mm single function shower • Concentric full pattern spray • Rub-clean spray diffuser • WaterMark AS 3662 WMKT 21147 • Available in 3 Star 9L/min as per WELS licence number 0046 
LT 110CX BN 65	Brushed Nickel			
LT 110CX C 65	Chrome			
BOTTOM INLET				
LT 111CX BN 65	Brushed Nickel			
LT 111CX C 65	Chrome			
STREAMJET™ XL TURBO PULSATOR				
TOP INLET			<ul style="list-style-type: none"> • ABS 130mm multi-function shower • Soft, pulsating and bubble spray functions • Rub-clean spray diffuser • WaterMark AS 3662 WMKT 21147 • Available in 3 Star 9L/min as per WELS licence number 0046 	
LT 110CS C 65	Chrome			
BOTTOM INLET				
LT 111CS C 65	Chrome			
PRINCESS				
TOP INLET				<ul style="list-style-type: none"> • ABS 83mm arched single function shower • Full pattern spray • Rub-clean spray diffuser • WaterMark AS 3662 WMKT 21147 • Available in 3 Star 9L/min as per WELS licence number 0046 
LT 110CP C 65	Chrome			
BOTTOM INLET				
LT 111CP C 65	Chrome			
BREEZE				
TOP INLET			<ul style="list-style-type: none"> • ABS 104mm arched multi-function shower • Soft, pulsating and bubble spray functions • Rub-clean spray diffuser • Available in 3 Star 9L/min as per WELS licence number 0046 	
LT 110CZ C 65	Chrome			
BOTTOM INLET				
LT 111CZ C 65	Chrome			







Model shown: LT 110CX C 65



LINEAR TWIN WATERS™ - INVERTED "T" 450MM



- 700mm x 1100mm grab rail
- Stainless steel 400mm swivelling shower arm
- Meets requirements of AS 1428.1:2021
- ABS 256mm rainmaker shower
- ABS handpiece with rub-clean diffuser
- PVC 1500mm Silverflex™ hose
- Diverter switchcock valve
- Licenced dual check/non-return valve
- Stainless steel fixings supplied



Model Code Finish Features



STREAMJET™			
	LT 071CJ BN L45	Brushed Nickel	<ul style="list-style-type: none"> • ABS 100mm single function shower • Concentric full pattern spray • Rub-clean spray diffuser • WaterMark AS 3662 WMKT 21147 • Available in 3 Star 9L/min and 4 Star 6.5L/min as per WELS licence number 0046 
	LT 071CJ BN M45	Brushed Nickel	
	LT 071CJ BN R45	Brushed Nickel	
	LT 071CJ C L45	Chrome	
	LT 071CJ C M45	Chrome	
	LT 071CJ C R45	Chrome	

STREAMJET™ TURBO PULSATOR			
	LT 071CT C L45	Chrome	<ul style="list-style-type: none"> • ABS 100mm multi-function shower • Soft, pulsating and bubble spray functions • Rub-clean spray diffuser • WaterMark AS 3662 WMKT 21147 • Available in 3 Star 9L/min as per WELS licence number 0046 
	LT 071CT C M45	Chrome	
	LT 071CT C R45	Chrome	

STREAMJET™ XL			
	LT 071CX BN L45	Brushed Nickel	<ul style="list-style-type: none"> • ABS 130mm single function shower • Concentric full pattern spray • Rub-clean spray diffuser • WaterMark AS 3662 WMKT 21147 • Available in 3 Star 9L/min as per WELS licence number 0046 
	LT 071CX BN M45	Brushed Nickel	
	LT 071CX BN R45	Brushed Nickel	
	LT 071CX C L45	Chrome	
	LT 071CX C M45	Chrome	
	LT 071CX C R45	Chrome	

STREAMJET™ XL TURBO PULSATOR			
	LT 071CS C L45	Chrome	<ul style="list-style-type: none"> • ABS 130mm multi-function shower • Soft, pulsating and bubble spray functions • Rub-clean spray diffuser • WaterMark AS 3662 WMKT 21147 • Available in 3 Star 9L/min as per WELS licence number 0046 
	LT 071CS C M45	Chrome	
	LT 071CS C R45	Chrome	

PRINCESS			
	LT 071CP C L45	Chrome	<ul style="list-style-type: none"> • ABS 83mm arched single function shower • Full pattern spray • Rub-clean spray diffuser • WaterMark AS 3662 WMKT 21147 • Available in 3 Star 9L/min as per WELS licence number 0046 
	LT 071CP C M45	Chrome	
	LT 071CP C R45	Chrome	

BREEZE			
	LT 071CZ C L45	Chrome	<ul style="list-style-type: none"> • ABS 104mm arched multi-function shower • Soft, pulsating and bubble spray functions • Rub-clean spray diffuser • Available in 3 Star 9L/min as per WELS licence number 0046 
	LT 071CZ C M45	Chrome	
	LT 071CZ C R45	Chrome	



Friction Slide Cradle

Drawn RH (Right Hand)

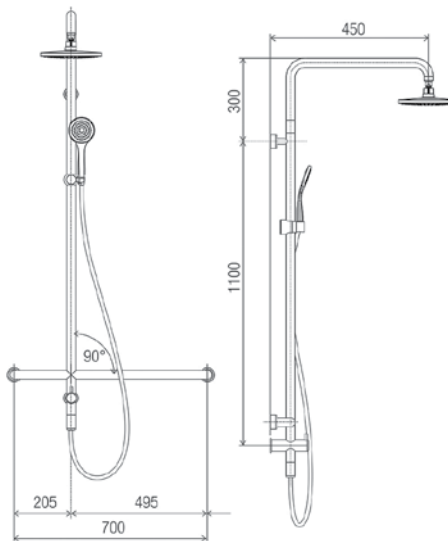

Model shown: LT 071CJ C R45

LINEAR TWIN WATERS™ - INVERTED "T" 650MM

- 700mm x 1100mm Polish Supreme™ grab rail
- Stainless steel 600mm swivelling shower arm
- Meets requirements of AS 1428.1:2021
- ABS 256mm rainmaker shower
- ABS handpiece with rub-clean diffuser
- PVC 1500mm Silverflex™ hose
- Diverter switchcock valve
- Licenced dual check/non-return valve
- Stainless steel fixings supplied





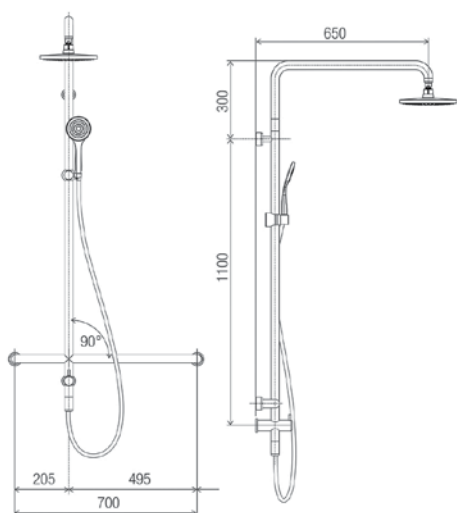







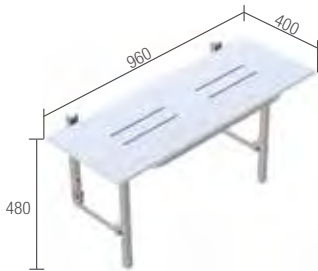

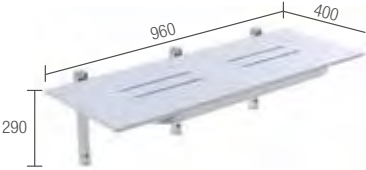

Drawn LH (Left Hand)



Model shown: LT 071CJ C L65

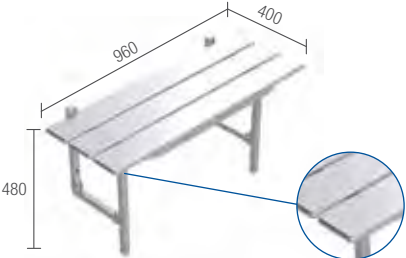

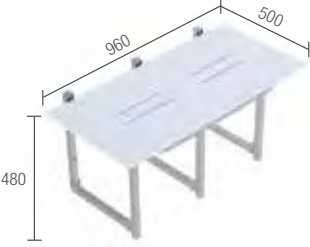







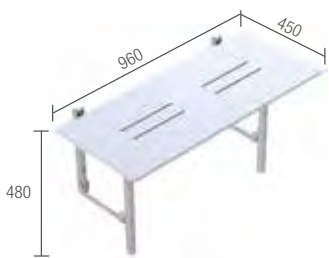

Model	Code	Finish	Features
STREAMJET™			
	LT 071CJ BN L65	Brushed Nickel	<ul style="list-style-type: none"> • ABS 100mm single function shower • Concentric full pattern spray • Rub-clean spray diffuser • WaterMark AS 3662 WMKT 21147 • Available in 3 Star 9L/min and 4 Star 6.5L/min as per WELS licence number 0046
	LT 071CJ BN M65	Brushed Nickel	
	LT 071CJ BN R65	Brushed Nickel	
	LT 071CJ C L65	Chrome	
	LT 071CJ C M65	Chrome	
	LT 071CJ C R65	Chrome	
STREAMJET™ TURBO PULSATOR			
	LT 071CT C L65	Chrome	<ul style="list-style-type: none"> • ABS 100mm multi-function shower • Soft, pulsating and bubble spray functions • Rub-clean spray diffuser • WaterMark AS 3662 WMKT 21147 • Available in 3 Star 9L/min as per WELS licence number 0046
	LT 071CT C M65	Chrome	
	LT 071CT C R65	Chrome	
STREAMJET™ XL			
	LT 071CX BN L65	Brushed Nickel	<ul style="list-style-type: none"> • ABS 130mm single function shower • Concentric full pattern spray • Rub-clean spray diffuser • WaterMark AS 3662 WMKT 21147 • Available in 3 Star 9L/min as per WELS licence number 0046
	LT 071CX BN M65	Brushed Nickel	
	LT 071CX BN R65	Brushed Nickel	
	LT 071CX C L65	Chrome	
	LT 071CX C M65	Chrome	
	LT 071CX C R65	Chrome	
STREAMJET™ XL TURBO PULSATOR			
	LT 071CS C L65	Chrome	<ul style="list-style-type: none"> • ABS 130mm multi-function shower • Soft, pulsating and bubble spray functions • Rub-clean spray diffuser • WaterMark AS 3662 WMKT 21147 • Available in 3 Star 9L/min as per WELS licence number 0046
	LT 071CS C M65	Chrome	
	LT 071CS C R65	Chrome	
PRINCESS			
	LT 071CP C L65	Chrome	<ul style="list-style-type: none"> • ABS 83mm arched single function shower • Full pattern spray • Rub-clean spray diffuser • WaterMark AS 3662 WMKT 21147 • Available in 3 Star 9L/min as per WELS licence number 0046
	LT 071CP C M65	Chrome	
	LT 071CP C R65	Chrome	
BREEZE			
	LT 071CZ C L65	Chrome	<ul style="list-style-type: none"> • ABS 104mm arched multi-function shower • Soft, pulsating and bubble spray functions • Rub-clean spray diffuser • Available in 3 Star 9L/min as per WELS licence number 0046
	LT 071CZ C M65	Chrome	
	LT 071CZ C R65	Chrome	

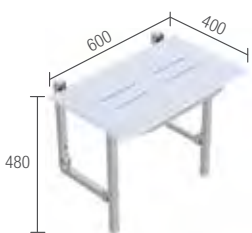
Shower Seats

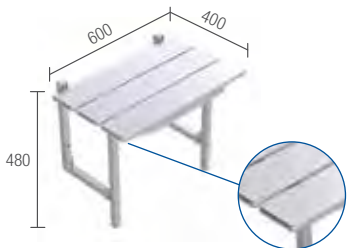
	Code	Finish	Features
ACCESSIBLE SUITES			
	SS 964 BS	Brushed Stainless	<ul style="list-style-type: none"> • Seat size: 960mm x 400mm • Folding legs for added support • Assembled with UV stabilised, fade resistant High Density Polyethylene (HDPE) seat deck with self draining channels • Frame fabricated from 304 stainless steel • Maximum load 250kg • Stainless steel fixing screws supplied • Meets the requirements of AS 1428.1:2021 Design for access and mobility  
	SS 964 BSB	Brushed Stainless/Black Seat	
	SS 964 MB	Matte Black	
	SS 964 PS	Polish Supreme™	
	SS 964 WT	White	
SHOWER SEAT LEG EXTENSIONS (PR) 50MM M- 200MM			
	SS 964 BS LE	Brushed Stainless	<ul style="list-style-type: none"> • Increased leg length (max. 200mm) • Ideal for installations where floor is not level • Fabricated from 304 stainless steel • Suitable for SS 604, SS 845 & SS 964 models only 
	SS 964 PS LE	Polish Supreme™	
WHEELCHAIR TRANSFER			
	SS 964 BS WM	Brushed Stainless	<ul style="list-style-type: none"> • Seat size: 960mm x 400mm • Transfer conveniently from wheelchair • Assembled with UV stabilised, fade resistant High Density Polyethylene (HDPE) seat deck with self draining channels • Frame fabricated from 304 stainless steel • Maximum load 250kg • Stainless steel fixing screws supplied • Meets the requirements of AS 1428.1:2021 Design for access and mobility  
	SS 964 BSB WM	Brushed Stainless/Black Seat	
COVERED WALLS			
	SS 964 BS CW	Brushed Stainless	<ul style="list-style-type: none"> • Seat size: 960mm x 400mm • Floor mounted - Rear leg fastening • Assembled with UV stabilised, fade resistant High Density Polyethylene (HDPE) seat deck with self draining channels • Frame fabricated from 304 stainless steel • Maximum load 250kg • Stainless steel fixing screws supplied • Meets the requirements of AS 1428.1:2021 Design for access and mobility  
SLATTED SEAT DECK			
	SS 964 AW ME	Antimicrobial White	<ul style="list-style-type: none"> • Seat size: 960mm x 400mm • 3 part slatted seat deck fabricated from 304 stainless steel, self draining • Frame fabricated from 304 stainless steel • Maximum load 250kg • Stainless steel fixing screws supplied • Meets the requirements of AS 1428.1:2021 Design for access and mobility  
	SS 964 BS ME	Brushed Stainless	
	SS 964 MB ME	Matte Black	
BARIATRIC SEAT FOR AREAS NOT STRICTLY DISABLED			
	SS 965 BS	Brushed Stainless	<ul style="list-style-type: none"> • Large seat size: 960mm x 500mm large seat • Additional centre support • Folding legs for added support • Assembled with UV stabilised, fade resistant High Density Polyethylene (HDPE) seat deck with self draining channels • Frame fabricated from 304 stainless steel • Maximum load 400kg • Stainless steel fixing screws supplied  

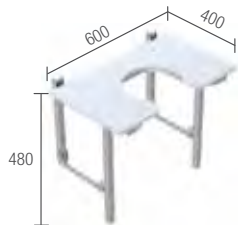
SHOWER SEATS

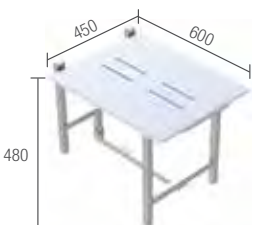
Con-Serv Folding Shower Seats have been designed for users who are unable, or find it difficult to shower while standing. Seat frames feature tension grip hinges for horizontal and vertical movement, fabricated from 304 stainless steel and secured to the seat deck with concealed 316 stainless steel screws. Seat decks are UV stabilised, tamper resistant, sanitary safe and fabricated from High Density Polyethylene (HDPE) with soft, round edges and self draining channels.

	Code	Finish	Features
FOLDING SHOWER SEAT SUITABLE FOR CHANGING PLACES 960MM x 450MM			
	SS 945 BS	Brushed Stainless	<ul style="list-style-type: none"> • Large seat size: 960mm x 450mm • Folding legs for added support • Assembled with UV stabilised, fade resistant High Density Polyethylene (HDPE) seat deck with self draining channels • Frame fabricated from 304 stainless steel • Maximum load 250kg • Stainless steel fixing screws supplied • Complies with clause 3.13.8 Folding seat of Changing Places Design Specifications 2020  
NEW ZEALAND STANDARDS NZS 4121:2001			
	SS 845 BS	Brushed Stainless	<ul style="list-style-type: none"> • Seat size: 800mm x 450mm • Assembled with UV stabilised, fade resistant High Density Polyethylene (HDPE) seat deck with self draining channels • Frame fabricated from 304 stainless steel • Maximum load 250kg • Stainless steel fixings screws supplied • Complies with New Zealand Standards NZS 4121:2001 
COMPACT SHOWER SEAT FOR AREAS NOT STRICTLY DISABLED			
	SS 604 BS	Brushed Stainless	<ul style="list-style-type: none"> • Seat size: 600mm x 400mm • Assembled with UV stabilised, fade resistant High Density Polyethylene (HDPE) seat deck with self draining channels • Frame fabricated from 304 stainless steel • Maximum load 160kg • Stainless steel fixings screws supplied 
	SS 604 PS	Polish Supreme™	
COMPACT SHOWER SEAT FOR AREAS NOT STRICTLY DISABLED			
	SS 604 BS ME	Brushed Stainless	<ul style="list-style-type: none"> • Seat size: 600mm x 400mm • 3 part slatted seat deck fabricated from 304 stainless steel, self draining • Frame fabricated from 304 stainless steel • Maximum load 160kg • Stainless steel fixings screws supplied 
SHOWER SEAT WITH CUTOUT FOR AREAS NOT STRICTLY DISABLED			
	SS 604 BS WA	Brushed Stainless	<ul style="list-style-type: none"> • Seat size: 600mm x 400mm • Convenient access for washing • Assembled with UV stabilised, fade resistant High Density Polyethylene (HDPE) seat deck with self draining channels • Frame fabricated from 304 stainless steel • Maximum load 160kg • Stainless steel fixings screws supplied 
SIDE LIFT SHOWER SEAT FOR AREAS NOT STRICTLY DISABLED			
	SS 645 BS	Brushed Stainless	<ul style="list-style-type: none"> • Seat size: 450mm x 600mm • Side lift option for limited wall space applications • Assembled with UV stabilised, fade resistant High Density Polyethylene (HDPE) seat deck with self draining channels • Frame fabricated from 304 stainless steel • Maximum load 160kg • Stainless steel fixing screws supplied • Patent Number 2008100882 

Folding, Swing and Floor/Wall Grab Rails

	Code	Finish	Features
TILTLOCK® 850MM GRAB RAIL			
 <p>Drawn LH (Left Hand)</p>	TL 850 AW LH	Antimicrobial White	<ul style="list-style-type: none"> • 850mm folding grab rail • Locks in horizontal or vertical positions • Chrome plated brass push button release, tensioning bolt and end cap • Fabricated from 32mm 304 stainless steel • Stainless steel fixings supplied • Suitable for non-compliant applications in hospitals, aged care facilities, and nursing homes • Safe working load 200kg downwards • Tested by ANTL (test report 4197.12-22.07.13)
	TL 850 AW RH	Antimicrobial White	
	TL 850 BS LH	Brushed Stainless	
	TL 850 BS RH	Brushed Stainless	
	TL 850 MB LH	Matte Black	
	TL 850 MB RH	Matte Black	
	TL 850 PS LH	Polish Supreme™	
	TL 850 PS RH	Polish Supreme™	
TILTLOCK® 850MM GRAB RAIL WITH STAINLESS STEEL FIXED TOILET PAPER HOLDER			
 <p>Drawn LH (Left Hand)</p>	TL 850 AW LHS	Antimicrobial White	<ul style="list-style-type: none"> • 850mm folding grab rail • Stainless steel toilet paper holder (Factory Fitted) • Locks in horizontal or vertical positions • Chrome plated brass push button release, tensioning bolt and end cap • Fabricated from 32mm 304 stainless steel • Stainless steel fixings supplied • Suitable for non-compliant applications in hospitals, aged care facilities and nursing homes • Safe working load 200kg downwards • Tested by ANTL (test report 4197.12-22.07.13)
	TL 850 AW RHS	Antimicrobial White	
	TL 850 BS LHS	Brushed Stainless	
	TL 850 BS RHS	Brushed Stainless	
	TL 850 MB LHS	Matte Black	
	TL 850 MB RHS	Matte Black	
	TL 850 PS LHS	Polish Supreme™	
	TL 850 PS RHS	Polish Supreme™	
TILTLOCK® 850MM GRAB RAIL WITH FLEXIBLE FIX TOILET PAPER HOLDER			
 <p>Drawn LH (Left Hand)</p>	TL 850 BS LHT	Brushed Stainless	<ul style="list-style-type: none"> • 850mm folding grab rail • Flexible ABS toilet paper holder • Locks in horizontal or vertical positions • Chrome plated brass push button release, tensioning bolt and end cap • Fabricated from 32mm 304 stainless steel • Stainless steel fixings supplied • Suitable for non-compliant applications in hospitals, aged care facilities and nursing homes • Safe working load 200kg downwards • Tested by ANTL (test report 4197.12-22.07.13)
	TL 850 BS RHT	Brushed Stainless	
	TL 850 PS LHT	Polish Supreme™	
	TL 850 PS RHT	Polish Supreme™	
TILTLOCK® 850MM GRAB RAIL WITH STAINLESS STEEL NURSE CALL MOUNT BOX			
 <p>Drawn LH (Left Hand)</p>	TL 850 BS LHN	Brushed Stainless	<ul style="list-style-type: none"> • 850mm folding grab rail • Factory fitted stainless steel nurse call mount box • Locks in horizontal or vertical positions • Chrome plated brass push button release, tensioning bolt and end cap • Fabricated from 32mm 304 stainless steel • Stainless steel fixings supplied • Suitable for non-compliant applications in hospitals, aged care facilities and nursing homes • Safe working load 200kg downwards • Tested by ANTL (test report 4197.12-22.07.13)
	TL 850 BS RHN	Brushed Stainless	
	TL 850 PS LHN	Polish Supreme™	
	TL 850 PS RHN	Polish Supreme™	

TILTLOCK® TWIN MOUNT

M8 X 75, stainless steel hexagon coach screws and 10mm wall plugs supplied with Tiltlock®

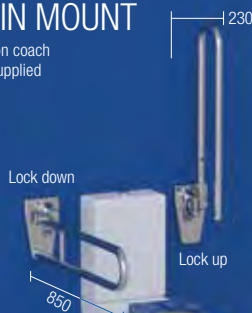



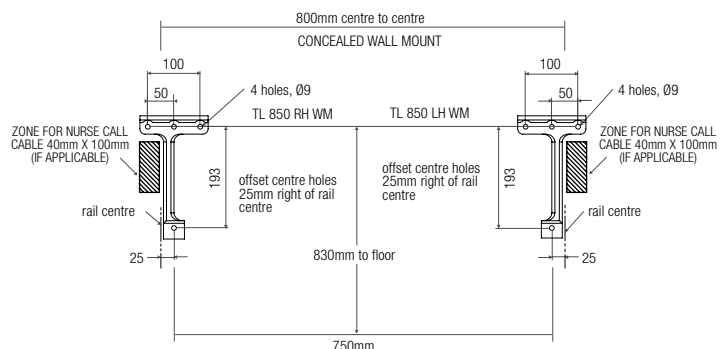





NO EXPOSED NUTS OR BOLTS

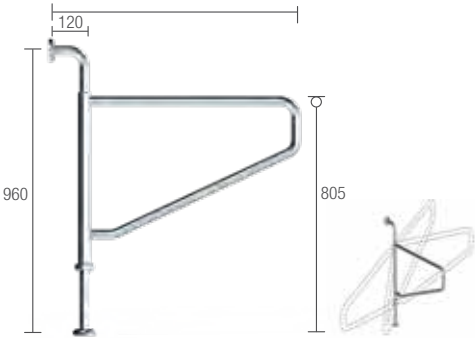
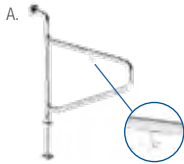

PATENT NUMBER: 2006100929

FOLDING, SWING AND FLOOR/WALL GRAB RAILS TILTLOCK®, SWINGLOCK®, FLOOR & LIFT-N-LOCK™

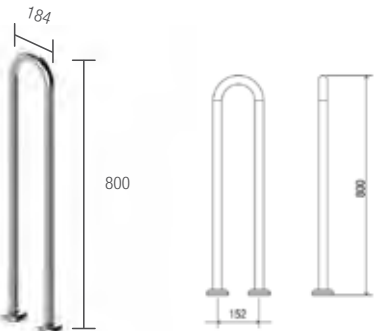
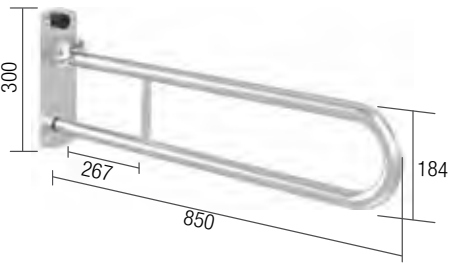
Con-Serv have grab rail solutions for all applications, including options for non-standard room configurations. Suited to non-accessible applications, Tiltlock®, Swinglock®, Lift'N'Lock™ and Floor/Wall Mounted grab rails are designed for functionality in difficult room layouts.

	Code	Finish	Features		
TILTLOCK® 850MM BARIATRIC FOLDING LEG GRAB RAIL					
 <p>Drawn RH (Right Hand)</p>	TL 850 BS LHBL	Brushed Stainless	<ul style="list-style-type: none"> • 850mm folding grab rail with folding leg • Reinforced for bariatric applications, maximum vertical load 400kg • Fabricated from 32mm 304 stainless steel • Locks in horizontal or vertical positions • Chrome plated brass push-button release, base housing, and concealed "T" mount bracket • Stainless steel fixings supplied • Tested by ANTL (test report 4699.11-12/12/2017) <div style="display: flex; align-items: center;">  <div style="margin-left: 10px;"> <p>A. </p> <p>B. </p> <p><i>Nurse call switch not included</i></p> </div> </div> <p>*Allow 12 weeks for production</p>		
	TL 850 BS RHBL	Brushed Stainless			
	WITH NURSE CALL MOUNT BOX (A)				
	TL 850 BS LHBN*	Brushed Stainless			
	TL 850 BS RHBN*	Brushed Stainless			
	WITH STAINLESS STEEL ROLL HOLDER (B)				
	TL 850 BS LHBS*	Brushed Stainless			
	TL 850 BS RHBS*	Brushed Stainless			
	SWINGLOCK® 850MM SIDE ASSIST RAIL				
		SL 850 BS		Brushed Stainless	<ul style="list-style-type: none"> • 850mm side swing grab rail • Fabricated from 32mm 304 stainless steel • 78mm pre-formed Clam® Flange • Stainless steel fixings supplied • Complies with the general requirements for applications in hospitals, homes for the elderly and nursing homes <div style="display: flex; align-items: center;"> <p>A. </p> <p>B. </p> </div> <p>*Allow 12 weeks for production</p>
WITH NURSE CALL HOOK (A)					
SL 850 BS H*		Brushed Stainless			
WITH TOILET PAPER HOLDER (B)					
SL 850 BS S*		Brushed Stainless			
FLOOR/WALL MOUNTED 800MM GRAB RAIL					
	CF 818 BS	Brushed Stainless	<ul style="list-style-type: none"> • Free standing, floor or wall mounted grab rail • Fabricated from 32mm 304 stainless steel • 78mm pre-formed domed Clam® Flange • Stainless steel fixings supplied 		
LIFT-N-LOCK™ 850MM FOLDING GRAB RAIL					
 <p>Drawn LH (Left Hand)</p>	LL 850 BS	Brushed Stainless	<ul style="list-style-type: none"> • 850mm folding grab rail • Locks in the vertical position • Fabricated from 32mm 304 stainless steel • Suitable for non-compliant applications • Stainless steel fixings supplied <div style="display: flex; align-items: center;">  </div>		

Spare Parts and Accessories

	Code	Finish	Features
GRAB RAIL FLEXIBLE TOILET PAPER HOLDER			
	TR 031 BLC	Black/Chrome	<ul style="list-style-type: none"> • Fastens to 32mm grab rail • ABS construction • Chrome toilet paper holder and lock nut • Easy to position where needed • Simple to clean • Retro Fitted
	TR 031 GYC	Grey/Chrome	
	TR 031 WTC	White/Chrome	
GRAB RAIL STAINLESS STEEL TOILET PAPER HOLDER			
 <p>Stainless Steel</p>	TR 031 BS S	Brushed Stainless	<ul style="list-style-type: none"> • Suits 32mm grab rail • Stainless steel construction • Factory fitted
	TR 031 PS S	Polish Supreme™	
HYGIENIC SEAL® WALL MOUNT PLATE			
	HS 032 B MP	Brass	<ul style="list-style-type: none"> • Mounting plate for Hygienic Seal® grab rails • Enlarged fixing points for fastening adjustment • Brass construction • Stainless steel fixings supplied
HYGIENIC SEAL® STAND OFF PLATE			
	HS 032 PS SP	Polish Supreme™	<ul style="list-style-type: none"> • For installation of Hygienic Seal® grab rails when fixing point extends past tiled surface • Fabricated from 304 stainless steel • Polish Supreme™ finish
SHOWER SEAT WALL MOUNT PLATE			
	HS 032 BS BM	Brushed Stainless	<ul style="list-style-type: none"> • Mount Plates allow for removal and re-fitting of shower seats in accessible compartments • Stainless steel construction • 50mm x 25mm • Stainless steel fixing screws supplied
HYGIENIC SEAL® FLANGE COVER			
	HS 032 AW FC	Antimicrobial White	<ul style="list-style-type: none"> • 50mm Hygienic Seal® flange cover • Brass construction • Chrome plated finish
	HS 032 BS FC	Brushed Stainless	
	HS 032 C FC	Chrome	
	HS 032 MB FC	Matte Black	
HYGIENIC SEAL® BLANK END FLANGE			
	HS 032 C BF	Chrome	<ul style="list-style-type: none"> • Cover for Hygienic Seal® wall mount plates once grab rail has been removed • Tamper resistant • Brass construction • Chrome plated finish
	HS 032 MB BF	Matte Black	

SPARE PARTS AND ACCESSORIES MOUNTING SYSTEMS

Con-Serv has a range of accessories and mounting options suitable for 32mm grab rails. Accessories are available as Factory Fitted (must be installed by Con-Serv) or Retro Fitted (user installed). Mounting systems are compatible exclusively with Hygienic Seal® flanges.

	Code	Finish	Features
HYGIENIC SEAL® SINGLE SIDED FIXING SYSTEM			
	SUITS 10MM - 14MM PARTITIONS		<ul style="list-style-type: none"> For installations requiring a grab rail fastened to a partition Suitable for partitions 10mm - 34mm
	HS 032 C BE10	Chrome	
	SUITS 15MM - 19MM PARTITIONS		
	HS 032 C BE15	Chrome	SINGLE SIDED KITS INCLUDE: <ul style="list-style-type: none"> 2 x HS 032 B MP wall mount plates 2 x HS 032 C BF blank end flanges 4 x Internal thread tubes 8 x M5 x 10mm CSK 304 screws
SUITS 30MM - 34MM PARTITIONS			
HS 032 C BE30	Chrome		
HYGIENIC SEAL® BACK TO BACK FIXING SYSTEM			
	SUITS 10MM - 14MM PARTITIONS		<ul style="list-style-type: none"> For installations requiring back to back fastening of two (2) grab rails separated by a partition Suitable for partitions 10mm - 34mm
	HS 032 B BB10	Chrome	
	SUITS 15MM - 19MM PARTITIONS		
	HS 032 B BB15	Chrome	BACK TO BACK KITS INCLUDE: <ul style="list-style-type: none"> 4 x Internal thread tubes 8 x M5 x 10mm CSK 304 screws
SUITS 30MM - 34MM PARTITIONS			
HS 032 B BB30	Chrome		
HIDEAWAY™ MOUNTING SYSTEM FOR GRAB RAILS			
	HYGIENIC SEAL® MOUNTING PLATE (A)		<ul style="list-style-type: none"> Hygienic Seal® Blank End Flanges (B) are designed to conceal the grab rail wall mount plate (A) in situations where the grab rail needs to be removed To install, unscrew the Hygienic Seal® flange, and cover with the existing wall plate (A) with the blank end flange (B) To ensure a tamper resistant installation, tighten the tamper resistant grub screw with the hex key supplied Brass construction Please note, mounting plates are included with our Hygienic Seal® Grab Rail or Backrest
	HS 032 B MP	Brass	
	BLANK END FLANGE (B)		
	HS 032 C BF	Chrome	
	HS 032 MB BF	Matte Black	
RETROFIT BACKREST KIT (SET OF 4)			
	HS 432 C BF	Chrome	
	HS 432 MB BF	Matte Black	
*Backrest not included.			
HIDEAWAY™ MOUNTING SYSTEM FOR SHOWER SEATS			
	SHOWER SEAT MOUNTING PLATE (A)		<ul style="list-style-type: none"> Compatible with Con-Serv Folding Shower Seats, Hygienic Seal® Blank End Flanges conceal the shower seat mount plates in situations where the seat needs to be removed To install, simply remove the shower seat fixing and cover with the existing wall plate with the blank end flange To ensure a tamper resistant installation, tighten the tamper resistant grub screw with the hex key supplied Brass construction Please note, mounting plates are not included with our Folding Shower Seat
	HS 032 BS BM	Brushed Stainless	
	BLANK END FLANGE (B)		
	HS 032 C BF	Chrome	
	HS 032 MB BF	Matte Black	
RETROFIT SHOWER SEAT KIT (SET OF 4)			
	HS 432 C SF	Chrome	
	HS 432 MB SF	Matte Black	
*Shower and Shower Seat are not included.			

SPARE PARTS AND ACCESSORIES

HOSE RESTRICTOR, SLIDERS AND ACCESSORIES



Con-Serv has a range of shower sliders and accessories suitable for 32mm grab rails. Sliders and accessories are available as Factory Fitted (must be installed by Con-Serv) or Retro Fitted (user installed).

	Code	Finish	Features
HOSE RESTRICTOR BRACKET			
	HR 015 BN	Brushed Nickel	<ul style="list-style-type: none"> • Wall mounted hose restrictor • Brass construction • Ideal for accessible applications with handheld showers in close proximity to the WC. • Dual screw wall mount plate • Stainless steel fixings supplied
	HR 015 C	Chrome	
	HR 015 MB	Matte Black	
GRAB RAIL SOAP DISH HOLDER			
	SD 032 BLC	Black/Chrome	<ul style="list-style-type: none"> • Fastens to 32mm grab rail • ABS construction • Chrome plated lock nut • Simple to clean • Retro fitted
	SD 032 GYC	Grey/Chrome	
	SD 032 WTC	White/Chrome	
GRAB RAIL GLIDE SLIDE HANDSET CRADLE			
	HC 024 AW	Antimicrobial White	<ul style="list-style-type: none"> • Clicklock™ cradle mechanism • Fastens to 32mm grab rail • ABS construction • Chrome handset cradle and lock nut • Simple to clean • Retro fitted
	HC 024 BLC	Black/Chrome	
	HC 024 GYC	Grey/Chrome	
	HC 024 WTC	White/Chrome	
BRASS 32MM FRICTION SLIDE CRADLE			
	HC 932 BN	Brushed Nickel	<ul style="list-style-type: none"> • Suits 32mm grab rail • Pivoting cradle adjustment for handset • Smooth slide action • Self locking • Brass construction • Factory fitted <p style="text-align: right;">ONLY COMPATIBLE WITH CON-SERV GRAB RAILS</p>
	HC 932 C	Chrome	
	HC 932 MB	Matte Black	
FACTORY FITTED			
PUSH-PULLME® SHOWER POSITIONING CRADLE WITH ROD			
	PM 932 C	Chrome	<ul style="list-style-type: none"> • Suits 32mm grab rail • Pivoting cradle adjustment for handset • Height adjustment rod for seated users • Smooth slide action • Self locking • Brass construction • Chrome plated finish • Factory fitted • Complies with AS 1428.1:2021 <p style="text-align: right;">ONLY COMPATIBLE WITH CON-SERV GRAB RAILS</p>
FACTORY FITTED			

SPARE PARTS AND ACCESSORIES

RAILS WITH SLIDERS

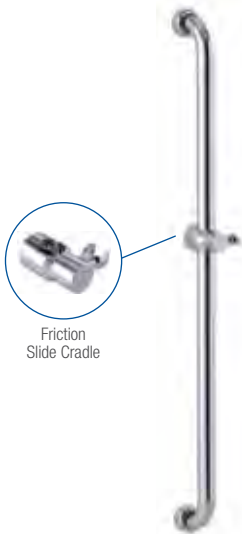
Con-Serv has a range of shower sliders and accessories suitable for 32mm grab rails. Sliders and accessories are available as Factory Fitted (must be installed by Con-Serv) or Retro Fitted (user installed).

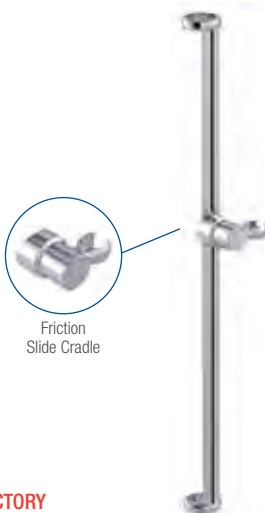
	Code	Finish	Features
HYGIENIC SEAL® 900MM GRAB RAIL WITH FRICTION SLIDE CRADLE			
	HF 932 BS	Brushed Stainless	<ul style="list-style-type: none"> • 900mm, centre to centre • 32mm grab rail • Brass Friction Slide Cradle • Fabricated from 304 stainless steel • Assembled with Hygienic Seal® 50mm brass screw on flange covers with Biomaster Thermoplastic Elastomer (TPE) fitted seals • Stainless steel fixing screws supplied • Meets the requirements of AS 1428.1:2021 Design for access and mobility
	HF 932 C	Chrome	
	HF 932 MB	Matte Black	
LINEAR 900MM GRAB RAIL WITH FRICTION SLIDE CRADLE			
	LF 932 BS	Brushed Stainless	<ul style="list-style-type: none"> • 900mm, centre to centre • 32mm Linear grab rail • Brass Friction Slide Cradle • Fabricated from 304 stainless steel • Assembled with Hygienic Seal® 50mm brass screw on flange covers with Biomaster Thermoplastic Elastomer (TPE) fitted seals • Stainless steel fixing screws supplied • Meets the requirements of AS 1428.1:2021 Design for access and mobility
	LF 932 C	Chrome	
	LF 932 MB	Matte Black	
PREMIUM 700MM FRICTION SLIDE TRACK CRADLE & COLLARS			
	SR 700 C	Chrome	<ul style="list-style-type: none"> • Brass 700mm low profile track • Suits 32mm grab rails • Recommended for persons with weakened wrists, arthritic or grip problems • Recommended for persons with weakened wrists, arthritic or grip problems • Brass friction slide cradle for handset support & height adjustment • Factory fitted <p style="text-align: center; color: red;">ONLY COMPATIBLE WITH CON-SERV GRAB RAILS</p>
	SR 700 MB	Matte Black	
	SR 700 WTC	White/Chrome	
FACTORY FITTED			

- ABS 32mm Glide Slide handset cradle
- DR brass wall outlet elbow
- DR brass 9L/min flow Interchange® spigot

- Licenced dual check/non-return valve
- 57mm solid brass round flat flange
- PVC 1500mm hose



GRAB RAIL NOT INCLUDED

ABS GLIDE SLIDE CRADLE

Model	Code	Finish	Features
STREAMJET™			
	HS 01806J C	Chrome	<ul style="list-style-type: none"> • ABS 100mm single function shower • Concentric full pattern spray • Rub-clean spray diffuser • WaterMark AS 3662 WMKT 21147 • Available in 3 Star 9L/min and 4 Star 6.5L/min as per WELS licence number 0046 
	HS 01806J C/6.5	Chrome	
	HS 01806J WTC	White/Chrome	
	HS 01806J WTC/6.5	White/Chrome	
STREAMJET™ TURBO PULSATOR			
	HS 01806T C	Chrome	<ul style="list-style-type: none"> • ABS 100mm multi-function shower • Soft, pulsating and bubble spray functions • Rub-clean spray diffuser • WaterMark AS 3662 WMKT 21147 • Available in 3 Star 9L/min as per WELS licence number 0046   
STREAMJET™ XL			
	HS 01806X C	Chrome	<ul style="list-style-type: none"> • ABS 130mm single function shower • Concentric full pattern spray • Rub-clean spray diffuser • WaterMark AS 3662 WMKT 21147 • Available in 3 Star 9L/min as per WELS licence number 0046 
STREAMJET™ XL TURBO PULSATOR			
	HS 01806S C	Chrome	<ul style="list-style-type: none"> • ABS 130mm multi-function shower • Soft, pulsating and bubble spray functions • Rub-clean spray diffuser • WaterMark AS 3662 WMKT 21147 • Available in 3 Star 9L/min as per WELS licence number 0046   
HOSCARE®			
	HS 01806 C	Antimicrobial Chrome	<ul style="list-style-type: none"> • ABS 100mm single function shower with Biomaster antimicrobial additive • Concentric full pattern spray • Rub-clean spray diffuser • WaterMark AS 3662 WMKT 21147 • Available in 3 Star 9L/min and 4 Star 6.5L/min as per WELS licence number 0046 
	HS 01806 C/6.5	Antimicrobial Chrome	
	HS 01806 AW	Antimicrobial White	
	HS 01806 AW/6.5	Antimicrobial White	
PRINCESS			
	HS 01806P C	Chrome	<ul style="list-style-type: none"> • ABS 83mm arched single function shower • Full pattern spray • Rub-clean spray diffuser • WaterMark AS 3662 WMKT 21147 • Available in 3 Star 9L/min as per WELS licence number 0046 



Model shown: HS 01806T C

SPARE PARTS AND ACCESSORIES - SHOWER KITS

32MM GLIDE SLIDE & HOSE RESTRICTOR BRACKET

- ABS 32mm Glide Slide handset cradle
- Hose Restrictor Bracket
- DR brass wall outlet elbow
- DR brass 9L/min flow interchange® spigot
- Licenced dual check/non-return valve
- 57mm solid brass round flat flange
- PVC 1500mm hose



Model	Code	Finish	Features
STREAMJET™			
	HS 01810J C	Chrome	<ul style="list-style-type: none"> • ABS 100mm single function shower • Concentric full pattern spray • Rub-clean spray diffuser • WaterMark AS 3662 WMKT 21147 • Available in 3 Star 9L/min and 4 Star 6.5L/min as per WELS licence number 0046 
	HS 01810J C/6.5	Chrome	
	HS 01810J WTC	White/Chrome	
	HS 01810J WTC/6.5	White/Chrome	
STREAMJET™ TURBO PULSATOR			
	HS 01810T C	Chrome	<ul style="list-style-type: none"> • ABS 100mm multi-function shower • Soft, pulsating and bubble spray functions • Rub-clean spray diffuser • WaterMark AS 3662 WMKT 21147 • Available in 3 Star 9L/min as per WELS licence number 0046 
STREAMJET™ XL			
	HS 01810X C	Chrome	<ul style="list-style-type: none"> • ABS 130mm single function shower • Concentric full pattern spray • Rub-clean spray diffuser • WaterMark AS 3662 WMKT 21147 • Available in 3 Star 9L/min as per WELS licence number 0046 
STREAMJET™ XL TURBO PULSATOR			
	HS 01810S C	Chrome	<ul style="list-style-type: none"> • ABS 130mm multi-function shower • Soft, pulsating and bubble spray functions • Rub-clean spray diffuser • WaterMark AS 3662 WMKT 21147 • Available in 3 Star 9L/min as per WELS licence number 0046 
HOSCARE®			
	HS 01810 C	Antimicrobial Chrome	<ul style="list-style-type: none"> • ABS 100mm single function shower with Biomaster antimicrobial additive • Concentric full pattern spray • Rub-clean spray diffuser • WaterMark AS 3662 WMKT 21147 • Available in 3 Star 9L/min and 4 Star 6.5L/min as per WELS licence number 0046 
	HS 01810 C/6.5	Antimicrobial Chrome	
PRINCESS			
	HS 01810P C	Chrome	<ul style="list-style-type: none"> • ABS 83mm arched single function shower • Full pattern spray • Rub-clean spray diffuser • WaterMark AS 3662 WMKT 21147 • Available in 3 Star 9L/min as per WELS licence number 0046 



Model shown: HS 01810T C

- 32mm Friction Slide handset cradle
- DR brass wall outlet elbow
- DR brass 9L/min flow Interchange® spigot
- Licenced dual check/non-return valve
- 57mm solid brass round flat flange
- PVC 1500mm hose



GRAB RAIL NOT INCLUDED



FRICTION SLIDE CRADLE

ONLY COMPATIBLE WITH CON-SERV GRAB RAILS



Model	Code	Finish	Features	
STREAMJET™				
	HS 01804J BN	Brushed Nickel	<ul style="list-style-type: none"> • ABS 100mm single function shower • Concentric full pattern spray • Rub-clean spray diffuser • WaterMark AS 3662 WMKT 21147 • Available in 3 Star 9L/min and 4 Star 6.5L/min as per WELS licence number 0046 	
	HS 01804J BN/6.5	Brushed Nickel		
	HS 01804J C	Chrome		
	HS 01804J C/6.5	Chrome		
	HS 01804J MB	Matte Black		
	HS 01804J MB/6.5	Matte Black		
STREAMJET™ TURBO PULSATOR				
	HS 01804T C	Chrome	<ul style="list-style-type: none"> • ABS 100mm multi-function shower • Soft, pulsating and bubble spray functions • Rub-clean spray diffuser • WaterMark AS 3662 WMKT 21147 • Available in 3 Star 9L/min as per WELS licence number 0046 	
STREAMJET™ XL				
	HS 01804X BN	Brushed Nickel	<ul style="list-style-type: none"> • ABS 130mm single function shower • Concentric full pattern spray • Rub-clean spray diffuser • WaterMark AS 3662 WMKT 21147 • Available in 3 Star 9L/min as per WELS licence number 0046 	
	HS 01804X C	Chrome		
	HS 01804X MB	Matte Black		
STREAMJET™ XL TURBO PULSATOR				
	HS 01804S C	Chrome	<ul style="list-style-type: none"> • ABS 130mm multi-function shower • Soft, pulsating and bubble spray functions • Rub-clean spray diffuser • WaterMark AS 3662 WMKT 21147 • Available in 3 Star 9L/min as per WELS licence number 0046 	
HOSCARE®				
	HS 01804 C	Antimicrobial Chrome	<ul style="list-style-type: none"> • ABS 100mm single function shower with Biomaster antimicrobial additive • Concentric full pattern spray • Rub-clean spray diffuser • WaterMark AS 3662 WMKT 21147 • Available in 3 Star 9L/min and 4 Star 6.5L/min as per WELS licence number 0046 	
	HS 01804 C/6.5	Antimicrobial Chrome		
PRINCESS				
	HS 01804P C	Chrome	<ul style="list-style-type: none"> • ABS 83mm arched single function shower • Full pattern spray • Rub-clean spray diffuser • WaterMark AS 3662 WMKT 21147 • Available in 3 Star 9L/min as per WELS licence number 0046 	



Model shown: HS 01804P C

SPARE PARTS AND ACCESSORIES - SHOWER KITS

32MM FRICTION SLIDER & HOSE RESTRICTOR BRACKET

- 32mm Friction Slide handset cradle
- Hose Restrictor Bracket
- DR brass wall outlet elbow
- DR brass 9L/min flow interchange® spigot
- Licenced dual check/non-return valve
- 57mm solid brass round flat flange
- PVC 1500mm hose

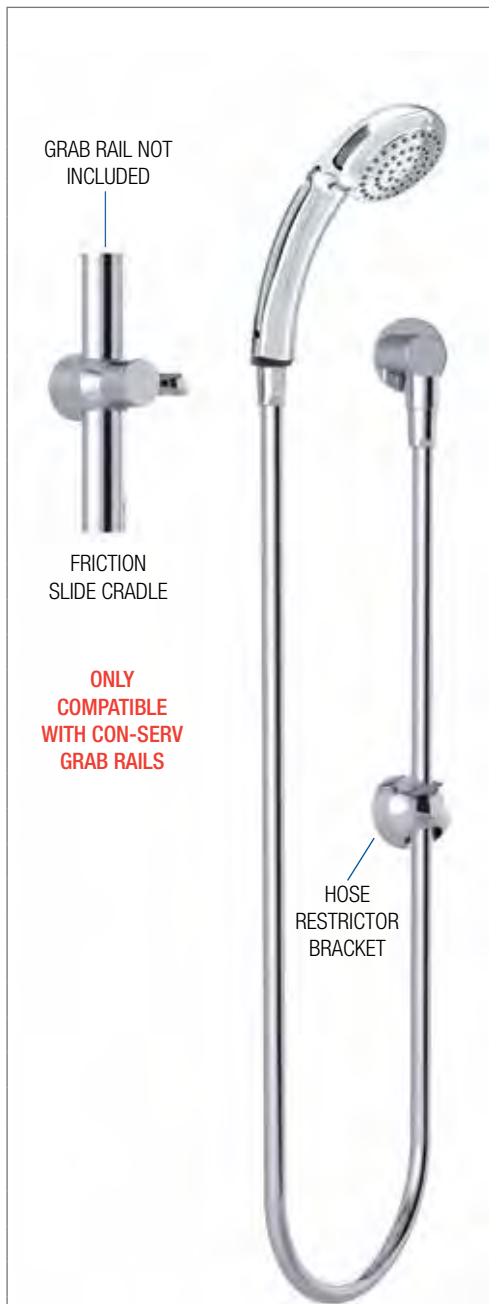

Model	Code	Finish	Features
STREAMJET™			
	HS 01808J BN	Brushed Nickel	<ul style="list-style-type: none"> • ABS 100mm single function shower • Concentric full pattern spray • Rub-clean spray diffuser • WaterMark AS 3662 WMKT 21147 • Available in 3 Star 9L/min and 4 Star 6.5L/min as per WELS licence number 0046 
	HS 01808J BN/6.5	Brushed Nickel	
	HS 01808J C	Chrome	
	HS 01808J C/6.5	Chrome	
	HS 01808J MB	Matte Black	
	HS 01808J MB/6.5	Matte Black	
STREAMJET™ TURBO PULSATOR			
	HS 01808T C	Chrome	<ul style="list-style-type: none"> • ABS 100mm multi-function shower • Soft, pulsating and bubble spray functions • Rub-clean spray diffuser • WaterMark AS 3662 WMKT 21147 • Available in 3 Star 9L/min as per WELS licence number 0046 
STREAMJET™ XL			
	HS 01808X BN	Brushed Nickel	<ul style="list-style-type: none"> • ABS 130mm single function shower • Concentric full pattern spray • Rub-clean spray diffuser • WaterMark AS 3662 WMKT 21147 • Available in 3 Star 9L/min as per WELS licence number 0046 
	HS 01808X C	Chrome	
	HS 01808X MB	Matte Black	
STREAMJET™ XL TURBO PULSATOR			
	HS 01808S C	Chrome	<ul style="list-style-type: none"> • ABS 130mm multi-function shower • Soft, pulsating and bubble spray functions • Rub-clean spray diffuser • WaterMark AS 3662 WMKT 21147 • Available in 3 Star 9L/min as per WELS licence number 0046 
HOSCARE®			
	HS 01808 C	Antimicrobial Chrome	<ul style="list-style-type: none"> • ABS 100mm single function shower with Biomaster antimicrobial additive • Concentric full pattern spray • Rub-clean spray diffuser • WaterMark AS 3662 WMKT 21147 • Available in 3 Star 9L/min and 4 Star 6.5L/min as per WELS licence number 0046 
	HS 01808 C/6.5	Antimicrobial Chrome	
PRINCESS			
	HS 01808P C	Chrome	<ul style="list-style-type: none"> • ABS 83mm arched single function shower • Full pattern spray • Rub-clean spray diffuser • WaterMark AS 3662 WMKT 21147 • Available in 3 Star 9L/min as per WELS licence number 0046 















Model shown: HS 01808P C

SPARE PARTS AND ACCESSORIES - SHOWER KITS

32MM PUSH-PULLME® CRADLE WITH ROD

- 32mm Push-PullMe® cradle with rod
- DR brass wall outlet elbow
- DR brass 9L/min flow Interchange® spigot
- Licenced dual check/non-return valve
- 57mm solid brass round flat flange
- PVC 1500mm hose

Model	Code	Finish	Features
STREAMJET™			
	ID 01804J C	Chrome	<ul style="list-style-type: none"> • ABS 100mm single function shower • Concentric full pattern spray • Rub-clean spray diffuser • WaterMark AS 3662 WMKT 21147 • Available in 3 Star 9L/min and 4 Star 6.5L/min as per WELS licence number 0046 
	ID 01804J C/6.5	Chrome	
STREAMJET™ TURBO PULSATOR			
	ID 01804T C	Chrome	<ul style="list-style-type: none"> • ABS 100mm multi-function shower • Soft, pulsating and bubble spray functions • Rub-clean spray diffuser • WaterMark AS 3662 WMKT 21147 • Available in 3 Star 9L/min as per WELS licence number 0046 
STREAMJET™ XL			
	ID 01804X C	Chrome	<ul style="list-style-type: none"> • ABS 130mm single function shower • Concentric full pattern spray • Rub-clean spray diffuser • WaterMark AS 3662 WMKT 21147 • Available in 3 Star 9L/min as per WELS licence number 0046 
STREAMJET™ XL TURBO PULSATOR			
	ID 01804S C	Chrome	<ul style="list-style-type: none"> • ABS 130mm multi-function shower • Soft, pulsating and bubble spray functions • Rub-clean spray diffuser • WaterMark AS 3662 WMKT 21147 • Available in 3 Star 9L/min as per WELS licence number 0046 
HOSCARE®			
	ID 01804 C	Antimicrobial Chrome	<ul style="list-style-type: none"> • ABS 100mm single function shower with Biomaster antimicrobial additive • Concentric full pattern spray • Rub-clean spray diffuser • WaterMark AS 3662 WMKT 21147 • Available in 3 Star 9L/min and 4 Star 6.5L/min as per WELS licence number 0046 
	ID 01804 C/6.5	Antimicrobial Chrome	
PRINCESS			
	ID 01804P C	Chrome	<ul style="list-style-type: none"> • ABS 83mm arched single function shower • Full pattern spray • Rub-clean spray diffuser • WaterMark AS 3662 WMKT 21147 • Available in 3 Star 9L/min as per WELS licence number 0046 

GRAB RAIL NOT INCLUDED



PUSH-PULLME®
CRADLE
WITH ROD

**KIT ONLY
COMPATIBLE
WITH CON-SERV
GRAB RAILS**



Model shown: ID 01804P C

SPARE PARTS AND ACCESSORIES - SHOWER KITS

32MM PUSH-PULLME® & HOSE RESTRICTOR BRACKET

- 32mm Push-PullMe® cradle with rod
- Hose Restrictor Bracket
- DR brass wall outlet elbow
- DR brass 9L/min flow interchange® spigot
- Licenced dual check/non-return valve
- 57mm solid brass round flat flange
- PVC 1500mm hose

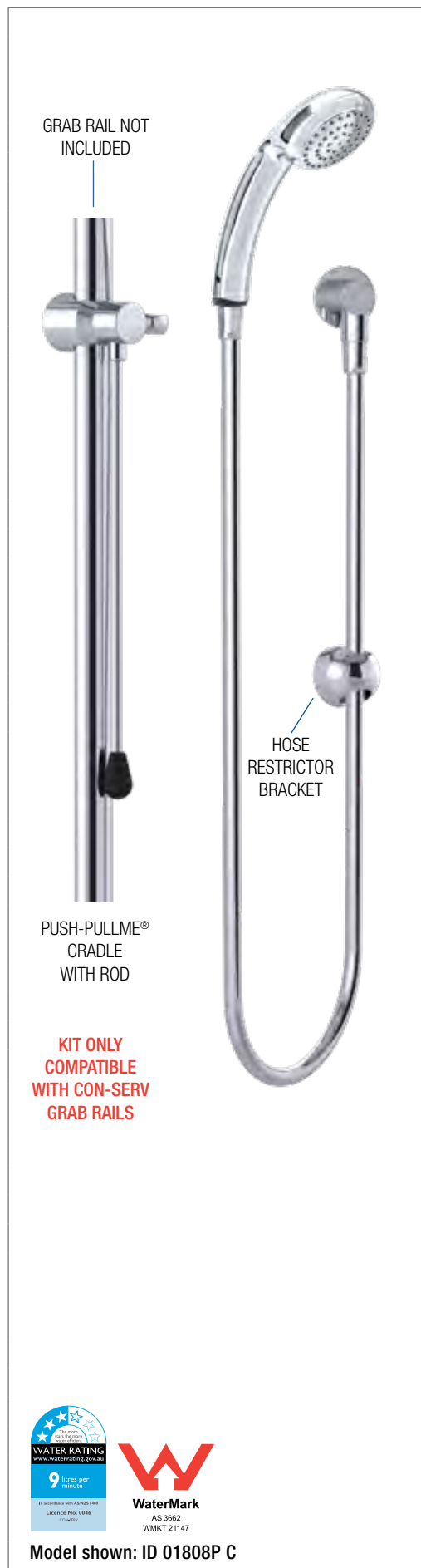

Model	Code	Finish	Features
STREAMJET™			
	ID 01808J C	Chrome	<ul style="list-style-type: none"> • ABS 100mm single function shower • Concentric full pattern spray • Rub-clean spray diffuser • WaterMark AS 3662 WMKT 21147 • Available in 3 Star 9L/min and 4 Star 6.5L/min as per WELS licence number 0046 
	ID 01808J C/6.5	Chrome	
STREAMJET™ TURBO PULSATOR			
	ID 01808T C	Chrome	<ul style="list-style-type: none"> • ABS 100mm multi-function shower • Soft, pulsating and bubble spray functions • Rub-clean spray diffuser • WaterMark AS 3662 WMKT 21147 • Available in 3 Star 9L/min as per WELS licence number 0046 
STREAMJET™ XL			
	ID 01808X C	Chrome	<ul style="list-style-type: none"> • ABS 130mm single function shower • Concentric full pattern spray • Rub-clean spray diffuser • WaterMark AS 3662 WMKT 21147 • Available in 3 Star 9L/min as per WELS licence number 0046 
STREAMJET™ XL TURBO PULSATOR			
	ID 01808S C	Chrome	<ul style="list-style-type: none"> • ABS 130mm multi-function shower • Soft, pulsating and bubble spray functions • Rub-clean spray diffuser • WaterMark AS 3662 WMKT 21147 • Available in 3 Star 9L/min as per WELS licence number 0046 
HOSCAR®			
	ID 01808 C	Antimicrobial Chrome	<ul style="list-style-type: none"> • ABS 100mm single function shower with Biomaster antimicrobial additive • Concentric full pattern spray • Rub-clean spray diffuser • WaterMark AS 3662 WMKT 21147 • Available in 3 Star 9L/min and 4 Star 6.5L/min as per WELS licence number 0046 
	ID 01808 C/6.5	Antimicrobial Chrome	
PRINCESS			
	ID 01808P C	Chrome	<ul style="list-style-type: none"> • ABS 83mm arched single function shower • Full pattern spray • Rub-clean spray diffuser • WaterMark AS 3662 WMKT 21147 • Available in 3 Star 9L/min as per WELS licence number 0046 



Model shown: ID 01808P C

AS 1428.1:2021 - SECTION 12 ACCESSIBLE SANITARY FACILITIES

Con-Serv have developed a collection of AS 1428.1:2021 Kits that meet the needs for Accessible Sanitary Facilities, Accessible Shower Recess, Accessible Combined Sanitary Facilities (Section 12) and Ambulant Accessible Sanitary Compartments (Section 13).



	Code	Finish	Features
ACCESSIBLE SANITARY FACILITIES COMBINATION SET: OPTION A FOR USE WITH EXPOSED CISTERNS			
	CLAM® FLANGE		<ul style="list-style-type: none"> Grab rails meet the requirements of AS 1428.1:2021 Design for access and mobility, when installed correction TPE seals with Biomaster antimicrobial additive All dimensions \emptyset to \emptyset distances Wall clearance 55mm Stainless steel fixing screws supplied
	AC 877 BS CF LH	Brushed Stainless	
	AC 877 BS CF RH	Brushed Stainless	
	AC 877 PS CF LH	Polish Supreme™	
	AC 877 PS CF RH	Polish Supreme™	
	HYGIENIC SEAL®		COMBINATION SET INCLUDES: A. 870mm x 700mm grab rail B. Toilet paper holder C. Wall mount backrest D. 300mm grab rail
	AC 877 BS HS LH	Brushed Stainless	
	AC 877 BS HS RH	Brushed Stainless	
	AC 877 MB HS LH	Matte Black	
	AC 877 MB HS RH	Matte Black	
AC 877 PS HS LH	Polish Supreme™		
AC 877 PS HS RH	Polish Supreme™		
	LINEAR		<p>Top of grab rail 800mm to 820mm above the finished floor. Drawn RH (Right Hand)</p>
	AC 877 BS LR LH	Brushed Stainless	
	AC 877 BS LR RH	Brushed Stainless	
	AC 877 MB LR LH	Matte Black	
	AC 877 MB LR RH	Matte Black	
	AC 877 PS LR LH	Polish Supreme™	
	AC 877 PS LR RH	Polish Supreme™	



Other Colours P.O.A.

AS 1428.1:2021 Updates

The AS 1428.1 is a building standard for Design for access and mobility prepared by the Australian Standards Committee. In June, 2021 a revised Standard was released. As a specialist in the manufacture and supply of healthcare bathroom fittings, we have summarised relevant updates where Con-Serv have a solution to assist in meeting the new requirements.

Backrest: Section 12.2.4 (g)

In the revised standard, section 12.2.4 (g) states "The backrest shall – in an accessible sole-occupancy unit, be capable of being removed and refitted."

This will apply to any accessible WC in a residential type setting such as a Class B or a 1B group home, boarding houses, hotels, motels or a Class 9C Aged Care facility that require an accessible sole occupancy unit.

To fulfil this requirement, Con-Serv has developed the Hideaway™ Mounting System allowing for our backrests to be removed, stored, and then re-installed when required.

The Hideaway™ Mounting System comprises of Blank End Flanges that utilise the same wall mount plates to install Hygienic Seal® grab rails. The installer simply removes the grab rail, leaving the wall mount plate in place, and covering with the blank end flange until it's needed again. Visit Hideaway™ Mounting System for more information.

Showers: Section 12.5.1

The previous shower connection measurement has now been changed to a connection zone. The hose connection is permitted within a larger zone measuring 700mm to 1100mm above the finished floor level and 100mm to 800mm from the corner of the wall ensuring the location does not interfere with the use of grab rails, taps, soap holder or shower seat.

Backflow prevention device and restrictor device: Section 12.5.11 (Backflow Prevention)

Section 12.5.11 states that "unless the shower hose has a restrictor device preventing the shower head from resting on the floor or into the basin, a backflow prevention device will be required to prevent water contamination."

To meet this requirement, all Con-Serv handheld showers are fitted as standard with dual check/non-return valves providing effective backflow prevention against water contamination for low hazard areas. All Con-Serv dual check/non-return valves are licenced as per Watermark AS/NZS 2845.1 WMKA 02696.

Backflow prevention device and restrictor device: Section 12.5.11 (Restrictor Device)

Section 12.5.11 advises that "where it would be possible for the shower head to reach into the toilet pan then a restrictor device shall be fitted to prevent the hose reaching the toilet"; and that the "restrictor device shall be a proprietary item which restricts the movement of the shower hose and prevents the shower head from reaching into the toilet pan".

Con-Serv's Hose Restrictor Bracket is an easy to install, cost-effective solution that meets the requirements as outlined in AS 1428.1:2021.

The position of the Hose Restrictor Bracket is dependent on the proximity of the shower to the toilet pan. To install, simply position the bracket on the wall (with the hose inserted) and move until the handpiece no longer reaches the toilet pan. Once the location for installation has been determined, fix the Hose Restrictor Bracket to the wall.

Sanitary compartment for people with ambulant disabilities: Section 13.2

Section 13.2 has been updated stating "Grabrails shall be continuous and consist of a horizontal section plus either a vertical section or an upward angled section".

In reference to this section, the upward angled section has changed from a measurement of 700mm minimum, to a measurement of 400mm to 450mm with an angle of either 30° to 45° (upward angled section) or 90° (vertical section).

To meet this requirement, Con-Serv recommend installing ambulant grab rails that are 450mm x 450mm with a 40° bend; or 450mm x 450mm with a 90° bend.

Con-Serv's HS 045 (40° bend) and HS 454 (90° bend) ambulant grab rails meet this requirement.

For more information, visit saiglobal.com to purchase a copy of the revised standard AS 1428.1:2021 DESIGN FOR ACCESS AND MOBILITY GENERAL REQUIREMENTS FOR ACCESS — NEW BUILDING WORK STANDARD.



Biomaster antimicrobial seals for added protection against bacteria

Toilet assist grab rails in this section comply strictly with the minimum design, strength and dimension requirements of AS 1428.1:2021. Mount horizontal section of grab rail 800mm to 820mm above floor level.

ACCESSIBLE SANITARY FACILITIES COMBINATION SET: OPTION B FOR USE WITH EXPOSED CISTERNS



CLAM® FLANGE	
AC 966 BS CF LH	Brushed Stainless
AC 966 BS CF RH	Brushed Stainless
AC 966 PS CF LH	Polish Supreme™
AC 966 PS CF RH	Polish Supreme™

HYGIENIC SEAL®	
AC 966 BS HS LH	Brushed Stainless
AC 966 BS HS RH	Brushed Stainless
AC 966 MB HS LH	Matte Black
AC 966 MB HS RH	Matte Black
AC 966 PS HS LH	Polish Supreme™
AC 966 PS HS RH	Polish Supreme™

- Grab rails meet the requirements of AS 1428.1:2021 Design for access and mobility, when installed correction
- TPE seals with Biomaster antimicrobial additive
- All dimensions Ø to Ø distances
- Wall clearance 55mm
- Stainless steel fixing screws supplied

COMBINATION SET INCLUDES:
A. 870mm x 700mm grab rail
B. Toilet paper holder
C. Wall mount backrest
D. 300mm grab rail



Other Colours P.O.A.

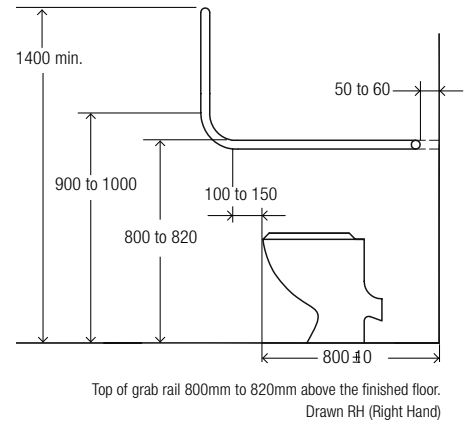

Hygienic Seal®, Drawn RH (Right Hand)

ACCESSIBLE SANITARY FACILITIES COMBINATION SET: OPTION C FOR USE WITH CONCEALED CISTERNS

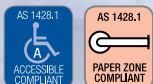

CLAM® FLANGE	
AC 116 BS CF LH	Brushed Stainless
AC 116 BS CF RH	Brushed Stainless
AC 116 PS CF LH	Polish Supreme™
AC 116 PS CF RH	Polish Supreme™

HYGIENIC SEAL®	
AC 116 BS HS LH	Brushed Stainless
AC 116 BS HS RH	Brushed Stainless
AC 116 MB HS LH	Matte Black
AC 116 MB HS RH	Matte Black
AC 116 PS HS LH	Polish Supreme™
AC 116 PS HS RH	Polish Supreme™

- Grab rails meet the requirements of AS 1428.1:2021 Design for access and mobility, when installed correction
- TPE seals with Biomaster antimicrobial additive
- All dimensions Ø to Ø distances
- Wall clearance 55mm
- Stainless steel fixing screws supplied

COMBINATION SET INCLUDES:
A. 1110mm x 1030mm x 600mm grab rail
B. Toilet paper holder
C. Wall mount backrest



Other Colours P.O.A.

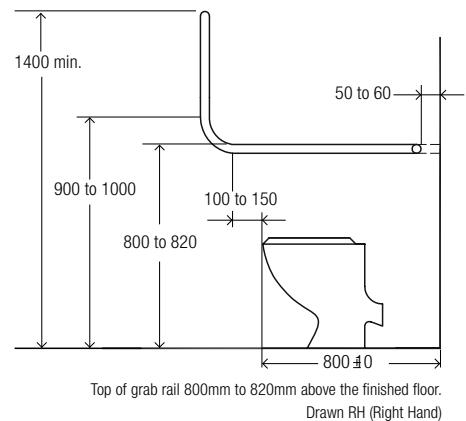

Hygienic Seal®, Drawn RH (Right Hand)

Shower recess grab rails and shower seats in this section comply strictly with the minimum design, strength and dimension requirements of AS 1428.1:2021. Hose Restrictor Bracket to be located such that it prevents the shower head from reaching into the toilet.

	Code	Finish	Features
ACCESSIBLE SHOWER RECESS COMBINATION SET: OPTION A			
	CLAM® FLANGE		<ul style="list-style-type: none"> Grab rails meet the requirements of AS 1428.1:2021 Design for access and mobility, when installed correction TPE Seals with Biomaster antimicrobial additive Hoscare® handpiece with Biomaster antimicrobial additive Available in 3 Star 9L/min and 4 Star 6.5L/min as per WELS licence number 0046 All dimensions Ø to Ø distances Wall clearance 55mm Shower seat load rated to 250kg when correctly installed Stainless steel fixing screws supplied <p>COMBINATION SETS INCLUDES:</p> <p>A. 700mm x 1100mm grab rail featuring Push-PullMe® Shower Positioning Cradle with height adjustment rod for seated users, and handheld shower</p> <p>B. Double robe hook</p> <p>C. 960mm x 400mm shower seat</p> <p> AS 1428.1 ACCESSIBLE COMPLIANT</p> <p>Options available on request</p> <ul style="list-style-type: none"> Hose Restrictor Bracket for applications where it would be possible for the shower head to reach into the toilet pan as per Section 12.5.11 of AS 1428.1:2021 - see page 94 <p>Hose Restrictor Bracket</p> <p>LH & RH grab rail models meet the requirements of AS 1428.1:2021 Design for access and mobility</p>
	AS 01820 BS CF LH	Brushed Stainless	
	AS 01820 BS CF LH/6.5	Brushed Stainless	
	AS 01820 BS CF RH	Brushed Stainless	
	AS 01820 BS CF RH/6.5	Brushed Stainless	
	AS 01820 PS CF LH	Polish Supreme™	
	AS 01820 PS CF LH/6.5	Polish Supreme™	
	AS 01820 PS CF RH	Polish Supreme™	
	AS 01820 PS CF RH/6.5	Polish Supreme™	
	HYGIENIC SEAL®		
	AS 01820 BS HS LH	Brushed Stainless	
	AS 01820 BS HS/6.5 LH	Brushed Stainless	
AS 01820 BS HS RH	Brushed Stainless		
AS 01820 BS HS/6.5 RH	Brushed Stainless		
AS 01820 PS HS LH	Polish Supreme™		
AS 01820 PS HS/6.5 LH	Polish Supreme™		
AS 01820 PS HS RH	Polish Supreme™		
AS 01820 PS HS/6.5 RH	Polish Supreme™		

Hygienic Seal®, Drawn RH (Right Hand)

FRONT ELEVATION

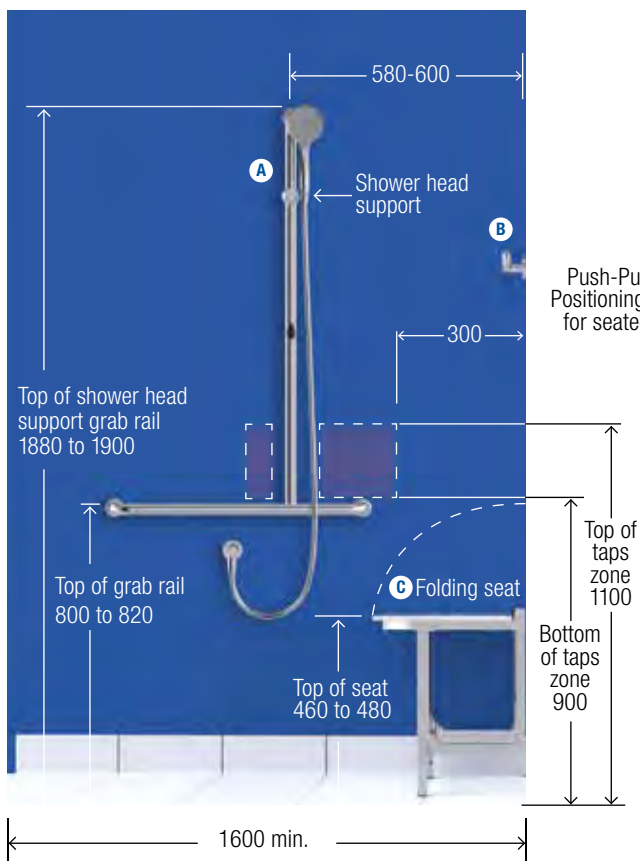

SIDE ELEVATION

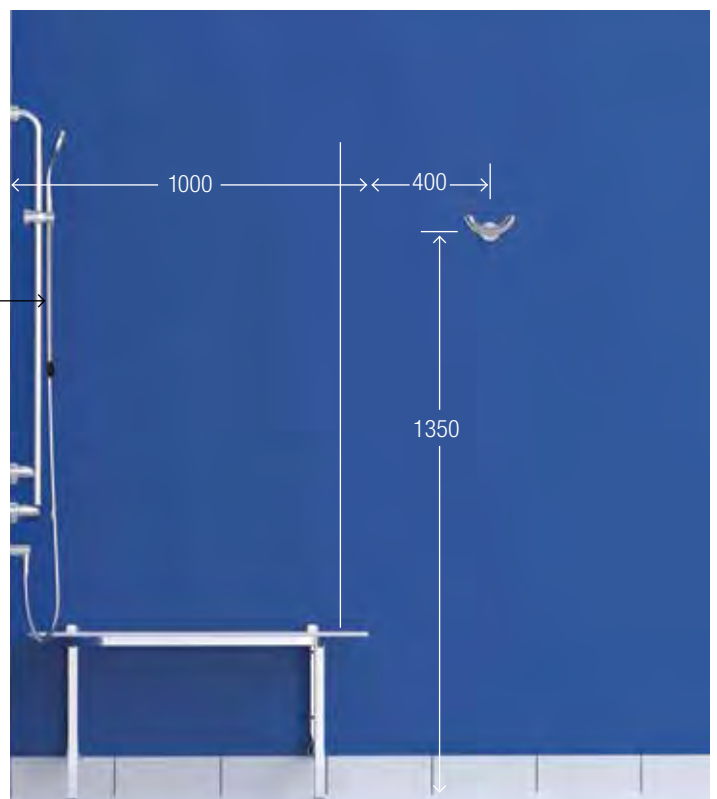

Shower recess grab rails and shower seats in this section comply strictly with the minimum design, strength and dimension requirements of AS 1428.1:2021. Hose Restrictor Bracket to be located such that it prevents the shower head from reaching into the toilet.

	Code	Finish	Features
ACCESSIBLE SHOWER RECESS COMBINATION SET: OPTION B			
	CLAM® FLANGE		<ul style="list-style-type: none"> Grab rails meet the requirements of AS 1428.1:2021 Design for access and mobility, when installed correction TPE Seals with Biomaster antimicrobial additive Hoscare® handpiece with Biomaster antimicrobial additive Available in 3 Star 9L/min and 4 Star 6.5L/min as per WELS licence number 0046 All dimensions Ø to Ø distances Wall clearance 55mm Shower seat load rated to 250kg when correctly installed Stainless steel fixing screws supplied
	AS 01803 BS CF	Brushed Stainless	
	AS 01803 BS CF/6.5	Brushed Stainless	
	AS 01803 PS CF	Polish Supreme™	
	AS 01803 PS CF/6.5	Polish Supreme™	
	HYGIENIC SEAL®		
	AS 01803 BS HS	Brushed Stainless	
	AS 01803 BS HS/6.5	Brushed Stainless	
	AS 01803 PS HS	Polish Supreme™	
	AS 01803 PS HS/6.5	Polish Supreme™	
Hygienic Seal®, Drawn RH (Right Hand)			

FRONT ELEVATION

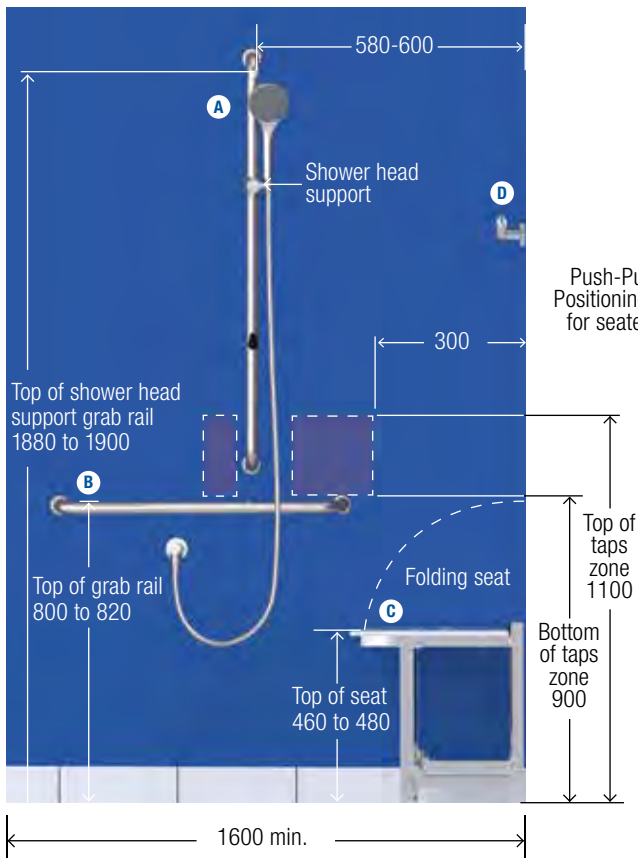

SIDE ELEVATION

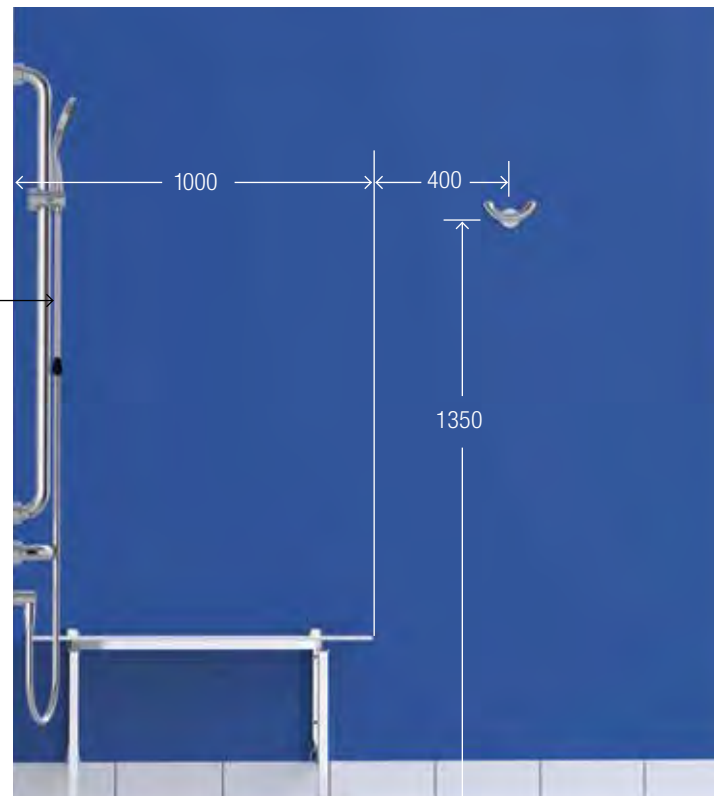

All dimensions are in millimetres unless otherwise specified.

Shower recess grab rails and shower seats in this section comply strictly with the minimum design, strength and dimension requirements of AS 1428.1:2021. For Accessible Sole-Occupancy Units, the Backrest shall be capable of being removed and refitted.



Code Finish Features

ACCESSIBLE COMBINED SANITARY FACILITIES		
	CLAM® FLANGE	
	CS 01820 BS CF LH	Brushed Stainless
	CS 01820 BS CF LH/6.5	Brushed Stainless
	CS 01820 BS CF RH	Brushed Stainless
	CS 01820 BS CF RH/6.5	Brushed Stainless
	CS 01820 PS CF LH	Polish Supreme™
	CS 01820 PS CF LH/6.5	Polish Supreme™
	CS 01820 PS CF RH	Polish Supreme™
	CS 01820 PS CF RH/6.5	Polish Supreme™
	HYGIENIC SEAL®	
CS 01820 BS HS LH	Brushed Stainless	
CS 01820 BS HS LH/6.5	Brushed Stainless	
CS 01820 BS HS RH	Brushed Stainless	
CS 01820 BS HS RH/6.5	Brushed Stainless	
CS 01820 PS HS LH	Polish Supreme™	
CS 01820 PS HS LH/6.5	Polish Supreme™	
CS 01820 PS HS RH	Polish Supreme™	
CS 01820 PS HS RH/6.5	Polish Supreme™	
<p>COMBINATION SET INCLUDES: A. Double robe hook B. 700mm x 1100mm grab rail featuring Push-PullMe® Shower Positioning Cradle with height adjustment rod for seated users, and handheld shower C. 960mm x 400mm shower seat D. Backrest with extension E. 960mm x 600mm grab rail F. Toilet paper holder G. 350mm x 135mm stainless steel shelf Within circulation space</p>		
<p>Options available on request</p> <ul style="list-style-type: none"> Hose Restrictor Bracket for applications where it would be possible for the shower head to reach into the toilet pan as per Section 12.5.1 of AS 1428.1:2021 - see page 107 		
<p>LH & RH grab rail models meet the requirements of AS 1428.1:2021 Design for access and mobility</p>		

Hygienic Seal®, Drawn LH (Left Hand)



Shower recess grab rails and shower seats in this section comply strictly with the minimum design, strength and dimension requirements of AS 1428.1:2021. For Accessible Sole-Occupancy Units, the Backrest shall be capable of being removed and refitted.

	Code	Finish	Features
HOSE RESTRICTOR (A)			
 <p>Hose not included.</p>	HR 015 BN	Brushed Nickel	<ul style="list-style-type: none"> • Wall mounted hose restrictor • Brass construction • Ideal for accessible applications with handheld showers in close proximity to the WC. • Dual screw wall mount plate • Stainless steel fixings supplied
	HR 015 C	Chrome	
	HR 015 MB	Matte Black	
HIDEAWAY™ MOUNTING SYSTEM FOR GRAB RAILS			
	RETROFIT BACKREST KIT - SET OF 4 (B)		<ul style="list-style-type: none"> • Hygienic Seal® Blank End Flanges are designed to conceal the grab rail wall mount plate in situations where the grab rail needs to be removed • To install, simply unscrew the Hygienic Seal® flange, and cover with the existing wall plate with the blank end flange • To ensure a tamper resistant installation, tighten the tamper resistant grub screw with the hex key supplied • Brass construction • Please note, mounting plates are included with our Hygienic Seal® Grab Rail or Backrest
	HS 432 C BF	Chrome	
	HS 432 MB BF	Matte Black	
	HYGIENIC SEAL® MOUNTING PLATE (C)		
	HS 032 B MP	Brass	
	BLANK END FLANGE (D)		
	HS 032 C BF	Chrome	
	HS 032 MB BF	Matte Black	
COMFORT STAINLESS STEEL SHELF 350MM			
 <p>Rounded Safety Edge</p>	BA 710 BS	Brushed Stainless	<ul style="list-style-type: none"> • 350mm, centre to centre • Stainless steel construction • Meets the requirements of Section 12.4.2 (B1) Shelves, within circulation space of AS 1428.1:2021
	BA 710 MB	Matte Black	
	BA 710 PS	Polish Supreme™	
			





Technical Information

The process of building or renovating can be challenging and Con-Serv is committed to providing you with the right information to make the right choice for your next project. Throughout this Product Manual, we have included some general technical information about our range and encourage you to visit our website to explore our online resources for more information.

Specifications Sheets

Where possible, we have included line drawings, product measurements and listed features and benefits of each product represented in our 2022 Product Manual. However, if you need more information, Specifications Sheets are available to download on each product page on our website.

All Specifications Sheets will include:

- Product Code
- Product Image
- Product dimension files (line drawings with measurements)
- Features of the product
- Any relevant Compliance information, Test Report Numbers, Certifications and Licencing information.



Con-Serv website

Need more information about a product or range?

Visit the Con-Serv website to view our complete range and access specification sheets, brochures, fact sheets, installation instructions, news articles and the latest updates on our range.

www.con-serv.com.au



TECHNICAL INFORMATION

Care and Maintenance	111
Index	112
Notes.....	120
Certification and Licencing	123

Care & Maintenance



Con-Serv products offer intrinsic quality born of over 40 years' experience in water efficiency and quality design. Skills combined with innovative techniques and leading designs establish the enduring character for which Con-Serv is known. There is no substitute for the reliable performance or the authentic beauty of our lustre finishes that are resistant to scratching, corrosion and tarnishing. All Con-Serv products are designed and manufactured to the highest standard and cared for correctly will ensure a lifetime of use.

WE OFFER THE FOLLOWING RECOMMENDATIONS

Bathroom Products

- Always use mild detergent soapy water or clear liquid cleansers. Wipe dry any soapy residue with a clean soft cloth.
- Do not use harsh abrasive cleansers as they contain cutting compounds which will scratch our lustrous surfaces.
- Avoid hydrochloric acid as it will lead to tarnishing and pitting. Ensure your tiler rinses clean all products and surfaces if used. Surface damage caused by acids will void warranty.
- Calcium and lime deposits can be treated with a diluted solution of CLR. Follow manufacturers recommendations for safety purposes.
- Maximum operating pressure of 500 kPa
- Maximum operating temperature of 60°C

Cleaning Stainless Steel

To have an optimum corrosion resistant stainless steel, surfaces must be clean and have an adequate supply of oxygen to maintain their "passive" surface layer. Passive film is invisible and is created when oxygen combines with chromium in the stainless steel to form chromium oxide.

Generally, stains and discolouration corrosion occurs when there is an overall breakdown of the passive film, due to incorrect cleaning.

We recommend the following cleaning practises to ensure a lifetime of use for your stainless steel products.

- Alkali cleaners such as baking soda or ammonia are most effective. Always attempt the mildest cleaning method first.
- Stainless steel's best friends are quite simply soap, mild detergent or ammonia solution in warm water applied with a soft cloth or nylon sponge for polished finishes followed by a clean water rinse.
- Dry wipe eliminates the possibility of water stains. Occasionally, the use of the least coarse nylon scouring pad may be required for brush finishes.

What to avoid

- Do not use ordinary steel wool. Iron particles can become embedded in stainless steel and cause 'iron' contamination.
- Do not use chlorides or acids as they are reactive to stainless steel.
- Strong acid solutions like hydrochloric acid or "spirit of salts" are sometimes used to clean masonry and tiling of new bathrooms and toilets, but they should never be permitted to come into contact with metals, including stainless steel.

Halogen salts, especially chlorides, easily penetrate the "passive film" of stainless steel and will allow corrosive attack to occur.

The halogens are easy to recognise because they end in the letters "INE". Listed in order of their activity are:

- Fluorine
- Chlorine
- Bromine
- Iodine
- Astatine

- Never use brick cleaning liquids which contain hydrochloric acid. Many cleaning solutions and solvents contain chlorinated hydro carbons. If a cleaner containing chlorides, bleaches and hypochlorite's are used, it must be promptly and thoroughly cleaned off.
- Please note: The Con-Serv warranty on grab rails will be null and void should they be exposed to chemical corrosion due to incompetent cleaning practices.
- The Con-Serv Hygienic Seal® flange cover has a 5° radius to comply with AS 1428.1:2021. Be most cautious of claims made by imitators.

Caring for your Matte Black bathroom fittings

- The best cleaner for your Matte Black fixtures is warm, soapy water or pH balanced soap-based cleanser, applied with a soft, damp cloth.
- We recommend that you use a clean microfibre cloth. These are readily available, cheap, machine washable, and most importantly won't scratch your matte black surfaces.
- Always wipe your fixtures down after each use to prevent mineral build-up and water spotting.
- Always check the manufacturer's instructions before starting any cleaning regime.

What to avoid

When caring for your matte black shower or grab rail, the surface is a little rough. This means the surface is susceptible to damage if not cared for properly so remember these important don'ts.

- Never use abrasive cleaners, ammoniated products, rubbing alcohol, detergents, astringents, bleached based cleaners, aggressive chemicals, abrasive cleaning pads, or harsh polishes.
- Don't allow soap scum or toothpaste to build upon the product. These will gradually wear away the coating and may diminish the durable finish.

Code A-Z	Description	Page	Code A-Z	Description	Page
AC 116 * CF *	ACCESSIBLE KIT: CLAM FLANGE 1110x1030x600mm	103	AF 5ALF	ANTI-MICROBIAL AERATOR INSERT LAMINAR	42
AC 116 * HS *	ACCESSIBLE KIT: HYGIENIC SEAL 1110x1030x600mm	103	AF 5CLL *	CLINIC LAMINAR AERATOR	42
AC 877 * CF *	ACCESSIBLE KIT: CLAM FLANGE 870x700MM	102	AF 5FVB	AERATOR INSERT BUBBLE SPRAY	42
AC 877 * HS *	ACCESSIBLE KIT: HYGIENIC SEAL 870x700MM	102	AF 5FVL	AERATOR INSERT LAMINAR	42
AC 877 * LR	ACCESSIBLE KIT: LINEAR 870x700MM	102	AF 5FVS	AERATOR INSERT STREAMJETSPRAY	42
AC 966 * CF *	ACCESSIBLE KIT: CLAM FLANGE 960x600MM	103	AF 5TMB	AERATOR INSERT TINY MAN	42
AC 966 * HS *	ACCESSIBLE KIT: HYGIENIC SEAL 960x600MM	103	AF 5TML	AERATOR INSERT TINY MAN LAMINAR	42
AC 966 * LR *	ACCESSIBLE KIT: LINEAR 960x600MM	103	AF 8ALF	ANTI-MICROBIAL AERATOR INSERT LAMINAR	42
AF 00 UNK	UNIVERSAL METAL SERVICE KEY	44	AF 8FVB	AERATOR INSERT BUBBLE SPRAY	42
AF 00 VK	ANTI-VANDAL FITTING KEY	44	AF 8FVL	AERATOR INSERT LAMINAR	42
AF 019 B	FLOW CONTROL DISC	45	AF 8TMB	AERATOR INSERT TINY MAN	42
AF 048	WHISPER WASH - MK1	45	AL 01806 *	ANTI-LIGATURE HOSFAB KIT 6	51
AF 053	BASIN FLOW CONTROL VALVE	45	AL 01809 *	ANTI-LIGATURE HOSFAB KIT 9	51
AF 054	FLOW CONTROL VALVE	45	AL 1200 * HZ	1200mm HORIZONTAL ANTI-LIGATURE LEFT HAND/RIGHT HAND	50
AF 055	FLANGE FLOW CONTROL VALVE	45	AL 1200 * VL	1200mm VERTICAL ANTI-LIGATURE	50
AF 059	3/4 M&F HOSE TAP FLOW REGULATOR	45	AL 450 * HZ	450mm HORIZONTAL ANTI-LIGATURE LEFT HAND/RIGHT HAND	50
AF 086	1/2 FLOW INTERCHANGE SPIGOT	45	AL 450 * VL	450mm VERTICAL ANTI-LIGATURE	50
AF 15DFB	DOMESTIC AERATOR MINI VALVE	42	AL 454 *	ANTI-LIGATURE 450x450mm WITH TOILET ASSIST LEFT HAND/RIGHT HAND	50
AF 15DMB	DOMESTIC AERATOR MINI VALVE	43	AL 600 * HZ	600mm HORIZONTAL ANTI-LIGATURE LEFT HAND/RIGHT HAND	50
AF 20 C	SINK SPRAY SWIVEL AERATOR	43	AL 600 * VL	600mm VERTICAL ANTI-LIGATURE	50
AF 22DFB	DOMESTIC AERATOR FEMALE BUBBLE	43	AL 900 * HZ	900mm HORIZONTAL ANTI-LIGATURE LEFT HAND/RIGHT HAND	50
AF 22DFL	DOMESTIC AERATOR FMLE LAMINAR	43	AL 900 * VL	900mm VERTICAL ANTI-LIGATURE	50
AF 22DFS	DOMESTIC AERATOR FEMALE STREAM	43	AL 966 *	ANTI-LIGATURE 960x600mm WITH TOILET ASSIST LEFT HAND/RIGHT HAND	50
AF 22F	AERATOR FLOW CONTROL ADAPTOR	43	AM 045 * CF	AMBULANT ACCESSIBLE KIT: CLAM FLANGE	108
AF 22VFB	ANTI VAND AERATOR BUBBLE SPRAY	43	AM 045 * HS	AMBULANT ACCESSIBLE KIT: HYGIENIC SEAL	108
AF 22VFS	ANTI VAND AERATOR STREAMJETSPRAY	43	AM 045 * LR	AMBULANT ACCESSIBLE KIT: LINEAR	108
AF 24DMB	DOMESTIC AERATOR MALE BUBBLE	44	AM 454 * CF	AMBULANT ACCESSIBLE KIT: CLAM FLANGE	109
AF 24DML	DOMESTIC AERATOR MALE LAMINAR	44	AM 454 * HS	AMBULANT ACCESSIBLE KIT: HYGIENIC SEAL	109
AF 24DMS	DOMESTIC AERATOR MALE STREAM	44	AM 454 * LR	AMBULANT ACCESSIBLE KIT: LINEAR	109
AF 24M	AERATOR FLOW CONTROL ADAPTOR	44	AS 01803 * CF	ACCESSIBLE SHOWER KIT: CLAM FLANGE	105
AF 24VMB	ANTI VAND AERATOR BUBBLE SPRAY	44	AS 01803 * HS	ACCESSIBLE SHOWER KIT: HYGIENIC SEAL	105
AF 24VMS	ANTI VAND AERATOR STREAMJETSPRAY	44	AS 01820 * CF	ACCESSIBLE SHOWER KIT: CLAM FLANGE	104
AF 2FVS	AERATOR INSERT STREAMJETSPRAY	42	AS 01820 * HS	ACCESSIBLE SHOWER KIT: HYGIENIC SEAL	104

Code A-Z	Description	Page	Code A-Z	Description	Page
BA 101	MODENA SOAP DISH HOLDER	6	BA 780	COMFORT MIRROR DUAL SIDED	10
BA 104	MODENA TOWEL RAIL SINGLE 600mm	7	BA 782	COMFORT CLOTHES LINE RETRACT	11
BA 105	MODENA TOWEL RAIL SINGLE 750mm	7	BB 011 *	BATHROOM RECTANGULAR BASKET - LARGE	11
BA 106	MODENA TOWEL RAIL DOUBLE 600mm	7	BB 017 *	BATHROOM CORNER BASKET - LARGE	11
BA 107	MODENA TOWEL RAIL DOUBLE 750mm	7	BG 01809 *	BARIATRIC HOSFAB K9	58
BA 108	MODENA GLASS SHELF 530mm	6	BG 01816 *	BARIATRIC HOSFAB K16	58
BA 111	MODENA HAND TOWEL RAIL 280mm	7	BG 071 *	BARIATRIC 700x1100mm INVERTED T GRAB RAIL	56
BA 112	MODENA PAPER HOLDER	6	BG 300 *	BARIATRIC 300mm STRAIGHT GRAB RAIL	56
BA 114	MODENA TOILET BRUSH/HOLDER	6	BG 450 *	BARIATRIC 450mm STRAIGHT GRAB RAIL	56
BA 115	MODENA ROBE HOOK SINGLE	6	BG 454 *	BARIATRIC 450x450mm ACCESSIBLE GRAB RAIL	57
BA 700 FR GO	TUMBLER GLASS ONLY	10	BG 600 *	BARIATRIC 600mm STRAIGHT GRAB RAIL	56
BA 701	COMFORT SOAP DISH HOLDER	10	BG 700 *	BARIATRIC 700mm STRAIGHT GRAB RAIL	56
BA 704	COMFORT TOWEL RAIL SINGLE 600mm	8	BG 877 *	BARIATRIC 870x700mm ACCESSIBLE GRAB RAIL	57
BA 705	COMFORT TOWEL RAIL SINGLE 800mm	8	BG 900 *	BARIATRIC 900mm STRAIGHT GRAB RAIL	56
BA 706	COMFORT TOWEL RAIL DOUBLE 600mm	8	BG 966 *	BARIATRIC 960x600mm ACCESSIBLE GRAB RAIL	57
BA 707	COMFORT TOWEL RAIL DOUBLE 800mm	8	BR 395 *	FLOOR MOUNTED BACKREST	54
BA 708	COMFORT STAINLESS STEEL SHELF 500mm	9	BR 400 * CF	WALL MOUNTED BACKREST	54
BA 710	COMFORT STAINLESS STEEL SHELF 350mm	9	BR 400 * HS	WALL MOUNTED BACKREST	54
BA 712	COMFORT PAPER HOLDER	8	BR 404 * HS	WALL MOUNTED BACKREST HIDEAWAY MOUNTING SYSTEM	55
BA 714 BH	TOILET BRUSH HANDLE ONLY	6	BR 440 * CF	WALL MOUNTED BACKREST/450mm	55
BA 714 FR GO	TOILET BRUSH GLASS ONLY	6	BR 440 * HS	WALL MOUNTED BACKREST/450mm	55
BA 714 WT B0	TOILET BRUSH HEAD ONLY	6	BR 444 * HS	WALL MOUNTED BACKREST EXTENDED HIDEAWAY MOUNT	55
BA 715	COMFORT DOUBLE ROBE HOOK	8	CF 01803 *	CLAM FLANGE SHOWER KIT 3	64
BA 718	COMFORT STAINLESS STEEL SHELF 280mm CORNER	9	CF 01809 *	CLAM FLANGE SHOWER KIT 9	64
BA 719	COMFORT FOOTREST	11	CF 01816 *	CLAM FLANGE SHOWER KIT 16	65
BA 722	COMFORT PAPER HOLDER DOUBLE	8	CF 01820 *	CLAM FLANGE SHOWER KIT 20	65
BA 729	COMFORT GLASS SHELF 530mm	9	CF 045 *	CLAM FLANGE 450x450mm ASSIST GRAB RAIL	60
BA 729 * B0	SHELF BARRIER ONLY	9	CF 071 *	CLAM FLANGE 700x1100mm SHOWER GRAB RAIL	62
BA 739	COMFORT GLASS SHELF 260mm CORNER	9	CF 1000 *	CLAM FLANGE 1000mm STRAIGHT GRAB RAIL	60
BA 739 * B0	SHELF BARRIER ONLY	9	CF 116 *	CLAM FLANGE 1110x1030x600mm	61
BA 742	SOAP DISPENSER	10	CF 300 *	CLAM FLANGE 300mm STRAIGHT GRAB RAIL	60
BA 750	COMFORT WALL MOUNT TOILET BRUSH	10	CF 450 *	CLAM FLANGE 450mm STRAIGHT GRAB RAIL	60
BA 769	SHELF MOUNT BRACKETS PAIR	9	CF 454 *	CLAM FLANGE 450x450mm ASSIST	61

* The asterisk represent code variations when there are multiple options available for finishes and/or orientation.

Code A-Z	Description	Page	Code A-Z	Description	Page
CF 600 *	CLAM FLANGE 600mm STRAIGHT GRAB RAIL	60	FM 070 BE	BASIN FLOW MEASURING CUP	47
CF 700 *	CLAM FLANGE 700mm STRAIGHT GRAB RAIL	60	FM 075 BE	SHOWER FLOW MEASURING JUG	47
CF 711 *	CLAM FLANGE 760x1000x1100mm CORNER GRAB RAIL	62	FS 038	FLOOD STOP VALVE	46
CF 761 *	CLAM FLANGE 760x1000mm CORNER GRAB RAIL	61	GS 071J *	HOME CARE STREAMJET	73
CF 818 *	CLAM FLANGE 800mm FREE STANDING	91	GS 071P	HOME CARE PRINCESS	73
CF 877 *	CLAM FLANGE 870x700mm ASSIST GRAB RAIL	60	GS 071S	HOME CARE STREAMJET XL TURBO	73
CF 900 *	CLAM FLANGE 900mm STRAIGHT GRAB RAIL	60	GS 071T	HOME CARE STREAMJET TURBO	73
CF 966 *	CLAM FLANGE 960x600mm ASSIST	61	GS 071X	HOME CARE STREAMJET XL	73
CR 300 *	COMFORT BATHROOM RAIL 300mm	11	GS 071Z	HOME CARE BREEZE	73
CR 450 *	COMFORT BATHROOM RAIL 300mm	11	GS 900J *	HOME CARE STREAMJET	72
CR 600 *	COMFORT BATHROOM RAIL 600mm	11	GS 900P	HOME CARE PRINCESS	72
CR 900 *	COMFORT BATHROOM RAIL 900mm	11	GS 900S	HOME CARE STREAMJET XL TURBO	72
CR 900J *	STREAMJET/900mm COMFORT RAIL	22	GS 900T	HOME CARE STREAMJET TURBO	72
CR 900P	PRINCESS/900mm COMFORT RAIL	22	GS 900X *	HOME CARE STREAMJET XL	72
CR 900S	STREAMJET XL TURBO/900mm COMFORT RAIL	22	GS 900Z	HOME CARE BREEZE	72
CR 900T	STREAMJET TURBO/900mm COMFORT RAIL	22	HC 010 *	BRASS FRICTION SLIDE CRADLE	35
CR 900X *	STREAMJET XL/900mm COMFORT RAIL	22	HC 020 *	BRASS SLIDE RAIL H/P CRADLE	35
CR 900Z	BREEZE PULS/900mm COMFORT RAIL	22	HC 024 *	GRAB RAIL GLIDE SLIDE HANDSET CRADLE	52, 94
CS 007	COBRA VANDAL PROOF	21	HC 025 *	ABS PUSH BUTTON SLIDE CRADLE	35
CS 008	PIONEER TAMPER PROOF	21	HC 932 *	32mm FRICTION SLIDE CRADLE	94
CS 009	VANGUARD VANDAL PROOF	21	HF 071J *	PREMIUM STREAMJET	75
CS 061	ZODIAC TAMPER PROOF/55mm ARM	21	HF 071P	PREMIUM PRINCESS	75
DC 042	DUAL CHECK/FLOW REG 1/2 M&F	46	HF 071S	PREMIUM STREAMJET XL TURBO	75
DC 043 *	DUAL CHECK/NON RETURN 1/2 F&M	46	HF 071T	PREMIUM STREAMJET TURBO	75
DC 057	DUAL CHECK/NON RETURN 1/2 M&M	46	HF 071X *	PREMIUM STREAMJET XL	75
DV 021	SWITCHCOCK VALVE	39	HF 071Z	PREMIUM BREEZE	75
DV 044	ON/OFF BUTTON CONTROL VALVE	32	HF 900J *	PREMIUM STREAMJET	74
EB 044	ANTI LIGATURE WALL OUTLET	32	HF 900T	PREMIUM STREAMJET TURBO	74
EB 045	WALL OUTLET ELBOW/DUAL CHECK	32	HF 900X *	PREMIUM STREAMJET XL	74
EB 046 *	WALL OUTLET ELBOW/DUAL CHECK	32	HF 900Z	PREMIUM BREEZE	74
EB 073 *	WALL OUTLET BRACKET/DUAL CHECK	32	HF 932 *	HYGIENIC SEAL 900mm RAIL SLIDE CRADLE	95
EB 074	WALL MOUNT HANDSET BRACKET	32	HM 019 *	HOB MOUNT SET	39
EB 085	WALL MOUNT ABS HANDSET BRACKET	32	HP 025 *	KLIPPER ON/OFF HANDPIECE	37

Code A-Z	Description	Page	Code A-Z	Description	Page
HP 030 *	HOSCARE HANDPIECE	37	HS 01804S	STREAMJET XL TURBO KIT 4	98
HP 034	PRINCESS HANDPIECE	37	HS 01804T	STREAMJET TURBO KIT 4	98
HP 035 *	HOSFAB HANDPIECE	37	HS 01804X *	STREAMJET XL KIT 4	98
HP 037	BREEZE PULSATOR HANDPIECE	37	HS 01805 *	COMMERCIAL KIT 5	78
HP 038 *	STREAMJET HANDPIECE	36	HS 01806 *	ANTIMICROBIAL KIT 6	53
HP 041	QUEWB HANDPIECE	36	HS 01806H *	COMMERCIAL HOSCARE KIT 6	96
HP 042	STREAMJET TURBO HANDPIECE	36	HS 01806J *	STREAMJET KIT 6	96
HP 130 *	STREAMJET XL HANDPIECE	36	HS 01806P	PRINCESS KIT 6	96
HP 142	STREAMJET XL TURBO PULSATOR HANDPIECE	36	HS 01806S	STREAMJET XL TURBO KIT 6	96
HR 015 *	HOSE RESTRICTOR BRACKET	94/107	HS 01806T	STREAMJET TURBO PULSATOR KIT 6	96
HS 010J *	STREAMJET/CRYSTAL SLIDE RAIL	23	HS 01806X	STREAMJET XL KIT 6	96
HS 010P	PRINCESS/CRYSTAL SLIDE RAIL	23	HS 01808H *	COMMERCIAL HOSCARE KIT 8	99
HS 010S	STREAMJET XL TURBO/CRYSTAL SLIDE RAIL	23	HS 01808J *	STREAMJET KIT 8	99
HS 010T	STREAMJET TURBO/CRYSTAL SLIDE RAIL	23	HS 01808P	PRINCESS KIT 8	99
HS 010U	QUEWB/SQUARE EDGE SLIDE RAIL	29	HS 01808S	STREAMJET XL TURBO KIT 8	99
HS 010X	STREAMJET XL/CRYSTAL SLIDE RAIL	23	HS 01808T	STREAMJET TURBO KIT 8	99
HS 010Z	BREEZE PULS/CRYSTAL SLIDE RAIL	23	HS 01808X *	STREAMJET XL KIT 8	99
HS 011J *	STREAMJET/WALL OUTLET BRACKET	24	HS 01809 *	ANTIMICROBIAL KIT 9	53
HS 011P	PRINCESS/WALL OUTLET BRACKET	24	HS 01810H *	COMMERCIAL HOSCARE KIT 10	97
HS 011S	STREAMJET XL TURBO/WALL OUTLET BRACKET	24	HS 01810J *	STREAMJET KIT 10	97
HS 011T	STREAMJET TURBO/WALL OUTLET BRACKET	24	HS 01810P	PRINCESS KIT 10	97
HS 011X *	STREAMJET XL/WALL OUTLET BRACKET	24	HS 01810S	STREAMJET XL TURBO KIT 10	97
HS 011Z *	BREEZE PULSATOR/WALL OUTLET BRACKET	24	HS 01810T	STREAMJET TURBO KIT 10	97
HS 017H *	HOSCARE HANDHELD KIT FOR RAILS	25	HS 01810X	STREAMJET XL KIT 10	97
HS 017J *	STREAMJET HANDHELD KIT FOR RAILS	25	HS 01812 *	ANTIMICROBIAL KIT 12	53
HS 017P	PRINCESS HANDHELD KIT FOR RAILS	25	HS 01813 *	COMMERCIAL KIT 13	78
HS 017S	STREAMJET XL TURBO HANDHELD KIT FOR RAILS	25	HS 01816 *	COMMERCIAL KIT 16	79
HS 017T	STREAMJET TURBO HANDHELD KIT FOR RAILS	25	HS 01820 *	COMMERCIAL KIT 20	79
HS 017X *	STREAMJET XL HANDHELD KIT FOR RAILS	25	HS 020J *	STREAMJET/POLAR RAIL	26
HS 01803 *	COMMERCIAL KIT 3	77	HS 020P	PRINCESS/POLAR RAIL	26
HS 01804H *	HOSCARE KIT 4	98	HS 020S	STREAMJET XL TURBO/POLAR RAIL	26
HS 01804J *	STREAMJET KIT 4	98	HS 020T	STREAMJET TURBO/POLAR RAIL	26
HS 01804P	PRINCESS KIT 4	98	HS 020X *	STREAMJET XL/POLAR RAIL	26

* The asterisk represent code variations when there are multiple options available for finishes and/or orientation.

Code A-Z	Description	Page	Code A-Z	Description	Page
HS 020Z C	BREEZE PULS/POLAR RAIL	26	HS 1100 *	HYGIENIC SEAL 1100mm STRAIGHT GRAB RAIL	67
HS 026J *	STREAMJET/RIVIERA SLIDE RAIL	27	HS 116 *	HYGIENIC SEAL 1110x1030x600mm ASSIST	69
HS 026P	PRINCESS/RIVIERA SLIDE RAIL	27	HS 1200 *	HYGIENIC SEAL 1200mm STRAIGHT GRAB RAIL	67
HS 026S	STREAMJET XL TURBO/RIVIERA SLIDE RAIL	27	HS 200 *	HYGIENIC SEAL 200mm STRAIGHT GRAB RAIL	66
HS 026T	STREAMJET TURBO/RIVIERA SLIDE RAIL	27	HS 300 *	HYGIENIC SEAL 300mm STRAIGHT GRAB RAIL	66
HS 026X *	STREAMJET XL/RIVIERA SLIDE RAIL	27	HS 300 **	HYGIENIC SEAL 300mm WITH TOILET ROLL	67
HS 026Z *	BREEZE PULS/RIVIERA SLIDE RAIL	27	HS 400 *	HYGIENIC SEAL 400mm STRAIGHT GRAB RAIL	66
HS 030J *	STREAMJET/ANTONIO RAIL	28	HS 432 * BF	RETROFIT BACKREST KIT - SET OF 4	93
HS 030P	PRINCESS/ANTONIO RAIL	28	HS 432 * SF	RETROFIT SHOWER SEAT KIT - SET OF 4	93
HS 030S	STREAMJET XL TURBO/ANTONIO RAIL	28	HS 450 *	HYGIENIC SEAL 450mm STRAIGHT GRAB RAIL	66
HS 030T	STREAMJET TURBO/ANTONIO RAIL	28	HS 450 **	HYGIENIC SEAL 450mm WITH TOILET ROLL	67
HS 030X	STREAMJET XL/ANTONIO RAIL	28	HS 454 *	HYGIENIC SEAL 450x450mm ASSIST	68
HS 030Z	BREEZE/ANTONIO RAIL	28	HS 500 *	HYGIENIC SEAL 500mm STRAIGHT GRAB RAIL	66
HS 032 * FC	HYGIENIC SEAL FLANGE COVER	92	HS 600 *	HYGIENIC SEAL 600mm STRAIGHT GRAB RAIL	66
HS 032 B BB10	HYGIENIC SEAL BACK/BACK SYSTEM - 10mm	93	HS 700 *	HYGIENIC SEAL 700mm STRAIGHT GRAB RAIL	66
HS 032 B BB15	HYGIENIC SEAL BACK/BACK SYSTEM - 15mm	93	HS 711 *	HYGIENIC SEAL 760x1000x1100mm SHOWER RECESS	70
HS 032 B BB30	HYGIENIC SEAL BACK/BACK SYSTEM - 30mm	93	HS 750 *	HYGIENIC SEAL 750mm STRAIGHT GRAB RAIL	66
HS 032 B MP	HYGIENIC SEAL WALL MOUNT PLATE	92	HS 761 *	HYGIENIC SEAL 760x1000mm CORNER	69
HS 032 BS BM	SHOWER SEAT WALL MOUNT PLATE	92	HS 775 *	HYGIENIC SEAL 750x750mm WITH TOILET ASSIST	68
HS 032 C BE10	HYGIENIC SEAL SINGLE SIDED SYSTEM	93	HS 800 *	HYGIENIC SEAL 800mm STRAIGHT GRAB RAIL	67
HS 032 C BE15	HYGIENIC SEAL SINGLE SIDED SYSTEM	93	HS 877 *	HYGIENIC SEAL 870x700mm ASSIST	68
HS 032 C BE30	HYGIENIC SEAL SINGLE SIDED SYSTEM	93	HS 880 *	HYGIENIC SEAL 800x800mm CORNER	69
HS 032 * BF	HYGIENIC SEAL BLANK END FLANGE	92	HS 900 *	HYGIENIC SEAL 900mm STRAIGHT GRAB RAIL	67
HS 032 PS SP	HYGIENIC SEAL STAND OFF PLATE	92	HS 966 *	HYGIENIC SEAL 960x600mm ASSIST	68
HS 036J *	STREAMJET/RIVIERA RAIL BOTTOM INLET	27	HT 600 * D	HYGIENIC SEAL 600mm/D TOWEL RAIL	71
HS 036P	PRINCESS/RIVIERA RAIL BOTTOM INLET	27	HT 600 * U	HYGIENIC SEAL 600mm/U TOWEL RAIL	71
HS 036S	STREAMJET XL TURBO/RIVIERA RAIL BOTTOM INLET	27	HT 800 * D	HYGIENIC SEAL 800mm/D TOWEL RAIL	71
HS 036T	STREAMJET/RIVIERA RAIL BOTTOM INLET	27	HT 800 * U	HYGIENIC SEAL 800mm/U TOWEL RAIL	71
HS 036X *	STREAMJET XL/RIVIERA RAIL BOTTOM INLET	27	IC 01803 *	CLAM FLANGE ACCESSIBLE KIT 3	63
HS 036Z	BREEZE/RIVIERA RAIL BOTTOM INLET	27	IC 01820 *	CLAM FLANGE ACCESSIBLE KIT 20	63
HS 045 *	HYGIENIC SEAL 450x450mm	68	ID 01803 *	INDEPENDENT ACCESSIBLE KIT 3	76
HS 071 *	HYGIENIC SEAL 700x1100mm SHOWER RECESS	70	ID 01804H *	ACCESSIBLE HOSCARE KIT 4	100
HS 1000 *	HYGIENIC SEAL 1000mm STRAIGHT GRAB RAIL	67	ID 01804J *	ACCESSIBLE STREAMJET KIT 4	100

Code A-Z	Description	Page	Code A-Z	Description	Page
ID 01804P	ACCESSIBLE PRINCESS KIT 4	100	LR 877 *	LINEAR 870x700mm ASSIST GRAB RAIL	81
ID 01804S	ACCESSIBLE STREAMJET XL TURBO KIT 4	100	LR 900 *	LINEAR 900mm STRAIGHT GRAB RAIL	80
ID 01804T	ACCESSIBLE STREAMJET TURBO KIT 4	100	LR 966 *	LINEAR 960x600mm ASSIST GRAB RAIL	81
ID 01804X	ACCESSIBLE STREAMJET XL KIT 4	100	LT 071CJ *	LINEAR TWIN COSMIC/STREAMJET 700x1100mm	86-87
ID 01808H AC	ACCESSIBLE HOSCARE KIT 8	101	LT 071CP *	LINEAR TWIN COSMIC/PRINCESS 700x1100mm	86-87
ID 01808J	ACCESSIBLE STREAMJET KIT 8	101	LT 071CS *	LINEAR TWIN COSMIC/STREAMJET XL TURBO 700x1100mm	86-87
ID 01808P	ACCESSIBLE PRINCESS KIT 8	101	LT 071CT *	LINEAR TWIN COSMIC/STREAMJET TURBO 700x1100mm	86-87
ID 01808S	ACCESSIBLE STREAMJET XL TURBO KIT 8	101	LT 071CX *	LINEAR TWIN COSMIC/STREAMJET XL 700x1100mm	86-87
ID 01808T	ACCESSIBLE STREAMJET TURBO KIT 8	101	LT 071CZ *	LINEAR TWIN COSMIC/BREEZE 700x1100mm	86-87
ID 01808X	ACCESSIBLE STREAMJET XL KIT 8	101	LT 110CJ *	LINEAR TWIN COSMIC/STREAMJET 1100mm	84-85
ID 01820 *	INDEPENDENT ACCESSIBLE KIT 20	76	LT 110CP *	LINEAR TWIN COSMIC/PRINCESS 1100mm	84-85
LF 079J *	LINEAR KIT/STREAMJET 700mm+900mm	83	LT 110CS *	LINEAR TWIN COSMIC/STREAMJET XL TURBO 1100mm	84-85
LF 079P	LINEAR KIT/PRINCESS 700mm+900mm	83	LT 110CT *	LINEAR TWIN COSMIC/STREAMJET TURBO 1100mm	84-85
LF 079S	LINEAR KIT/STREAMJET XL TURBO 700mm+900mm	83	LT 110CX *	LINEAR TWIN COSMIC/STREAMJET XL 1100mm	84-85
LF 079T	LINEAR KIT/STREAMJET TURBO 700mm+900mm	83	LT 110CZ *	LINEAR TWIN COSMIC/BREEZE 1100mm	84-85
LF 079X *	LINEAR KIT/STREAMJET XL 700mm+900mm	83	LT 111CJ *	LINEAR TWIN COSMIC/STREAMJET 1100mm	84-85
LF 079Z	LINEAR KIT/BREEZE 700mm+900mm	83	LT 111CP *	LINEAR TWIN COSMIC/PRINCESS 1100mm	84-85
LF 900J *	LINEAR STREAMJET	82	LT 111CS *	LINEAR TWIN COSMIC/STREAMJET XL TURBO 1100mm	84-85
LF 900P	LINEAR PRINCESS	82	LT 111CT *	LINEAR TWIN COSMIC/STREAMJET TURBO 1100mm	84-85
LF 900S	LINEAR STREAMJET XL TURBO	82	LT 111CX *	LINEAR TWIN COSMIC/STREAMJET XL 1100mm	84-85
LF 900T	LINEAR STREAMJET TURBO	82	LT 111CZ *	LINEAR TWIN COSMIC/BREEZE 1100mm	84-85
LF 900X *	LINEAR STREAMJET XL	82	LT 600 * D	LINEAR 600MM/D TOWEL RAIL	81
LF 900Z	LINEAR BREEZE	82	LT 600 * U	LINEAR 600mm/U TOWEL RAIL	81
LF 932 *	LINEAR 900mm RAIL SLIDE CRADLE	95	LT 800 * D	LINEAR 800mm/D TOWEL RAIL	81
LL 850	850mm LIFT-N-LOCK GRAB RAIL	91	LT 800 * U	LINEAR 800mm/U TOWEL RAIL	81
LR 045 *	LINEAR 450x450mm ASSIST	81	MB 043 FP	SPINDLE FLUSH PLUG	47
LR 079 *	LINEAR SHOWER RECESS KIT: 700mm+900mm	80	MB 043 IK	METER-BEATER INSTALLATION KIT	47
LR 300 *	LINEAR 300mm STRAIGHT GRAB RAIL	80	MB 043 RT	METER-BEATER REAMER TOOL	47
LR 450 *	LINEAR 450mm STRAIGHT GRAB RAIL	80	MB 043 TT	METER-BEATER TAPPING TOOL	47
LR 454 *	LINEAR 450x450mm ASSIST GRAB	81	MB 045 OR*	METER-BEATER O-RING SEAL	47
LR 600 *	LINEAR 600mm STRAIGHT GRAB RAIL	80	MB 045	METER-BEATER 1/2 SCREW DOWN	47
LR 700 *	LINEAR 700mm STRAIGHT GRAB RAIL	80	MB 047	METER-BEATER 1/2 CERAMIC DISC	47
LR 800 *	LINEAR 800mm STRAIGHT GRAB RAIL	80	OH 005A	PADDINGTON ROSE ONLY	13

* The asterisk represent code variations when there are multiple options available for finishes and/or orientation.

Code A-Z	Description	Page	Code A-Z	Description	Page
OH 005D	PADDINGTON/300mm CLICKLOCK ARM	13	OH 038T *	RAINSTORM 150MM VERTICAL ARM	20
OH 005E	PADDINGTON/290mm SWAN NECK ARM	13	OH 038U *	RAINSTORM 300MM VERTICAL ARM	20
OH 005H	PADDINGTON/450mm HORIZONTAL ARM	13	OH 038W *	RAINSTORM 450MM VERTICAL ARM	20
OH 005T	PADDINGTON/150mm VERTICAL ARM	13	OH 038X *	RAINSTORM 600MM VERTICAL ARM	20
OH 005U	PADDINGTON/300mm VERTICAL ARM	13	OR 080C *	COSMIC/OVERHEAD RAIL 800MM	17
OH 005W	PADDINGTON/450mm VERTICAL ARM	13	OR 080Q	QUEWB/OVERHEAD RAIL 800MM	19
OH 005X	PADDINGTON/600mm VERTICAL ARM	13	PM 932	32mm PUSH PULL ME CRADLE ROD	94
OH 006A *	STREAMJET ROSE ONLY	14	SA 005	55mm LIMITED PROJECTION ARM	34
OH 006B *	STREAMJET/150mm FIXED ARM	14	SA 030 *	150mm UPSWEPT FIXED ARM	35
OH 006D *	STREAMJET/300mm CLICKLOCK ARM	14	SA 060 *	300mm CLICKLOCK ORB/ADJ ARM	34
OH 006E *	STREAMJET/290mm SWAN NECK ARM	14	SA 070 *	260MM UPSWEPT ADJUSTABLE ARM	35
OH 006G *	STREAMJET/165mm GRAND ARM	14	SA 090 *	290mm SWAN NECK ARM	34
OH 008A *	STREAMJET XL ROSE ONLY	15	SA 140 *	140mm SWIVEL CRANE NECK ARM	34
OH 008B *	STREAMJET XL/150mm FIXED ARM	15	SA 150 *	150MM VERTICAL ARM	35
OH 008D *	STREAMJET XL/300mm CLICKLOCK	15	SA 165 *	165mm GRAND ARM	34
OH 008E *	STREAMJET XL/290mm SWAN NECK	15	SA 300 *	300MM VERTICAL ARM	35
OH 008G	STREAMJET XL/165mm GRAND ARM	15	SA 310 *	310mm HORIZONTAL ARM	34
OH 028A *	COSMIC ROSE ONLY	16	SA 345 *	345mm SWIVEL SWAN NECK ARM	34
OH 028H *	COSMIC/310mm HORIZONTAL ARM	16	SA 380 *	380mm SWIVEL CRANE NECK ARM	34
OH 028K *	COSMIC/450mm HORIZONTAL ARM	16	SA 450 *	450MM VERTICAL ARM	35
OH 028Q *	COSMIC/380mm CRANE NECK ARM	16	SA 600 *	600MM VERTICAL ARM	35
OH 028T *	COSMIC/150mm VERTICAL ARM	17	SD 025 CL	25mm ABS SOAP DISH	35
OH 028U *	COSMIC/150mm VERTICAL ARM	17	SD 032 *	GRAB RAIL SOAP DISH HOLDER	94
OH 028W *	COSMIC/450mm VERTICAL ARM	17	SH 0025 *	25M BULK HOSE	38
OH 028X *	COSMIC/600mm VERTICAL ARM	17	SH 027 BL HW	20 WASHERS - NITRIL N70	39
OH 030A	QUEWB ROSE ONLY	18	SH 027 C CN-10	10 CONICAL END NUTS	39
OH 030H	QUEWB/310mm HORIZONTAL ARM	18	SH 027 C LV-20	20 HOSE SLEEVES - 15mm	39
OH 030Q	QUEWB/380mm CRANE NECK ARM	18	SH 027 C SV-20	20 HOSE SLEEVES - 14mm	39
OH 030T	QUEWB/150mm VERTICAL ARM	19	SH 027 GR EG-20	20 EEL GRIP SEALS - DELRIN	39
OH 030U	QUEWB/300mm VERTICAL ARM	19	SH 027 TR	TRADESMAN HOSE REPAIR KIT	39
OH 030W	QUEWB/450mm VERTICAL ARM	19	SH 0900 *	900MM HOSE	38
OH 030X	QUEWB/600mm VERTICAL ARM	19	SH 1200 *	1200MM HOSE	38
OH 038A *	RAINSTORM ROSE ONLY	20	SH 1500 *	1500MM HOSE	38

Code A-Z	Description	Page
SH 2000 *	2000MM HOSE	38
SH 3000 AW	3000MM ANTIMICROBIAL HOSE	52
SH 4000 AW	4000MM ANTIMICROBIAL HOSE	52
SL 850 *	850mm SWINGLOCK	91
SP 063	ADJUSTABLE ARM OLIVE (2 PACK)	35
SP 140 * TO	140mm SWIVEL CRANE TUBE ONLY	33
SR 010 *	CRYSTAL SLIDE RAIL	33
SR 020 *	POLAR SLIDE RAIL	33
SR 025 *	SWAN NECK TWIN WATERS RAIL	33
SR 025 * OL	300mm OVERHEAD EXTENSION	33
SR 025 * OM	200mm OVERHEAD EXTENSION	33
SR 025 * OS	100mm OVERHEAD EXTENSION	33
SR 026 *	RIVIERA SLIDE RAIL	33
SR 028 C	QUEWB SLIDE RAIL	33
SR 029 *	CRANE NECK TWIN WATERS RAIL	33
SR 400 C RA	400mm RAIL TUBE ONLY	33
SR 700 *	700mm FRICT SLID/CRADLE/COLLAR	95
SS 604 *	600x400mm SAFE-ASSIST SHOWER SEAT	89
SS 645	450x600mm SEAT/LIMITED WALL	89
SS 845	800x450mm SHOWER SEAT	89
SS 945	960x450mm SAFE-ASSIST SHOWER SEAT	89
SS 964 *	960x400mm SAFE-ASSIST SHOWER SEAT	88
SS 965 *	960x500mm BARIATRIC SEAT	88
TL 850 *	TILTLOCK 850mm GRAB RAIL	90
TR 031 *	GRAB RAIL TOILET ROLL HOLDER	92
TW 025CJ *	COSMIC/STREAMJET TWIN WATERS	30
TW 025CP	COSMIC/PRINCESS TWIN WATERS	30
TW 025CS	COSMIC/STREAMJET XL TURBO TWIN WATERS	30
TW 025CT	COSMIC/STREAMJET PULS TWIN WATERS	30
TW 025CX *	COSMIC/STREAMJET XL TWIN WATERS	30
TW 025CZ	COSMIC/BREEZE TWIN WATERS	30
TW 029CJ *	COSMIC/STREAMJET TWIN WATERS/CRANE	31
TW 029CP	COSMIC/PRINCESS TWIN WATERS/CRANE	31

Code A-Z	Description	Page
TW 029CS	COSMIC/STREAMJET XL TURBO TWIN WATERS/CRANE	31
TW 029CT	COSMIC/STREAMJET PULS TWIN WATERS/CRANE	31
TW 029CX *	COSMIC/STREAMJET XL TWIN WATERS/CRANE	31
TW 029CZ	COSMIC/BREEZE TWIN WATERS/CRANE	31
TW 035CJ *	COSMIC/STREAMJET TWIN WATERS BOTTOM INLET	30
TW 035CP	COSMIC/PRINCESS TWIN WATERS BOTTOM INLET	30
TW 035CS	COSMIC/STREAMJET XL TURBO TWIN WATERS BOTTOM INLET	30
TW 035CT	COSMIC/STREAMJET TURBO TWIN WATERS BOTTOM INLET	30
TW 035CX *	COSMIC/STREAMJET XL TWIN WATERS BOTTOM INLET	30
TW 035CZ	COSMIC/BREEZE TWIN WATERS BOTTOM INLET	30
TW 039CJ *	COSMIC/STREAMJET TWIN WATERS BOTTOM INLET	31
TW 039CP	COSMIC/PRINCESS TWIN WATERS BOTTOM INLET	31
TW 039CS	COSMIC/STREAMJET XL TURBO TWIN WATERS BOTTOM INLET	31
TW 039CT	COSMIC/STREAMJET TURBO TWIN WATERS BOTTOM INLET	31
TW 039CX *	COSMIC/STREAMJET XL TWIN WATERS BOTTOM INLET	31
TW 039CZ	COSMIC/BREEZE TWIN WATERS BOTTOM INLET	31
WB 001	COMFORT RECTANGULAR BASKET - LARGE	12
WB 002	COMFORT RECTANGULAR BASKET - MEDIUM	12
WB 003	COMFORT RECTANGULAR BASKET - SMALL	12
WB 004	COMFORT RECTANGULAR BASKET OPEN - MEDIUM	12
WB 005	COMFORT RECTANGULAR BASKET OPEN - SMALL	12
WB 006	COMFORT CORNER BASKET WITH HOOK	12
WB 008	COMFORT CORNER BASKET - MEDIUM	12
WF 057 * DO	57mm BRASS DOMED FLANGE	33
WF 057 * FL	57mm BRASS HD FLAT FLANGE	33
WF 057 * QU	57mm SQUARE WALL FLANGE	33

* The asterisk represent code variations when there are multiple options available for finishes and/or orientation.

Certification & Licencing

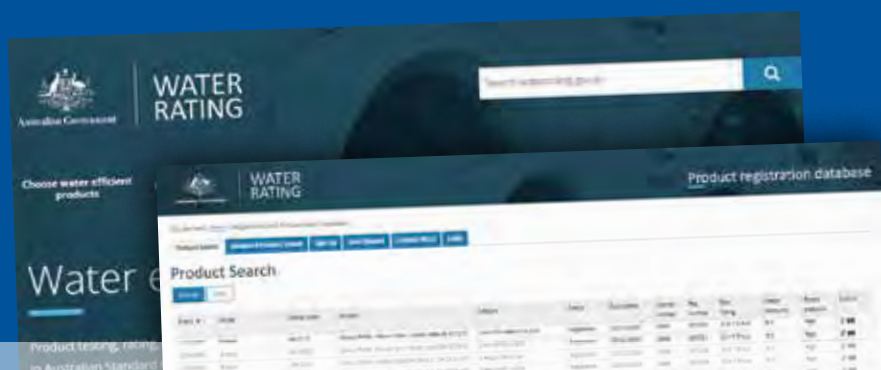

Plumbing products sold in Australia must have WaterMark certification and a registered licence under the Water Efficiency Labelling and Standards (WELS) scheme. Certification and licencing confirm the product complies with the Plumbing Code of Australia, is fit for purpose and meets the relevant Australian Standards. All Con-Serv showers, flow controls devices and dual check/non-return valves possess the WaterMark Certificate of Conformity, and fulfill all requirements for licencing purposes by the Water Efficiency Labelling and Standards scheme.

PRODUCT RANGE	WATERMARK CERTIFICATE	WELS LICENCE	RATING
Anti-Ligature Showers	AS 3662 WMKT 21147	0046	3 & 4 Star
Antimicrobial Showers		0046	3 & 4 Star
Bariatric Showers		0046	3 & 4 Star
Clam® Flange Showers		0046	3 & 4 Star
Handheld Showers		0046	3 & 4 Star
Hygienic Seal® Showers		0046	3 & 4 Star
Linear Showers		0046	3 & 4 Star
Linear Twin Waters™		0046	3 Star
Overhead Showers		0046	3 & 4 Star
Rail Showers		0046	3 & 4 Star
Shower Hoses		N/A	N/A
Tamper Resistant Showers		0046	3 & 4 Star
Twin Waters™		0046	3 Star
Vandal Resistant Showers		0046	3 & 4 Star
Aerators	AS 5200.037.2 WMKA 00667	0046	3, 5 & 6 Star
Flow Regulated Valves		0046	3, 5 & 6 Star
Meter-Beater®		0046	3, 5 & 6 Star
Dual Check/Non-Return	AS/NZS 2845.1 WMKA 02696	N/A	N/A
Elbows & Brackets		0046	3, 5 & 6 Star
Flood Stop	WMTS 479:2018 WMK 25895	N/A	N/A

For further information regarding certification and licencing, please use the following links:

- WaterMark Certification Scheme:
<https://www.abcb.gov.au/Product-Certification/WaterMark-Certification-Scheme>
- Water Efficient Labelling Scheme:
<https://www.waterrating.gov.au/>

*All information tabled correct at time of printing



CON-SERV CORPORATION AUSTRALIA PTY. LTD.
17 Glentanna Street, Kedron Qld. 4031 Australia
Phone: +61 (0)7 3630 5744 · Fax: +61 (0)7 3630 5755
Email: mail@con-serv.com.au · www.con-serv.com.au