



**AUSTRALIA'S  
ULTIMATE  
RANGE OF  
CONTRACTORS  
TOOLS**

**A.G.PULIE**

PROUDLY AUSTRALIAN OWNED  
SINCE 1951

*Cemtool* **MASTERFINISH** *Easymix*



## HEAD OFFICE

E: [sales@masterfinish.com.au](mailto:sales@masterfinish.com.au)

P: 02 96379011

## Welcome

Welcome to the A.G. Pulie catalogue. We would like to invite you to browse our catalogue whereby you can find all the world's leading brands in concreting and associated trades, tools and equipment. With decades of experience, you'll find we are the experts in the trade. Please feel free to contact us for any enquiries or for your nearest outlet.

## Quality

The management and staff of A.G. Pulie are committed to the best possible professional practice and providing the highest quality services to our clients.

It is our pleasure to introduce a great range of quality products that A.G. Pulie has sourced from Australia and overseas. We have taken the time to listen to our customer's needs and source only the best products for the job.

## Technology

A.G. Pulie's research and development team are constantly looking at ways to best serve and supply our customers.

Whether it's an ergonomically designed handle or a light weight material, it's the attention to detail that makes our products stand out from the rest. Ultimately this makes life easier for our customers.

## Reliability

What is reliability?  
How do we measure it?

1. Consistency
2. Performance
3. Trustworthy
4. Availability
5. Quality

Reliability goals are an essential part in the growth of A.G. Pulie.

## Integrity

We behave ethically, are honest and fair with each other and our customers, take responsibility for all our actions and acknowledge that as an organisation we have moral obligations as well as commercial ones.



Albert Pulie  
Managing Director



## Handtools

pages 04 - 43

Concrete  
Brick  
Render & Plaster  
Tile  
General  
Specialty

pointed trowels, coves, bullfloats, screeds, rakes, floats  
brick trowels, brushes...  
trowels, hawks...  
trowels, spreaders...  
sprayers, scrapers...  
texture rakes, bump cutters, asphalt, shovels



## Brick Tools

pages 44 - 53

Clamps  
Builders Line

internal & external, ironers, jointers, rakers  
line pins, dutch pins, line blocks, builders line, brick tapes, trestles



## Materials Handling

pages 54 - 65

Wheelbarrows  
Trolleys

steel, poly, specialised...  
p-handle, sack trucks...



## Machinery

pages 66 - 117

Vibration  
Pumping  
Saws  
Surface Preparation  
Power Screeds  
Trowel Machines  
Cement Mixers  
Compaction  
Specialty Tools

pendulum vibrating shafts  
submersible pumps, hoses, drive units...  
bricksaws, blocksaws...  
floor grinders,...  
floating, twin beam...  
machines, blades, accessories...  
electric, petrol...  
plate compactors, vertical rammers...  
post removers, post drivers, generator...



## Formwork

pages 118 - 125

Tools  
Accessories

end cutting nips, wire twisters, bolt cutters, reo benders...  
rebate brackets, kerb bows & plates...

## Gladiator

pages 126 - 133





**A.G PULIE**

**HANDTOOLS**

**SECTION 1**







# POINTED TROWELS

Used for trowelling concrete floors or similar work. The curve of the blade end allows for the reduction of blade end marking. The moulded plastic handle is designed for ease of grip and operator comfort.



109A



190A



109SS



161A

Pointed Trowels						
Code	Description	Width	Length	Gauge	Pack Qty	Barcode
101A	Carbon Steel Pointed Trowel	120mm	365mm	Light	12	9318428101010
103A	Carbon Steel Pointed Trowel	120mm	365mm	Heavy	12	9318428101034
109A	Carbon Steel Pointed Trowel	100mm	355mm	Light	12	9318428101096
109SS	Stainless Steel Pointed Trowel	100mm	355mm	S/S	12	9318428101904
161A	Carbon Steel Pointed Trowel	120mm	660mm	Heavy	12	9318428101614
165A	Carbon Steel Pointed Trowel	115mm	600mm	Light	12	9318428101652
190A	Carbon Steel Pointed Trowel	100mm	405mm	Light	12	9318428101188
191A	Carbon Steel Pointed Trowel	115mm	405mm	Light	12	9318428101911
191SS	Stainless Steel Pointed Trowel	115mm	405mm	S/S	12	9318428291971
192A	Carbon Steel Pointed Trowel	115mm	450mm	Light	12	9318428101928
193A	Carbon Steel Pointed Trowel	115mm	500mm	Light	12	9318428101935

# SQUARE TROWELS

Used where the pointed end trowel is not suitable e.g. finishing stair topings and kerb & gutter.



162A



102A

Square Trowels						
Code	Description	Width	Length	Gauge	Pack Qty	Barcode
102A	Carbon Steel Square Trowel	120mm	280mm	Light	12	9318428101027
162A	Carbon Steel Square Trowel	120mm	280mm	Heavy	12	9318428101621
181A	Carbon Steel Square Trowel	115mm	405mm	Light	12	9318428101812
PP73	Carbon Steel Square Trowel	120mm	365mm	Light	12	9318428100730



181A



# STEEL FLOATS

Used to 'rub up' a concrete floor prior to steel trowelling, to work in coloured dry shake or create a 'cove' or 'stipple' finish. They produce a textured finish smoother than a wood float, which suits outdoor paving applications. The floats feature a long-wearing robust steel blade that is turned up all round.



Steel Floats					
Code	Description	Width	Length	Pack Qty	Barcode
209	Stainless Steel Float	160mm	210mm	6	9318428112092
219	Carbon Steel Float	150mm	380mm	12	9318428112191
229	Carbon Steel Float	100mm	290mm	12	9318428112290
239	Swirl Finish Trowel	115mm	311mm	12	9318428110210

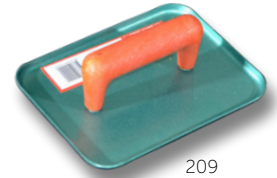

# WOOD FLOATS



FSC CERTIFIED TIMBER

## Masterfinish Wood Floats

These floats feature a long-wearing hardwood face and a lightweight, but tough, orange plastic handle that is adhered to the timber to eliminate marking from screw fixing.



Wood Floats				
Code	Description	Width	Length	Barcode
801	Wood Float	118mm	300mm	9318428178012
802	Wood Float	118mm	380mm	9318428178029
803	Wood Float	118mm	450mm	9318428178036
804	Wood Float	55mm	450mm	9318428178043
824	Wood Float	65mm	600mm	9318428129038







# COVING TROWELS



Used to form a cove where a wall and floor meet. The 201 coving has a traditional use in 'rubbing up' the setting concrete prior to steel trowelling. If the concrete is left with the finish created by the coving trowel, i.e. a more textured finish than a steel trowelled finish, this is known as a coving finish or 'stipple' finish.



201



203



207

Coving Trowels						
Code	Description	Width	Radius	Height	Pack Qty	Barcode
201	Carbon Steel Coving Trowel	150mm	25mm	70mm	6	9318428112016
202	Carbon Steel Coving Trowel	145mm	25mm	32mm	6	9318428112023
203	Carbon Steel Coving Trowel	95mm	12mm	25mm	12	9318428112030
207	Carbon Steel Coving Trowel	190mm	75mm	90mm	6	9318428112078

# MARGIN TOOLS



The 775 and 776 margin tools have a fixed margin of 100 and 150. The 777 margin tool has a grooving bit that adjusts to the desired width of margin between 70-160mm.

Margin Tools				
Code	Description	Width	Margin	Barcode
775	Stainless Steel Fixed Margin Tool	140mm	100mm	9318428147759
776	Stainless Steel Fixed Margin Tool	140mm	150mm	9318428147766
777	Carbon Steel	120mm	70 to 160mm	9318428147773



777





# CONCRETE EDGERS

**MASTER  
FINISH**  
by A.G. Pulie Pty Ltd

Used to trowel a smooth finish to slab edges and produce a smooth face margin to textured or wood float finished external paving. The range encompasses a variety of edge radii and blade widths to suit an extensive range of applications. The blades are formed from carbon and stainless steel.

**MASTER  
FINISH**  
by A.G. Pulie Pty Ltd



402



408



402S



700

## Edging Tools

Code	Description	Radius	Width	Length	Depth	Pack Qty	Barcode
401	Carbon Steel Concrete Edging	5mm	75mm	140mm	12mm	12	9318428144017
402	Carbon Steel Edging Tool	6mm	75mm	140mm	12mm	12	9318428144024
403	Carbon Steel Edging Tool	10mm	75mm	140mm	19mm	12	9318428144031
404	Carbon Steel Edging Tool	5mm	38mm	140mm	12mm	12	9318428144048
405	Carbon Steel Edging Tool	5mm	50mm	140mm	12mm	6	9318428144055
406	Carbon Steel Edging Tool	6mm	100mm	150mm	14mm	6	9318428144062
408	Carbon Steel Edging Tool	19mm	80mm	140mm	19mm	6	9318428144086
410	Carbon Steel Edging Tool	10mm	145mm	230mm	14mm	6	9318428144019
401S	Stainless Steel Edging Tool	5mm	75mm	140mm	12mm	6	9318428144116
402S	Stainless Steel Edging Tool	6mm	75mm	140mm	12mm	6	9318428144123
403S	Stainless Steel Edging Tool	10mm	75mm	140mm	19mm	6	9318428144239
700	Stainless Steel Edging Tool	12mm	150mm	230mm	24mm	12	9318428147001
701	Stainless Steel Edging Tool	25mm	150mm	230mm	24mm	12	9318428147018
702	Stainless Steel Edging Tool	12mm	112mm	175mm	22mm	12	9318428147025
703	Stainless Steel Edging Tool	25mm	112mm	175mm	25mm	12	9318428147032
706	Stainless Steel Edging Tool	10mm	105mm	150mm	14mm	12	9318428147063
708	Stainless Steel Edging Tool	20mm	140mm	200mm	19mm	12	9318428147087
709	Stainless Steel Edging Tool	25mm	220mm	200mm	25mm	6	9318428147094







## Bevel Edger

Used for creating a bevel edge finish on concrete slabs.



Bevel Edgers					
Code	Description	Width	Angle	Bevel	Barcode
413	Carbon Steel Bevel Edger	100mm	45°	25mm	9318428144437
414	Carbon Steel Bevel Edger	125mm	45°	25mm	9318428144345

## V Jointers

Used to form 'dummy' joints in concrete paving. The joint in the concrete reduces the thickness of the paving. If cracking occurs, the crack should be at the line of the 'dummy' joint. The joint should be 1/5 of the slab thickness.



The tools are formed from long-wearing steel and have robust, comfortable handles.

V Jointers					
Code	Description	Width	Depth	Pack Qty	Barcode
301	Carbon Steel Vee Jointer	75mm	10mm	6	9318428123012
304	Carbon Steel Vee Jointer	75mm	19mm	6	9318428123043
302	Carbon Steel Vee Jointer	150mm	12mm	6	9318428123029
312	Carbon Steel Vee Jointer	150mm	20mm	6	9318428123128
315	Carbon Steel Vee Jointer	150mm	25mm	6	9318428123159



## Step Nosing

6" x 2-1/2" 1/2" R Outside Step Tool with Wood Handle

- Made of stainless steel
- Matching Inside Step Tool Available
- Made in the U.S.A

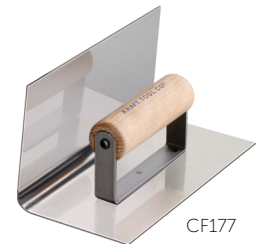

Step Nosing						
Code	Description	Length	Width	Thickness	Radius	Barcode
CF123	Stainless Steel Step Nosing	150mm	64mm	0.06	12mm	9318428145021
CF125	Internal Step	150mm	60mm	0.65	6mm	765139601251
CF177	Internal Step	200mm	100mm	N/A	15mm	9318428105308



## Marble Sheen Trowels

Originally developed for use on marble sheen finishing in swimming pools. The blade has flex due to a short support rib (see tool No. 120A, 121A, 122A and 126A).

A further development from this is a similar trowel with a longer rib for greater rigidity in the blade (see the 'S' series).



Marble Sheen Trowels					
Code	Description	Length	Rib Style	Pack Qty	Barcode
120A	Marble Sheen Finishing Tool	300mm	Short	12	9318428151206
121A	Marble Sheen Finishing Tool	350mm	Short	12	9318428151213
122A	Marble Sheen Finishing Tool	450mm	Short	12	9318428151220
122S	Marble Sheen Finishing Tool	450mm with 330mm Rib	Long	12	9318428151329
122SS	Marble Sheen Finishing Tool	122s with Square Back	Long	12	9318428101829
126A	Marble Sheen Finishing Tool	555mm	Short	12	9318428151268
126S	Marble Sheen Finishing Tool	555mm with 380mm Rib	Long	12	9318428151367
126SS	Marble Sheen Finishing Tool	126S with Square Back	Long	12	9318428151374

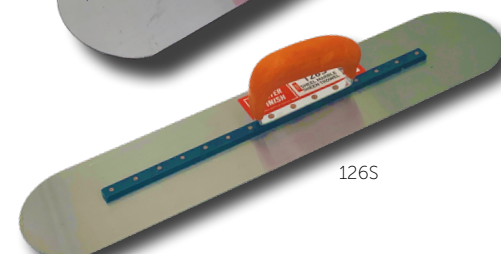



## Magnesium Floats



Used to produce a textured finish smoother than the wood float. A robust and long-wearing tool with a slightly curved or broken-in blade.

Masterfinish Magnesium Floats				
Code	Description	Length	Width	Barcode
MF016PF	Masterfinish Mag Float	16" (406mm)	3-1/4" (83mm)	9318428100495
MF020PF	Masterfinish Mag Float	20" (508mm)	3-1/4" (83mm)	9318428100501



MF016PF



MF020PF



Kraft Magnesium Floats				
Code	Description	Length	Width	Barcode
CF012PF	Magnesium Float	12" (305mm)	3-1/4" (83mm)	765139310153
CF014PF	Magnesium Float	14" (356mm)	3-1/4" (83mm)	765139309591
CF015PF	Extra Wide Mag Float	16" (406mm)	3-1/2" (89mm)	765139309591
CF016PF	Magnesium Float	16" (406mm)	3-1/4" (83mm)	765139309560
CF018PF	Magnesium Float	18" (457mm)	3-1/4" (83mm)	765139323948
CF020PF	Magnesium Float	20" 508mm)	3-1/4" (83mm)	765139309577

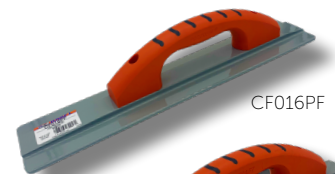

CF016PF



CF020PF

## Round End Magnesium Floats

Magnesium float with rounded ends.



Magnesium Blade Floats				
Code	Description	Length	Width	Barcode
CF076PF	Kraft Round End Mag Float	16" (408mm)	3-1/4" (83mm)	765139309706



CF076PF



## Stainless Steel Safety Step Edger

Cuts four grooves while edging the step. Grooves 3/4" on centre.

Stainless Steel Safety Step Edger				
Code	Description	Radius	Lip Depth	Barcode
CF112PF	Grooved Step Nosing	1/2" (12mm)	1/4" (6mm)	765139348101

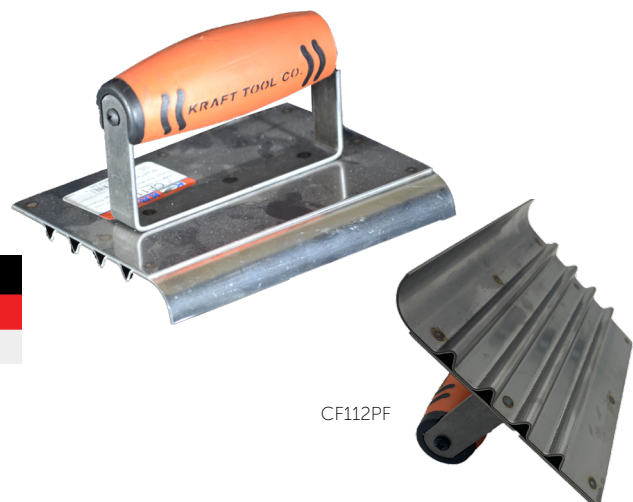

CF112PF



# PLASTIC MARBLE SHEEN FLOAT



The blade is made from 3mm thick low-density white polyethylene and is fixed to a lightweight plastic handle. Originally developed to trowel marble sheen in swimming pools, but now finds a wider use on various wall applications.

### Plastic Marble Sheen Float

Code	Description	Thickness	Barcode
127	Plastic Marble Sheen Float	3mm	9318428151275



127

# WALKING TROWELS

Trowel concrete floors from a standing position. The tubular connection pivots freely to allow the changing angle between the blade and handle to occur. The square end blade allows trowelling up against a wall.

Used in conjunction with the telescopic handle 1076 or clip handle 588. See pages 33 & 34.

### Walking Trowels

Code	Description	Length	Width	End Shape	Barcode
444	Carbon Steel Walking Trowel	440mm	100mm	Round Ends	6 9318428214444
545	Carbon Steel Walking Trowel	600mm	100mm	Round Ends	6 9318428104387
555	Carbon Steel Walking Trowel	600mm	120mm	Round Ends	6 9318428215557
556	Carbon Steel Walking Trowel	600mm	120mm	One Square End	6 9318428215564
557	Stainless Steel Walking Trowel	600mm	100mm	Round Ends	6 9318428215571
558	Stainless Steel Walking Trowel	600mm	100mm	One Square End	6 931842812884
600SS	Stainless Steel Trowel with Aluminium Rib	600mm	100mm	Rounded Ends	6 9318428109597
620SS	Stainless Steel Trowel with Aluminium Rib	600mm	120mm	Rounded Ends	6 9318428112108

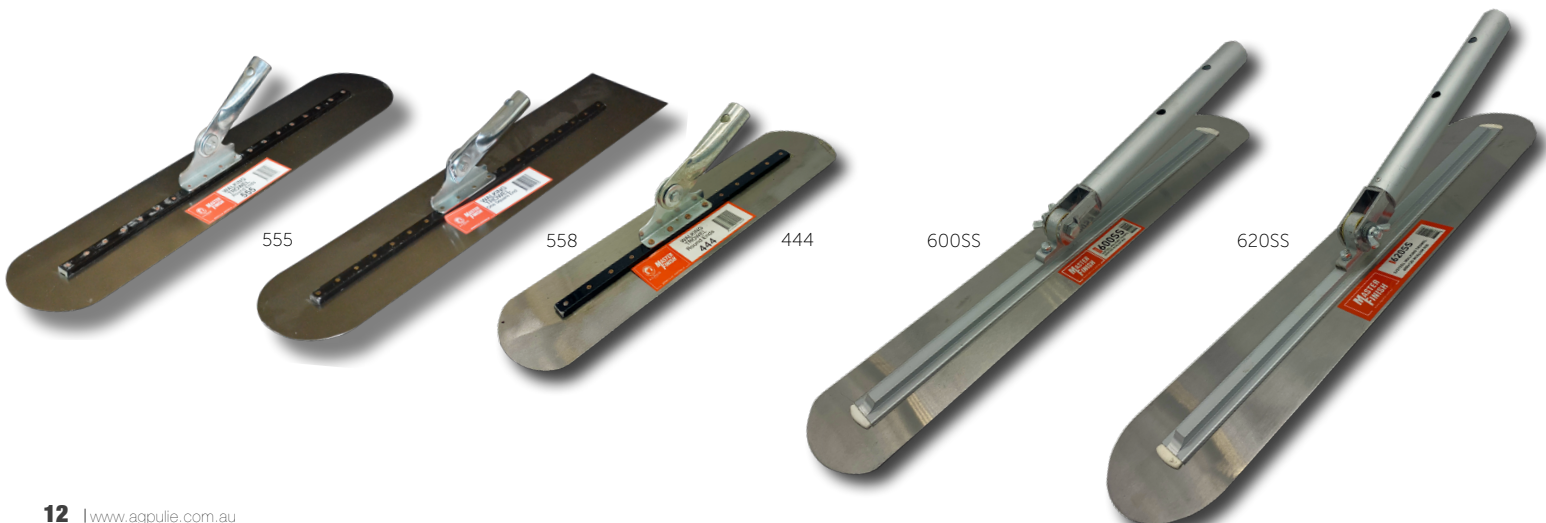



# STANDING BRACKETS

**MASTER  
FINISH**  
by A.G.Pulie Pty Ltd

This bracket may be attached to the handle of tools such as the 302 Groover or the 702 Edger, to allow for fitting to a 1076 or 588 handle. The tools can then be used in positions that are difficult to reach, or simply from a standing position. Tool not included.

## Standing Bracket

Code	Description	Barcode
SB	Standing Bracket	9318428212761



# FRESNO TROWELS

606 - The illustration shows the standard fitting which can be locked at the desired angle. With this fitting the Fresno may also be used as a walking trowel by locking the fitting parallel to the blade. Use with 588 and 1076 poles.

607-609-612 -This Fresno is fitted with a bracket and tilt mechanism as illustrated - used only in a push/pull operation. Use with 588 and 1076 poles, see page 33 & 34.

## Fresno Trowels

Code	Description	Length	Barcode
606	Can be locked at desired angle	600mm	9318428216066
607	Fitted with bracket and tilt mechanism	600mm	9318428216073
609	Fitted with bracket and tilt mechanism	900mm	9318428216097
612	Fitted with bracket and tilt mechanism	1200mm	9318428112309







## Bullfloats

The tilt of the blade is adjustable and controlled by twisting the handle. This enables the operator to change the tilt of the blade (continuously if required) to achieve the optimum finish to the concrete. If the blade lies flat on the slab it leaves a rough finish but will close and fill holes. When the blade is tilted on an angle a smoother finish will result. There is no need to raise or lower the handle, simply twist it for best results.

**USE WITH** 588, 1067, 1076 & MFLH40

Bullfloats			
Code	Description	Length	Barcode
1062	Masterfinish Aluminium Bullfloat	600mm	9318428211627
1063	Masterfinish Aluminium Bullfloat	900mm	9318428211634
1064	Masterfinish Aluminium Bullfloat	1200mm	9318428211641
1065	Masterfinish Aluminium Bullfloat	1500mm	9318428211658
1068	Masterfinish Aluminium Bullfloat	1800mm	9318428211689

1064 - 1200mm



1062 - 600mm

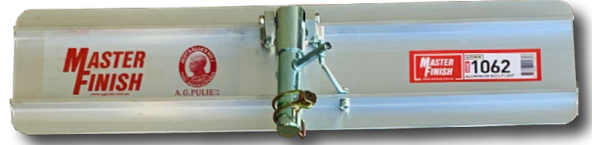

1063 - 900mm



1065 - 1500mm



1068 - 1800mm



## Kraft Bronze Bullfloat Groovers

Use the bullfloat as a groover. Attaches with two thumb screws. Mount as many groover bits as needed. Works on 8" wide bullfloats. Fits the Masterfinish Bullfloat; MF803



Bronze Bullfloat Groover Bits					
Code	Description	Width	Length	Depth	Barcode
CC940	Bronze Bullfloat Groover Bits	1/2" (12mm)	1/4" (6mm)	3/4" (9mm)	765139619409
CC941	Bronze Bullfloat Groover Bits	1/2" (12mm)	1/4" (6mm)	1" (25mm)	765139619416
CC942	Bronze Bullfloat Groover Bits	1/2" (12mm)	1/4" (6mm)	1-1/2" (38mm)	765139619423
CC943	Bronze Bullfloat Groover Bits	1/2" (12mm)	1/4" (6mm)	2" (50mm)	765139619430



CC942

Fresno Groover Bits				
Code	Description	Lip Depth	Barcode	Suits
CC623	Bronze Fresno Trowel Groover Bits	1/2" (12mm)	765139616231	607, 609, 612



CC623

## Bullfloat Groover

Produces a uniform sharp groove in various concrete applications where water drainage and traction are critical.

Magnesium BullFloat Groover						
Code	Description	Width	Length	Depth	Bit Depth	Barcode
CC794-01	Kraft Magnesium Bullfloat Groover	8" (203mm)	36" (914mm)	1/4" (6.35mm)	1/4" (6.35mm)	765139323542



CC794



Bottom View





## Kraft Magnesium Channel Float

Great finishing tool - extra strong, making it ideal for many jobs such as flatwork and paving. Sold without bracket or handle.

Channel Float				
Code	Description	Length	Width	Barcode
CC044-01	Magnesium Channel Float	48" (1219mm)	6" (152mm)	765139615203
CC046SR-01	Magnesium Channel Float	60" (1500mm)	6" (153mm)	765139325966
CC050-01	Magnesium Channel Float	10' (3048mm)	6" (153mm)	765139615227

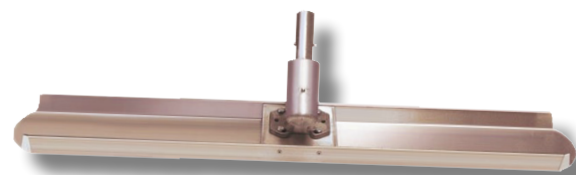

CC046SR

*No Bracket included, use with Kraft brackets and poles*

## Magnesium Bullfloat

Lightweight bullfloat used to level and smooth a large area of concrete before finishing. The float features multiple ribs for extra strength. Designed to be used with 4-hole brackets; CC280, CC296, CC294

Magnesium Bullfloats			
Code	Description	Length	Barcode
MF803-01	Magnesium Bullfloat (Without Bracket)	48" (1219mm)	9318428114942

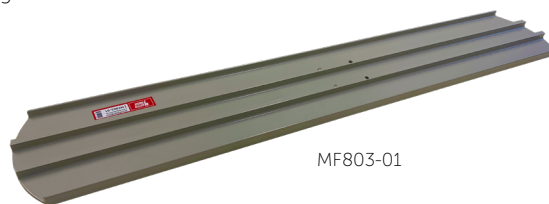

MF803-01

## Kraft Tilt Brackets

Used with Kraft channel floats and fresno

**NOTE:** All brackets can be used with Kraft Pole

Kraft Tilt Brackets				
Code	Description	Fits	Barcode	
CC280	Bronco Tilt	2 or 4 hole metal Bullfloats	765139612806	
CC296	Knucklehead Bracket	2 or 4 hole metal Bullfloats	765139321593	
CC294	Ezy Tilt II	2 or 4 hole metal Bullfloats	765139612943	

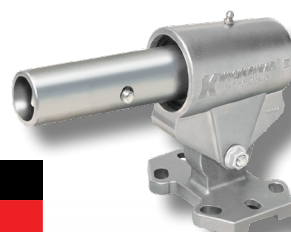

CC296

## Kraft Poles

**CC289SB - CC291SB - CC293SB**

Swaged handles are anodized aluminium which prevents hands turning black from oxidation. Lightweight aluminium button handles for use with Kraft double tilt action float brackets.



**Available in a range of sizes:**

CC289SB - 1.8m, CC293SB - 2.4m and CC291SB - 3m. Handles have a diameter of 1-3/4".

## CC336B

1.8m swaged handles are anodized aluminium which prevents hands turning black from oxidation. Handles can be adapted for use on bullfloats, fresnos, and all long handle type construction tools. Swaged ends nest and snap together with spring lock buttons.

Poles				
Code	Description	Length	Diameter	Barcode
CC289SB	Kraft Aluminum Button Handle	6ft (1.8m)	1-3/4"	765139334227
CC291SB	Kraft Aluminum Button Handle	10ft (3m)	1-3/4"	765139351170
CC293SB	Kraft Aluminum Button Handle	8ft (2.4m)	1-3/4"	765139351217
CC336B	Clip Handle	6ft (1.8m)	1-3/8"	765139326161



## Masterfinish Channel Float

Masterfinish Channel Floats are used in place of traditional bullfloats for flatter floors. The tilt of the blade is adjustable and controlled by twisting the handle. This enables the operator to change the tilt of the blade (continuously if required) to achieve the optimum finish to the concrete. Checked to exact flatness tolerances. Handle not included.

Channel Float				
Code	Description	Length	Width	Barcode
MF712	Masterfinish Channel Float	10' (3048mm)	6" (152mm)	9318428109214

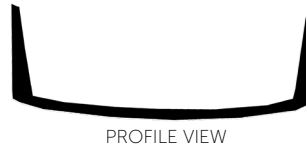
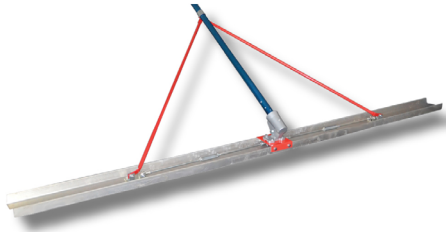

PROFILE VIEW

## Masterfinish Aluminium Check Screed

The Masterfinish Aluminium Check Screed is an early entry restrengthening tool. Used to reduce bumps and fill low spots while the concrete is still plastic. The tilt of the blade is adjustable and controlled by twisting the handle. This enables the operator to change the tilt of the blade (continuously if required) to achieve the optimum finish to the concrete. Handle not included.

Check Screed				
Code	Description	Length	Width	Barcode
MF713	Aluminium Check Screed	10' (3048mm)	4" (102mm)	9318428651508

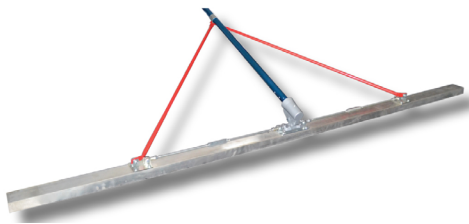

PROFILE VIEW

## Bump Cutters



Super-Flat Bump Cutters cut bumps and fill low areas after the concrete slab has been floated. The tilt of the blade is adjustable and controlled by twisting the handle. This enables the operator to change the tilt of the blade (continuously if required) to achieve the optimum finish to the concrete. Handle not included with MF714.

Bump Cutters					
Code	Description	Length	Width	Thickness	Barcode
MF714	Masterfinish Aluminium Bump Cutter	10' (3048mm)	4" (102mm)	2" (51mm)	9318428115482

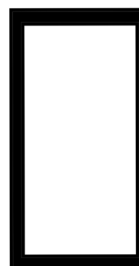
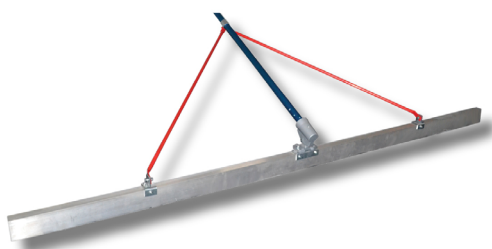

PROFILE VIEW

*All tools on this page use handles on page 15*





## Thickness Gauge



These self-adjusting gauge rakes have been used for many years. They allow you to achieve a reasonably level depth when installing more cementitious materials and move more easily over rougher surfaces.

**NOTE:** Handle not included

Thickness Gauge				
Code	Description	Size	Made to fit	Barcode
TG600	Thickness Gauge	600mm	Timber Handles	9318428116007
TG1000	Thickness Gauge	1000mm	Timber Handles	9318428110005

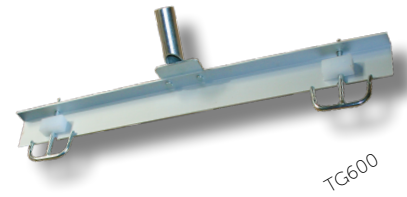

## Stand Up Smoother

**NOTE:** Handle not included

This tool is used in an upright position. The Stand Up Smoother maximises installation speed while being very user friendly. Used for smoothing floor levelling compounds.

Stand Up Smoother			
Code	Description	Blade Length	Barcode
VT600	Carbon Steel Stand Up Smoother	600mm	9318428100563



## Squeegee

**NOTE:** Includes timber handle

Squeegee			
Code	Description	Length	Barcode
SGE626	Squeegee (Includes timber handle)	626mm	9318428106664
SGE626-B	Replacement squeegee rubber	626mm	9318428106671

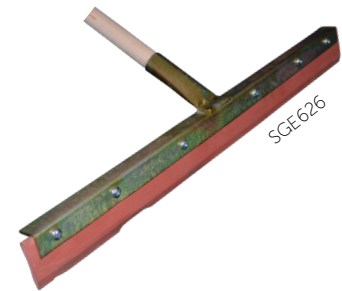

## Mesh Roller

Diamond Patterned Safety Roller gives a rough, skid resistant finish to concrete ramps. Perfect for wheelchair or loading walkways where a non-skid surface is a must. Roller is 5" in diameter and made of tough expanded steel diamond mesh. Handle bracket accepts threaded 1-3/4" bullfloat extension handles. Fits CC289SB, CC291SB and CC293SB Kraft poles, see page 15.



*Mesh rollers are used to depress aggregate for ease of finish*

Concrete Mesh Roller			
Code	Description	Length	Barcode
CC948B	Mesh Roller	18" (457mm)	765139613780
MF952	Mesh Roller	36" (914mm)	765139610857



## Salt Roller Tamps

Make small decorative impressions in concrete using rock salt. The 30" long roller moves over the concrete forcing the rock salt into the concrete. The rock salt can be rinsed and worn away leaving just a speckled impression on the surface.

Salt Roller Tamps			
Code	Description	Length	Barcode
CC957	Decorative Salt Roller	750mm	765139335774

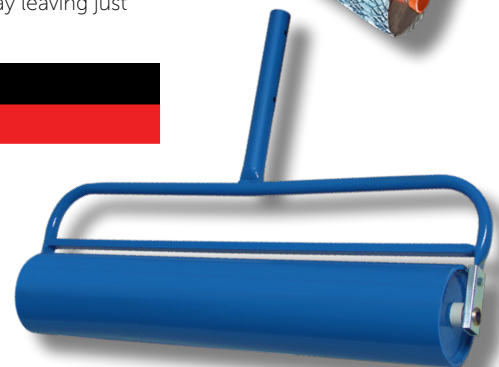



# FINISHING BROOMS

**MASTER  
FINISH**  
by A.G.Pulie Pty Ltd

Timber brooms are made with high quality hair and fibre bristles. Made to fit 588 and 1076.



## Finishing Brooms

Code	Description	Length	Bristles	Colour	Barcode
1572	Hair and fibre bristle timber broom	600mm	Standard/Fine	Black	9318428295726
1573	Hair and fibre bristle timber broom	750mm	Standard/Fine	Black	9318428295733
1574	Hair and fibre bristle timber broom	900mm	Standard/Fine	Black	9318428295740



# FINISHING BROOMS

**MASTER  
FINISH**  
by A.G.Pulie Pty Ltd

Aluminium finishing brooms made with high quality nylon and genuine horse hair bristles. Fitted with a heavy-duty aluminium bracket that can rotate 180 degrees.



## Finishing Brooms

Code	Description	Length	Bristles	Barcode
MF-1974	Nylon bristle aluminium broom	900mm	Nylon	9318428114263
MF-1974HH	Horse hair bristle aluminium broom	900mm	Horse hair	9318428114270





## Kerb and Gutter Hand Tools

Kerb and Gutter Tools		
Code	Description	Barcode
KGT	Kerb and Gutter Profile Trowel	9318428221985
RK	Roll Kerb Trowel (Pair)	9318428102208
KGCT	Kerb and Gutter Crossing Trowel	9318428221978
KGC	Kerb Coving Trowel	9318428221954
SF	Splayed Kerb Tool	9318428222203
KGE	Kerb Nosing Trowel	9318428221930

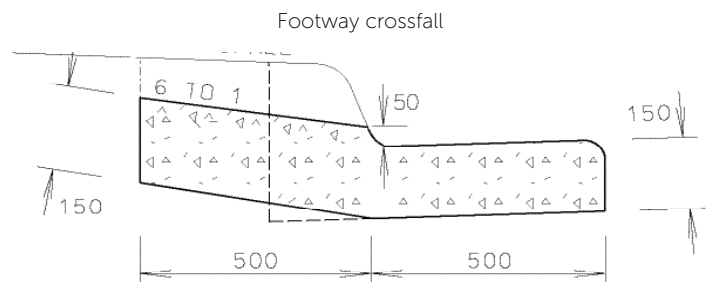
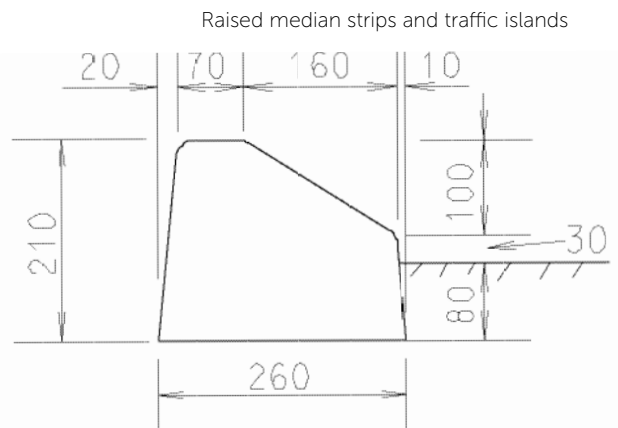
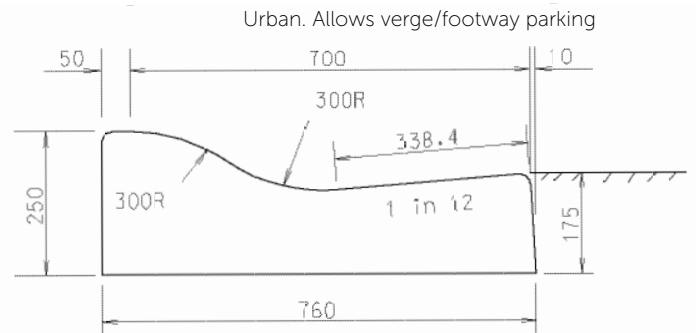
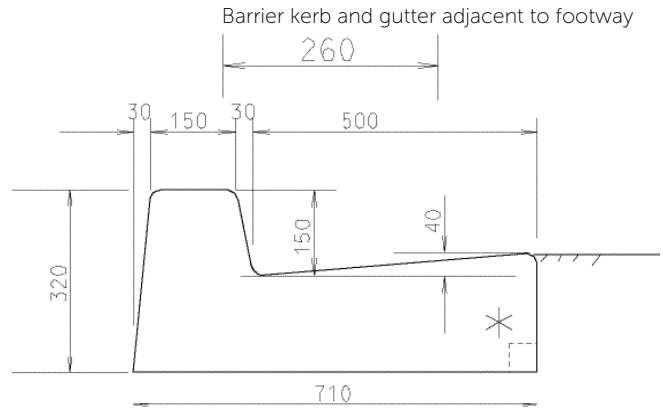
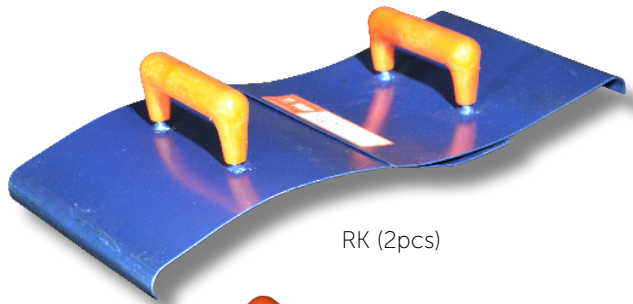



## Dish Drain and Coving Tools

Used to form dish drains and coves in concrete.



### Dish Drain and Coving Tools

Code	Description	Radius	Width	Barcode
206	Dish Drain Trowel	50mm	105mm	9318428112061
466	Channel Trowel	75mm	125mm	9318428114669



466

## Float Hook & Glove Clip

Float hooks clip to belt. Holds hand floats and other tools.



### Float Hook

Code	Description	Pack Qty	Barcode
MF011	Float Hook	24	9318428100358
MF012	Glove Clips	50	9318428103281



MF012

MF011

## Pool Trowels

Forged aluminium shanks. The longer shank creates more stability in the trowel blade whereas a small shank will allow for more flexibility. Rounded edges prevent surface gouging.



### Pool Trowels

Code	Description	Length	Width	Shank	Barcode
CF272BPF	Blue Steel Short Shank Pool Trowel	14" (356mm)	3" (76mm)	6" (152mm)	765139306071
CF274BPF	Blue Steel Short Shank Pool Trowel	10" (254mm)	3" (76mm)	3" (76mm)	765139306170
CF277BPF	Blue Steel Short Shank Pool Trowel	14" (356mm)	4" (102mm)	6" (152mm)	765139100389

Other Sizes Available



CF272BPF

## Walking Tools

These are dedicated walking floats, edgers and jointers and are made to be used with either a 1076 or 1067 telescopic pole or a 588 clip handle. See page 33 & 34



### Walking Tools

Code	Description	Length	Width	Depth	Radius	Barcode
700W	Carbon Steel Walking Edger	230mm	150mm	24mm	12mm	9318428147100
708W	Carbon Steel Walking Edger	200mm	140mm	19mm	20mm	9318428147117
302W	Carbon Steel Walking Vee Jointer	175mm	150mm	12mm	N/A	9318428123036
312W	Carbon Steel Walking Vee Jointer	175mm	150mm	20mm	N/A	9318428132135
219W	Carbon Steel Walking Float	150mm	380mm	N/A	N/A	9318428212198
209W	Stainless Steel Walking Float	160mm	210mm	N/A	N/A	9318428212099



312W



708W



219W



## Floor Scrapers

Cleans and shaves all types of material from concrete and wood surfaces. Great for concrete form cleaning. Built with spring steel blades which are replaceable.

Floor Scraper				
Code	Description	Blade size	Pack Qty	Barcode
LHS	Heavy Duty Floor scraper	190mm	3	9318428221459
FS150	Floor scraper	150mm	3	9318428221428
FS200	Floor scraper	200mm	3	9318428993509
FS300	Floor scraper	300mm	3	9318428221466
FS356T	356mm Floor Scraper with Timber Handle	356mm	1	9318428 106657
FS500	Floor Scraper	500mm	3	9318428112405

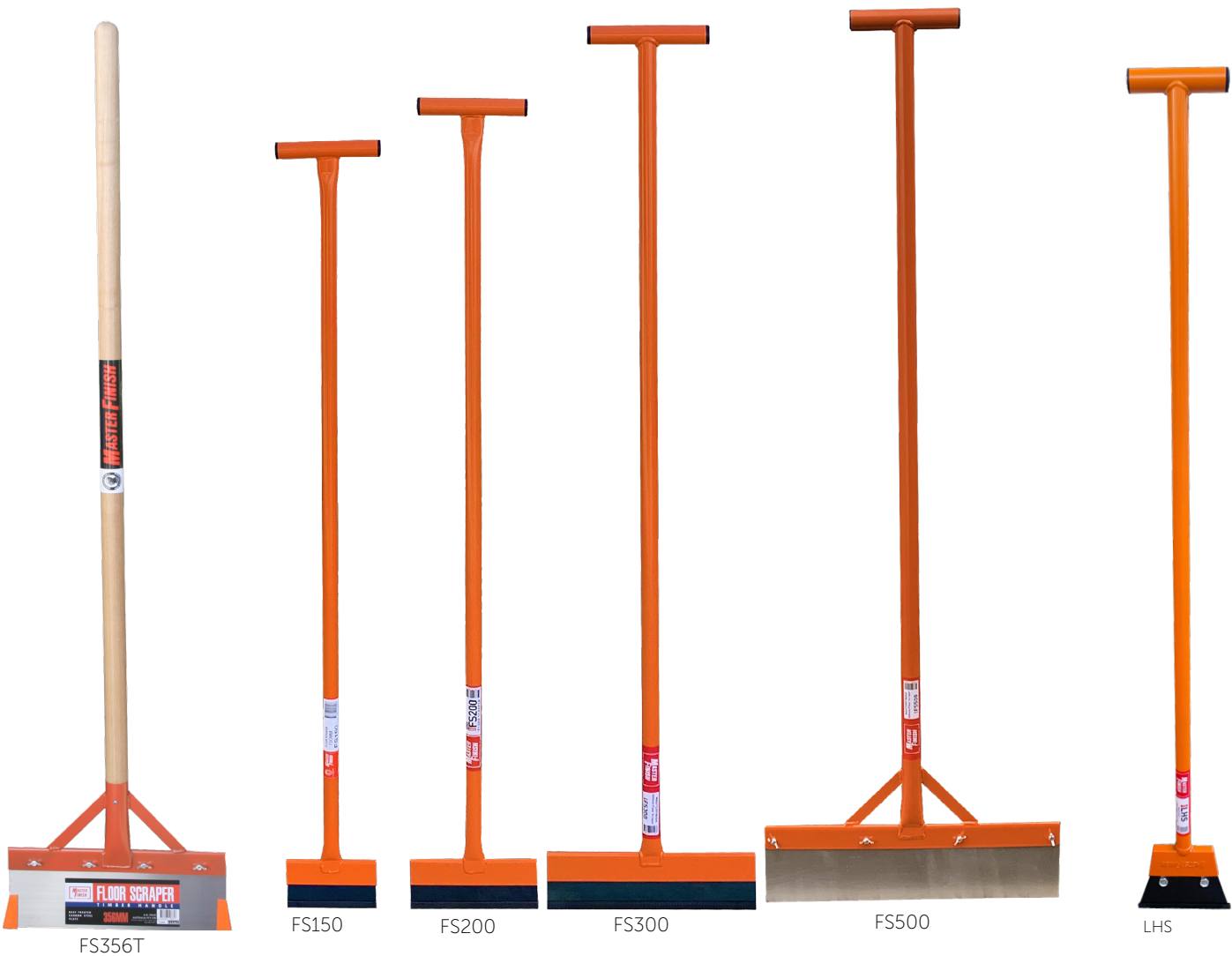

Replacement Floor Scraper Blades				
Code	Description	Blade size	Pack Qty	Barcode
LHS B7	Replacement blade for LHS	190mm	1 for each size	9318428221435
FS150B	Replacement blade for FS150	150mm	1 for each size	9318428110104
FS200B	Replacement blade for FS200	200mm	1 for each size	9318428110111
FS300B	Replacement blade for FS300	300mm	1 for each size	9318428110128
FS356B	Replacement blade for FS356T	356mm x 127mm	1 for each size	9318428106725
FS500B	Replacement blade for FS500	500mm	1 for each size	9318428113198





## Shifting Tools

Shovels				
Code	Description	Length	Pack QTY	Barcode
EMYSL	Square Mouth Shovel	1040mm	6	9318428111446
EMOSL	Concreter's Shovel	1100mm	6	9318428111439
EMHSL	Concreter's Shovel	1200mm	6	9318428111453
EMLOSL	Brickies' Shovel	1500mm	6	9318428111460

## All-Steel Concrete & Brickies'



**Square Mouth Shovel**  
1040mm  
Code: EMYSL



**Concreter's Shovel**  
1100mm  
Code: EMOSL



**Concreter's Shovel**  
1200mm  
Code: EMHSL

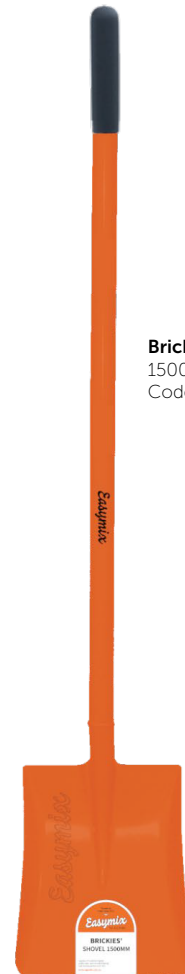

**Brickies' Shovel**  
1500mm  
Code: EMLOSL





## Shifting Tools

### Landscaping & Trades

The new Easymix range features a complete range of landscaping and general trades shifting tools so you can provide for a complete range of your customers needs.

- Steel-core fiberglass handles
- Comfortable grips
- Durable heavy-gauge recycled steel
- Lightweight & tough



**Post Hole Shovel**  
190 x 1610mm  
Code: EMFPH



**Shifting Shovel**  
250 x 1610mm  
Code: EMFSS



**Plumbers' Shovel**  
195 x 1040mm  
Code: EMFPS



**Trenching Shovel**  
110 x 1610mm  
Code: EMFTS



**Landscapers' Rake 18T**  
463 x 1570mm  
Code: EMFNR



**Landscapers' Rake 36T**  
900 x 1800mm  
Code: EMLR36T

## Landscaping Rakes

Shovels & Rakes					
Code	Description	Length	Pack QTY	Handle	Barcode
EMFPH	Post Hole Shovel	190 x 1610mm	6	Fibreglass	9318428111484
EMFSS	Shifting Shovel	250 x 1610mm	6	Fibreglass	9318428111477
EMFPS	Plumbers' Shovel	195 x 1040mm	6	Fibreglass	9318428111491
EMFTS	Trenching Shovel	110 x 1610mm	6	Fibreglass	9318428111507
EMFNR	Landscapers' Rake 18T	463 x 1570mm	6	Fibreglass	9318428111521
EMLR36T	Landscapers Rake 36T	900 x 1800mm	6	Fibreglass	9318428111354



## Concrete Rakes

Rakes and placers have a variety of applications and some are dual purpose.

The MasterFinish aluminium placer rakes come in 3 styles - push, pull and double-sided. T

These well-constructed rakes make spreading concrete easier.

**MASTER  
FINISH**  
by A.G. Pulle Pty Ltd

**#1**  
selling  
concrete rake  
in Australia

**#1**  
selling  
concrete rake  
in QLD



MF999



MF965



MFR500



R600R



CC010



### Concrete Rakes

Code	Description	Length	Width	Handle Length	Barcode
MF999	Aluminium concrete rake with profile for pulling concrete	500mm	100mm	1500mm	9318428101577
MF965	Aluminium concrete rake with a formwork hook and profile for pushing concrete	500mm	110mm	1500mm	9318428109658
R600R	Aluminium concrete rake with profile for both pushing and pulling concrete	500mm	100mm	1600mm	9318428100723
MFR500	Aluminium concrete rake with a profile for pushing	500mm	110mm	1500mm	9318428122284
CC010	Kraft concrete rake with a timber handle	22-1/2"	127mm	1400mm	765139322668





# KNEE BOARDS



The kneeling boards are multipurpose boards and are designed to make kneeling easier. Perfect for concreters and flooring contractors, mechanics and gardeners alike.

## Ideal use for

- Concrete Finishing
- Tile & Carpet Laying
- General Maintenance
- Plumbing & Electrical
- Lawn & Garden
- Auto Repair



QUANTITY OF TEN (10)

### Kneeling Boards

Code	Description	Pack Qty	Barcode
MFKB	Masterfinish EPE Foam Kneeling Board	10	9318428101713





## MF Brick Trowels

MF Brick Trowels						
Code	Description	Length (mm)	Width	Shoulder Style	Pack Qty	Barcode
MFWLON-F	Wide London Brick Trowel - <b>FULLY FORGED</b>	305	142	London Profile	4pcs	9318428112375
MFPHIL-F	Philadelphia Brick Trowel - <b>FULLY FORGED</b>	305	148	Philadelphia Profile	4pcs	9318428112368



MFWLON-F

MFPHIL-F



## Brick Trowels - W. ROSE Brick Trowels



Brick Trowels						
Code	Description	Length	Width	Shoulder Style	Pack Qty	Barcode
RO110-12SH	Rose Philadelphia Brick Trowel	12" (305mm)	5-9/16" (141mm)	Square	6	765139319903
RO112-12SH	Rose London Brick Trowel	12" (305mm)	5-13/16" (147mm)	Round	6	765139310757
RO310-12	Rose Philadelphia Brick Trowel Leather Handle	12" (305mm)	5-9/16" (141mm)	Square	6	765139700558
RO312-12	Rose London Brick Trowel Leather Handle	12" (305mm)	5-13/16" (147mm)	Round	6	765139700626
RO116-13SH	Rose Narrow London Brick Trowel	13" (330mm)	5-3/8" (137mm)	Round	6	765139311075



Narrow London



Wide London



Philadelphia

## Gauge Trowels

Carbon steel blade is ground for flexibility. Perfect for mixing or transferring material. Fitted with a soft grip handle.

Gauge Trowels					
Code	Description	Length	Width	Carton qty	Barcode
T963-7	Gauging Trowel	178mm	85mm	6	9318428100310
T963-8	Gauging Trowel	203mm	90mm	6	9318428100327

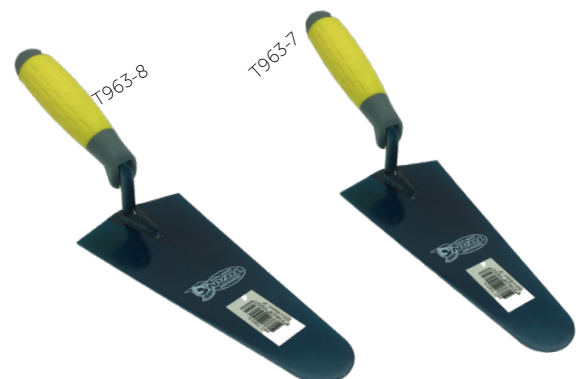



## Plasterer's Hawk

Plasterer's hawks are made with a light but tough aluminium plate, a screw in plastic handle and a sponge hand cushion.



1038

Plasterer's Hawks				
Code	Description	Width	Pack Qty	Barcode
1038	MF Aluminium Plasterer's Hawk	300mm	1	9318428181388
1039	MF Aluminium Plasterer's Hawk	330mm	1	9318428181395
1040	MF Aluminium Plasterer's Hawk	400mm	1	9318428181401

## Plasterer's Nosing

Plasterer's internal and external corner tools have a stainless steel blade formed to the traditional pencil round.



1033

Plasterer's Nosing		
Code	Description	Barcode
1030	Stainless Steel Plasterer's External Edging Tool	9318428181234
1033	Stainless Steel Plasterer's Internal Edging Tool	9318428181333



## Sponge Floats

1155 Sponge foam float features a lightweight plastic handle and aluminium backing plate.  
1156 Foam float has the additional feature of a perforated aluminium backing plate for ease of cleaning the foam after use.



1155

Sponge Floats					
Code	Description	Length	Width	Pack Qty	Barcode
1155	Sponge Foam Float	325mm	135mm	1	9318428181159
1155R	Replacement foam for 1155	325mm	135mm	1	9318428181142
1156	Foam Float with perforated back plate	325mm	135mm	1	9318428181166



1156

## Jumbo Utility Brush

This red handled utility brush is a must for any professional. Long-wearing, white tampico fibres can be used on masonry, brick, tile and stone. A truly versatile brush.



MF-JUB

Jumbo Utility Brush				
Code	Description	Length	Width	Barcode
MF-JUB	Jumbo Utility Brush	6-1/2" (165mm)	2" (50mm)	9318428114287

## DTM Splatter Gun

Ideal for use on a variety of surfaces, including textured materials such as stucco render and exterior cement. Easy to use tool, made in Italy with a brass plated hand crank.

Splatter Gun			
Code	Description	Weight	Barcode
505.7	DTM Splatter Gun	1.5kg	9318428103991
505.7R	Replacement comb roller		9318428114676
505.7C	Replacembent combs		9318428115895



505.7



505.7R

MADE IN ITALY





## Excel Tools

### Excel Vee Jointer



*Sold in WA and SA only.*

C1



C1A



Used to form 'dummy' joints in concrete paving. The joint in the concrete reduces the thickness of the paving. If cracking occurs, the crack should be at the line of the 'dummy' joint. The joint should be 1/5 of the slab thickness. Blades are formed from stainless steel.

#### Excel Jointer

Code	Description	Width	Length	Depth	Pack Qty	Barcode
C1	Vee Jointer	90mm	150mm	13mm	6	9318428102352
C1A	Long Walking Vee Jointer	90mm	300mm	12mm	6	9318428102369

C4



### Excel Oblong Non-Skid Floor Float

*Sold in WA and SA only.*

SOLD IN WA AND SA ONLY - Used to 'rub up' a concrete floor prior to steel trowelling or to work in coloured dry shake. They produce a textured finish smoother than a wood float, which suits outdoor paving applications. The trowels feature a long-wearing robust steel blade that is turned up all round. Blades are formed from stainless steel.

#### Excel Non-Skid Float

Code	Description	Width	Length	Pack Qty	Barcode
C4	Oblong Non-Skid Floor Float	115mm	311mm	6	9318428102376

### Excel Edgers

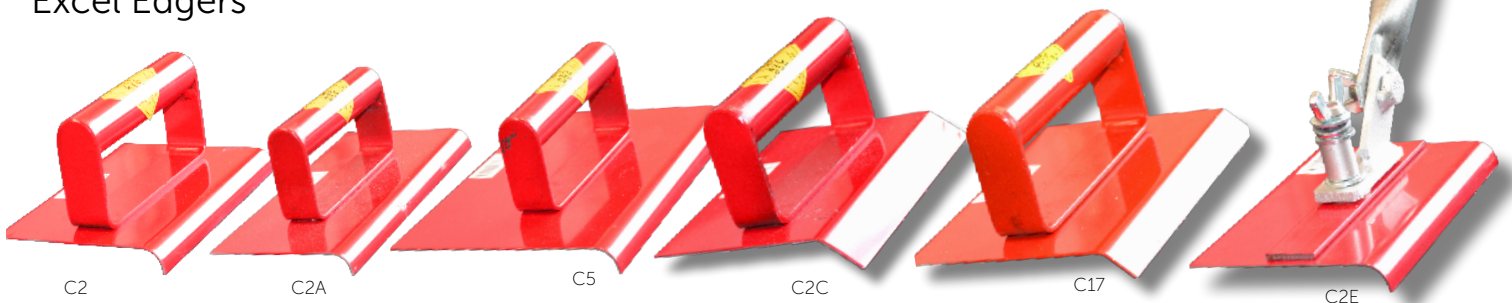

C2

C2A

C5

C2C

C17

C2E

Used to trowel a smooth finish to slab edges and produce a smooth face margin to textured wood float finished external paving. Blades are formed from stainless steel.

*Sold in WA and SA only.*

#### Excel Edgers

Code	Description	Width	Length	Lip	Radius/Angle	Pack Qty	Barcode
C2	Edger	115mm	150mm	13mm	10mm	6	9318428102291
C5	Large Edger	155mm	205mm	14mm	11mm	6	9318428102307
C2E	Long Walking Edger	115mm	300mm	13mm	10mm	6	9318428102314
C2A	Special Edger	115mm	200mm	13mm	10mm	6	9318428102321
C2C	Bevel Edger	115mm	150mm	24mm	135°	6	9318428102338
C17	Bevel Edger	115mm	150mm	17mm	135°	6	9318428102345





# STRAIGHT EDGE

Light-weight accurate straight edge - measures 70x19. Uses include ruling cement render, tiling and as a general construction straight edge. Fitted with end plugs and powder-coated for ease of clean up. Also available in a milled finish.

**MASTER  
FINISH**  
by A.G. Pulie Pty Ltd



P12  
**Powdercoated Green  
Aluminium Straight Edge**

P12P  
**Milled Finish  
Aluminium  
Straight Edge**

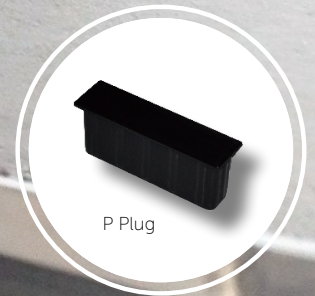

P Plug

## Straight Edges

Code	Description	Length	Barcode
P12	Powdercoated Green Aluminium Straight Edge	1200mm	9318428199123
P15	Powdercoated Green Aluminium Straight Edge	1500mm	9318428199154
P18	Powdercoated Green Aluminium Straight Edge	1800mm	9318428199185
P21	Powdercoated Green Aluminium Straight Edge	2100mm	9318428199215
P24	Powdercoated Green Aluminium Straight Edge	2400mm	9318428199246
P27	Powdercoated Green Aluminium Straight Edge	2700mm	9318428199277
P30	Powdercoated Green Aluminium Straight Edge	3000mm	9318428199307
P36	Powdercoated Green Aluminium Straight Edge	3600mm	9318428199369
P12P	Milled Finish Aluminium Straight Edge	1200mm	9318428198126
P15P	Milled Finish Aluminium Straight Edge	1500mm	9318428198157
P18P	Milled Finish Aluminium Straight Edge	1800mm	9318428198188
P21P	Milled Finish Aluminium Straight Edge	2100mm	9318428198218
P24P	Milled Finish Aluminium Straight Edge	2400mm	9318428198249
P27P	Milled Finish Aluminium Straight Edge	2700mm	9318428198270
P30P	Milled Finish Aluminium Straight Edge	3000mm	9318428198300
P36P	Milled Finish Aluminium Straight Edge	3600mm	9318428198362
P Plug	Straight Edge End Plug	N/A	9318428199116



# CLAMP HANDLE SCREED

**MASTER FINISH**  
by A.G. Pulie Pty Ltd

'Clamp-on' style handle, which may be reversed to the working face for second use. Fitted with end plugs and powder-coated for ease of clean up.

**Australia's Original No.1 Selling Screed.**



## Screeds

Code	Description	Length	Handle	Barcode
C12	Aluminium Concrete Screed	1200mm	Standard	9318428193121
C15	Aluminium Concrete Screed	1500mm	Standard	9318428193152
C18	Aluminium Concrete Screed	1800mm	Standard	9318428193183
C21	Aluminium Concrete Screed	2100mm	Standard	9318428193213
C24	Aluminium Concrete Screed	2400mm	Standard	9318428193244
C27	Aluminium Concrete Screed	2700mm	Standard	9318428193275
C30	Aluminium Concrete Screed	3000mm	Standard	9318428193305
C36	Aluminium Concrete Screed	3600mm	Standard	9318428193367
C12L	Aluminium Concrete Screed W/Level	1200mm	Level Vial Handle	9318428194128
C15L	Aluminium Concrete Screed W/level	1500mm	Level Vial Handle	9318428194159
C18L	Aluminium Concrete Screed W/level	1800mm	Level Vial Handle	9318428194180
C21L	Aluminium Concrete Screed W/level	2100mm	Level Vial Handle	9318428194210
C24L	Aluminium Concrete Screed W/level	2400mm	Level Vial Handle	9318428194241
C27L	Aluminium Concrete Screed W/level	2700mm	Level Vial Handle	9318428194272
C30L	Aluminium Concrete Screed W/level	3000mm	Level Vial Handle	9318428194302
C36L	Aluminium Concrete Screed W/level	3600mm	Level Vial Handle	9318428194364
1080H	Screed Handle	N/A		9318428191080
LVH	Screed Handle With Level Vial	N/A		9318428102598
C Plug	End plug for C screed	N/A		9318428193114
1080CC	Clamped handle screed bracket	N/A		9318428102864
C600	Aluminium Concrete Screed	600mm	Standard	9318428109986
C800	Aluminium Concrete Screed	800mm	Standard	9318428109993



# FIXED HANDLE SCREED



Availability *Queensland only*

**MASTER FINISH**  
by A.G.Pulie Pty Ltd

Traditional 50x36mm aluminium box section with one radius and one sharp cutting edge. The handle is fixed to the top of the screed. Fitted with end plugs and powder-coated for ease of clean up.



## Screeds

Code	Description	Length	Barcode
F12	Aluminium Fixed Handle Screed	1200mm	9318428196122
F15	Aluminium Fixed Handle Screed	1500mm	9318428196153
F18	Aluminium Fixed Handle Screed	1800mm	9318428196184
F21	Aluminium Fixed Handle Screed	2100mm	9318428196214
F24	Aluminium Fixed Handle Screed	2400mm	9318428196245
F27	Aluminium Fixed Handle Screed	2700mm	9318428196276
F30	Aluminium Fixed Handle Screed	3000mm	9318428196306
F36	Aluminium Fixed Handle Screed	3600mm	9318428196368
F Plug	End Plug for F Screed	N/A	9318428196115





# POLES & ACCESSORIES

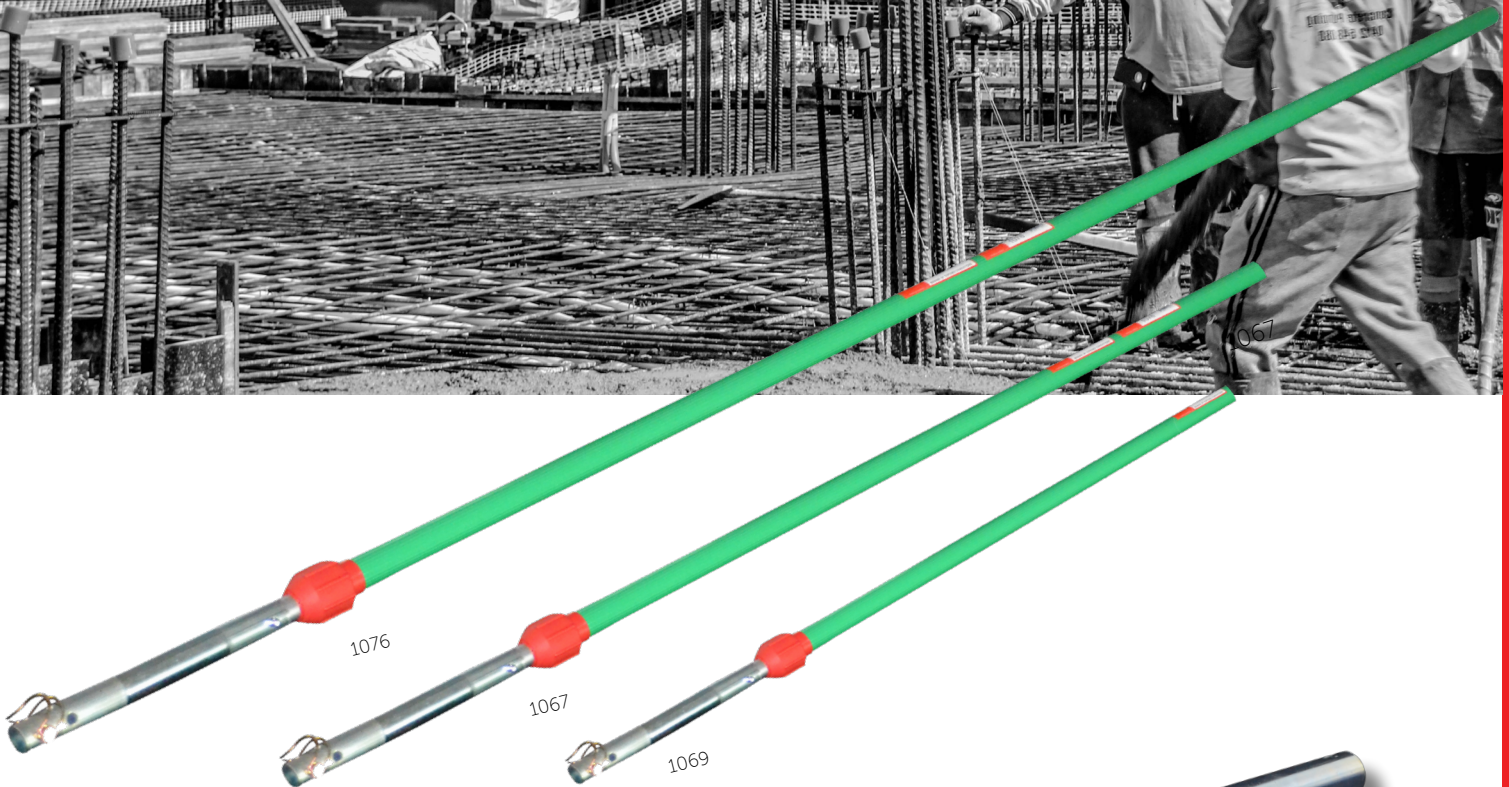

Widely used for many floating and finishing jobs, enabling the work to be achieved from a standing position, external from the concrete slab. The inside tube is grooved.

A pin penetrates this groove. This allows the twisting action the operator applies to the handle to be transferred to the floor. The handle length is locked by lightly twisting the collet nut.

The 1076 can extend from 2.75 to 5m and the 1067 can extend from 1.23m to 2.43m. The handle also features removable clip-on steel tube adaptor (part No. 1076E).

This allows the operator to unclip the handle from the tool for cleaning, storage or to fit to another tool.

Additional adaptor tubes (1076E) may be purchased.



1076P-4



1076S-4

Poles			
Code	Description	Length	Barcode
1067	Telescopic Handle Half Length	1.23m to 2.43m	9318428101546
1069	Telescopic Handle	0.9-2.1m	9318428112696
1076	Telescopic Handle	2.75m to 5m	9318428211665
1076E	Swaged Adaptor	N/A	9318428101768
1076P-4	4 Pack 1076 Pin & Clamp	N/A	9318428993400
1076S-4	4 Pack Spring Clips	N/A	9318428103311





## MASTERFINISH CLIP TOGETHER POLES

### MFLH40

The MasterFinish MFLH40 spring clip allows user to connect multiple poles together to achieve the desired length.



#### Poles

Code	Description	Length	Diameter	Barcode
MFLH40	Clip Together Pole	1.83m	35mm	9318428112238



### 588

The aluminium tube is fluted to enhance grip. The inserted end tube is zinc plated steel, swaged down to fit neatly on the shaft of a bullfloat, walking trowel, or broom bracket. Three or four of these handles may be aligned together to give a reach of 6 to 8 metres.

#### Poles

Code	Description	Length	Barcode
588	Multi Fit Clip Handle	2m	9318428215588



## Magnesium Featheredge

Made from lightweight but durable magnesium alloy. Special "H" extrusion shape allows for comfortable finger grip. Commonly used in the plastering, render and shotcrete trades.

#### Magnesium Featheredge

Code	Description	Length	Barcode
MF004	Magnesium Featheredge	1200mm	9318428115901
MF006	Magnesium Featheredge	1800mm	9318428115918
MF008	Magnesium Featheredge	2400mm	9318428115925

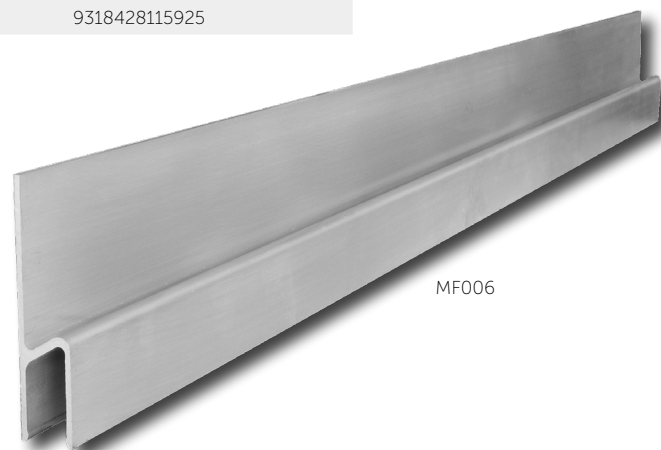

MF006



## Rub Bricks

Fluted silicon carbide rub bricks with a contoured handle to minimize fatigue. Preferred by finishers for fast and easy concrete smoothing and dressing down.



MF282

### Carborundum Rubbing Brick

Code	Description	Length	Pack Qty	Thickness	Barcode
MF282	60 Grit Rub Brick	152mm	1	76mm	9318428115970
MF283	20 Grit Rub Brick	152mm	1	76mm	9318428115987

## Adhesive Spreaders

QTF has a 10mm square tooth for applications requiring a thick bed of adhesive such as quarry tiles.



### Adhesive Spreaders

Code	Description	Tooth Style	Pack Qty	Thickness	Barcode
QTF	Carbon Steel Adhesive Spreaders	10mm square tooth	1	1.6mm	9318428222005

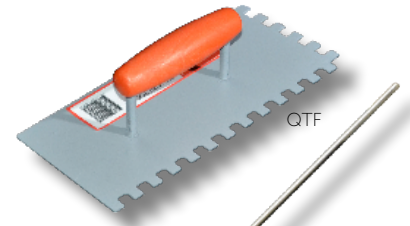

QTF

## Mixer Paddles

Mixer paddles are designed to mix a wide variety of materials from paint to cement.



### Mixer Paddles

Code	Description	Diameter	Pack Qty	Length	Barcode
MIXER	Mixer Paddles	120mm	1	600mm	9318428101737

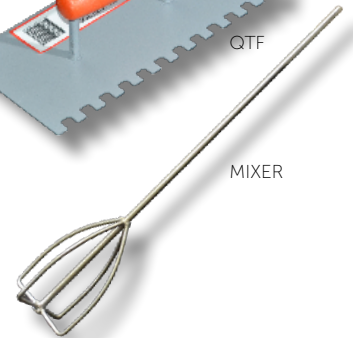

MIXER

## Heavy Duty Pry Bar

All purpose tool ideal for prying formwork and other construction jobs. Specially designed 3" wide blade angle and hardened steel claw make for easy prying.

### Masterfinish Pry bars

Code	Description	Length	Barcode
MF-630	Heavy-Duty Pry Bar - Large	1440mm	9318428114935
MF-631	Heavy-Duty Pry Bar - Small	1220mm	9318428114966



MF-630

MF-631

## Concrete Sliders

These knee skis are made of lightweight, tough heavy-duty fibreglass, making them easy to use and clean. One size fits all. The knee skis allow you to get onto the concrete earlier as they create a larger surface area for your weight to be spread over.



### Knee Boards

Code	Description	Length	Weight	Barcode
CC153	Fibreglass Kneeboard	30" (762mm)	10kgs	765139611533

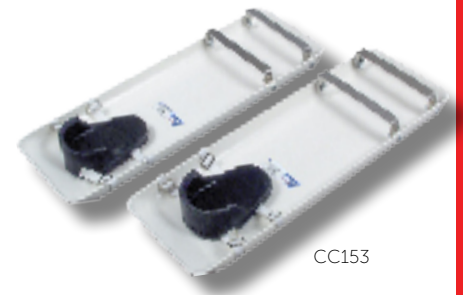

CC153

## Gunite Shoes

Gunite shoes allow you to work on gunite, epoxy, or sealers with ease of movement. They also protect the material from footprints and bring air bubbles out of the application.



### Gunite Shoes

Code	Description	Spike Length	Size	Barcode
HC177	Flexible Plastic Gunite Shoe	3/4" (19mm)	One Size Fits All	765139454109
HC178	Hard Plastic Gunite Shoe	1-1/2" (38mm)	One Size Fits All	765139335736



HC178





# KNEE PADS



Offering the perfect combination of protection and comfort that other kneepads just can't match. They are so comfortable that they can be worn with shorts. The quick-fastening front-strap design and "clear zone" behind the knee eliminates rash or pinching that usually occurs from the inferior designs that use buckles, straps, or outdated fastening methods.

**They are constructed of 100% washable premium grade SBR neoprene.**



One of a kind knee-pad shape provides the ultimate in strength, comfort and adjustability.

Large enough to fit a professional contractor. Heavy duty closed cell foam cushion won't puncture or leak like gel pads.

- Comfortable Design
- Professional Grade
- Single Front Fastening Strap
- Premium Grade Neoprene
- Non-Marring
- Washable
- Durable



## DISPLAY BOX

MINIMUM QTY OF SIX (6)

### Knee Pads

Code	Description	Pack Qty	Barcode
MF-KNEE	Soft Knee Pads	6	9318428112900





# GLOVES

**MASTER  
FINISH**  
by A.G.Pulie Pty Ltd

Masterfinish trade-tough contractors gloves are nitrile coated and perfect for landscaping, automotive work, concreting, carpentry, electrical work, gardening and manufacturing.

Sold in packs of five.



MFNGO-5  
**LARGE**



MFNGOXL-5  
**EXTRA  
LARGE**



## Work Gloves

Code	Description	Size	Pack Qty	Min Order	Barcode
MFNGO-5	Work Gloves	Large	5	48x5 pack	9318428150001
MFNGOXL-5	Work Gloves	X-Large	5	48x5 pack	9318428 110135





# MF BUCKET PUMP

**MASTER  
FINISH**  
by A.G.Pulie Pty Ltd



**CODE BU01**

This high pressure sprayer is ideal for applying all chemicals including difficult non-dissolvable powders such as Bordeaux.

Made from heavy-duty brass, the BU01 is strong, durable and resists corrosion. The pump uses a cast pressure air chamber and brass ball valves which provide a continuous flow of spray. Adjustable foot rest is also fitted.



## TECH SPECS

- 915mm x 13mm braided plastic hose
- 230mm director
- NZ6 - Adjustable nozzle
- 54mm air chamber

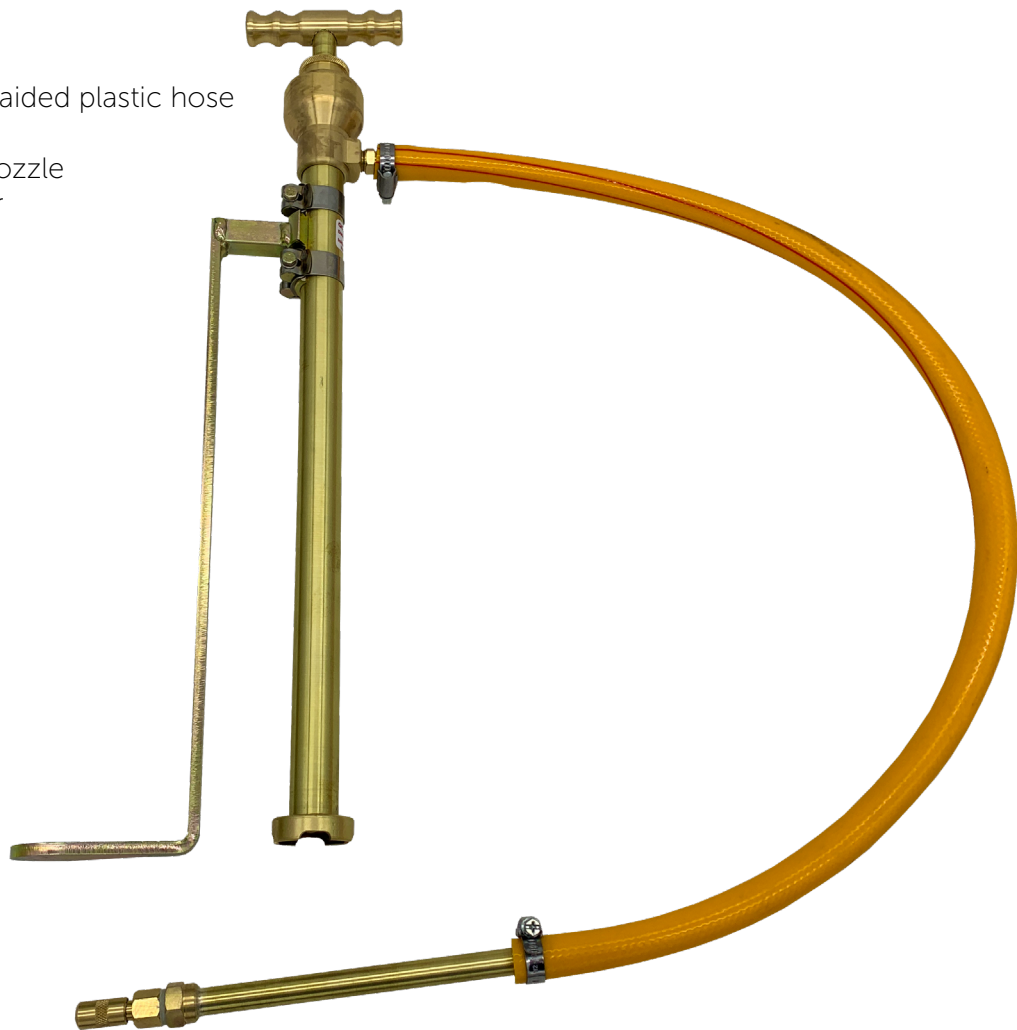



# ROYAL CONDOR 7L HANDY INDUSTRIAL

CODE **HI-003**



RoyalCondor®

The Royal Condor Handy Industrial 7 litre sprayer is a pre-pressure sprayer with Viton seals allowing for use with a broader range of chemicals. Lightweight aluminium lance and a reinforced PVC hose provide durability and long life. 7 litre capacity tank with pressure relief valve.

## TECH SPECS

- 7L tank capacity
- 1m PVC reinforced hose
- 15L/min maximum discharge
- 42cm aluminium lance





# MF INDUSTRIAL CONCRETE SPRAYER



**CODE 308S**

**308S**  
INDUSTRIAL CONCRETE SPRAYER 13.2L 3.5GAL

The Masterfinish 308S Industrial concrete sprayer is of heavy-duty construction and is fully serviceable by design. Backed by the reputation of Masterfinish and AG Pulite since 1951, we offer a range of genuine spare parts that you can depend on.

The 308S sprayer is fully equipped with high-quality VITON seals for long life and superior resistance to solvents and chemicals.

The 308S tank is manufactured from heavy-duty rolled steel and seam welded. Coated inside with high-performance epoxy as a barrier to corrosion and cross-contamination.

### TECH SPECS

- 13.2L/3.5G Capacity tank
- Sprays up to 35% solids
- Hose length – 1.2m/48"
- Flow rate – 0.5g (1.8L) – 1.0g (3.7L)
- Operating pressure – 40-60psi
- 3-Stage locking handle
- Brass Spray handle, Wand and Nozzles



308S



# MF INDUSTRIAL CONCRETE SPRAYER

**MASTER FINISH**  
by A.G. Pulie Pty Ltd

## CODE SPARE PARTS

Master finish 308S seal kits are also supplied as genuine VITON parts.

Component spare parts are all made and machined from high-quality brass for long life and durability.



308HOSE

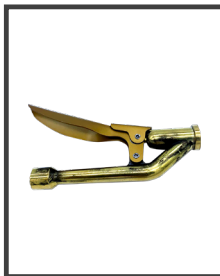

308TRIG



308SEAL



308WAND

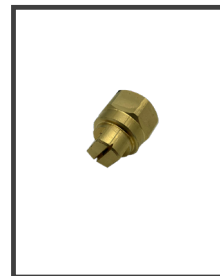

308NZ05

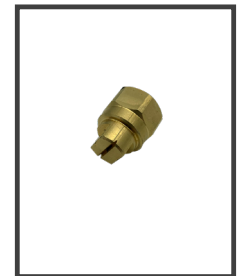

308NZ10

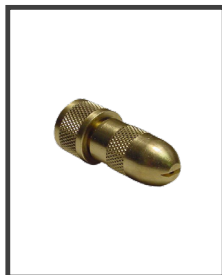

308NZADJ

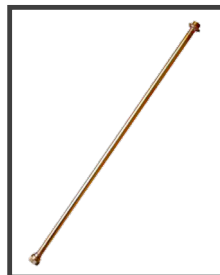

308EXTW

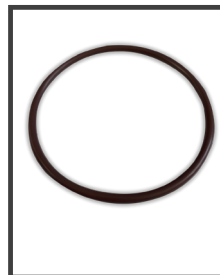

308ORING



308PUMP



308NUT

### 308S Sprayer Available Spare Parts

Code	Description	Barcode
308HOSE	Replacement Hose 48"/1.2m	9318428113686
308TRIG	Replacement Trigger Assy	9318428113693
308SEAL	Seal and Gasket Kit	9318428113709
308WAND	Replacement Wand 24"/600mm	9318428113716
308NZ05	Nozzle 0.5gpm/1.8lpm	9318428113723
308NZ10	Nozzle 1.0gpm/3.7Lpm	9318428113730
308NZADJ	Adjustable Fan Nozzle	9318428113747
308EXTW	Extension Wand 24"/600mm	9318428113761
308PUMP	Complete Pump	9318428113754
308ORING	Top tank O'Ring	9318428113778
308NUT	Replacement Epoxy Nut	9318428113785







# ROYAL CONDOR BACKPACK SPRAYER

**CODE EX-0041**



RoyalCondor®

The Royal Condor EX-0041 is a premium quality backpack sprayer designed for spraying a wide range of products including; retarding agents, curing compounds and form oils. The high pressure developed by the EX-0041 is what sets this sprayer apart from others. The Royal Condor can spray material up to 6m, making it ideal for spraying on large pours.

#### TECH SPECS

- 20L Capacity tank
- 203psi pressure
- Hose length – 1m
- Operating pressure – 150-180psi
- Stainless steel lance





# ROYAL CONDOR BACKPACK SPRAYER

## CODE SPARE PARTS



RoyalCondor®

Spare part components for the Royal Condor EX-0041



### Royal Condor Available Spare Parts

Code	Description	Barcode
RC-305X	Replacement Hose 1.2m	9318428115529
RC-920ENX	Replacement Trigger Assy	9318428115536
RC-830EX	Nozzle Holder	9318428115543
RC-346EX-INX	Replacement Wand - Stainless Steel	9318428115550
RC-350A101X	Nozzle 600cc	9318428115567
RC-400EX	Complete Piston	9318428115574
RC-203X	Container Gasket	9318428115581
RC-103BX	Balls x 2	9318428115505
RC-K8X	Piston Kit	9318428115598
RC-933NX	Trigger Valve filter	9318428115604
RC-410EX	Piston Lid	9318428115611
BQL-4C-1200E	4 Cones Plastic Nozzle	9318428115499
RC-122EX	Pump Racor	9318428115628
RC-124X	Pump Racor O-Ring	9318428115635
RC-301X	Wand O-Ring	9318428115642
RC-352X	Nozzle O-Ring	9318428115659
RC-413X	Piston O-Ring	9318428115666
RC-922NX	Trigger Valve Lid	9318428115673
RC-923ENX	Trigger Valve Plastic Offside	9318428115680
RC-K0X	Repair Kit	9318428115697
RC-K6NX	Trigger Valve Kit	9318428115703
RM-K812PLSX	Pin U Kit	9318428115710



**A.G PULIE**

**BRICK TOOLS**

**SECTION 2**







# BRICK TOOLS



Masterfinish range of brick tools. Profile clamps, both internal and external. Brick Ironers, spoon jointers and Z Jointers. Dori blocks, poly rakers and cavity cleaners. **The complete range of tools any brickie would need.**

## INTERNAL CLAMPS

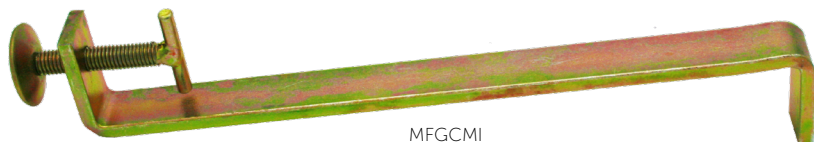

MFGCMI

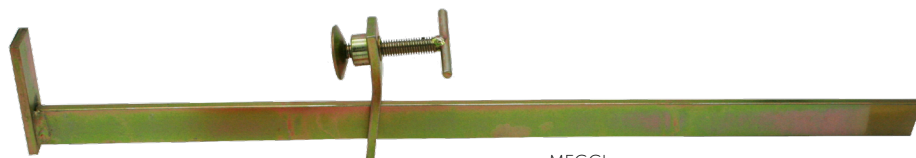

MFGCL

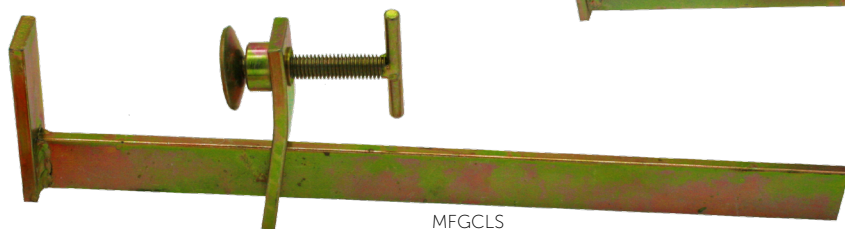

MFGCLS

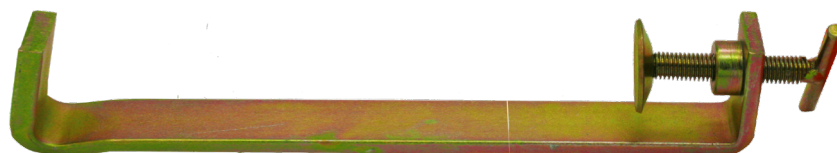

MFGCM

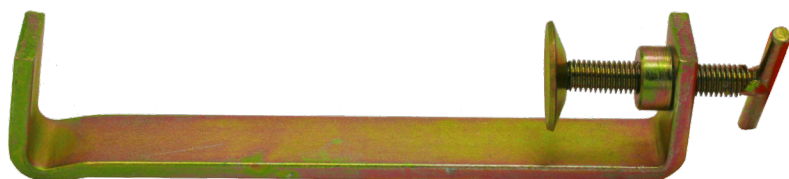

MFGCS



MFGCN

Brick Tools			
Code	Description	Length	Barcode
MFGCL	Large G Clamp	560mm	9318428111804
MFGCLS	Small Sliding G Clamp	335mm	9318428111811
MFGCMI	Medium Internal Clamp	390mm	9318428111835
MFGCM	Medium External clamp	380mm	9318428111828
MFGCN	Nail on G Clamp	360mm	9318428111842
MFGCS	Small External Clamp	270mm	9318428111859



# BRICK TOOLS

**MASTER  
FINISH**  
by A.G.Pulie Pty Ltd

## TOP PROFILE STEADY



MFTOPN

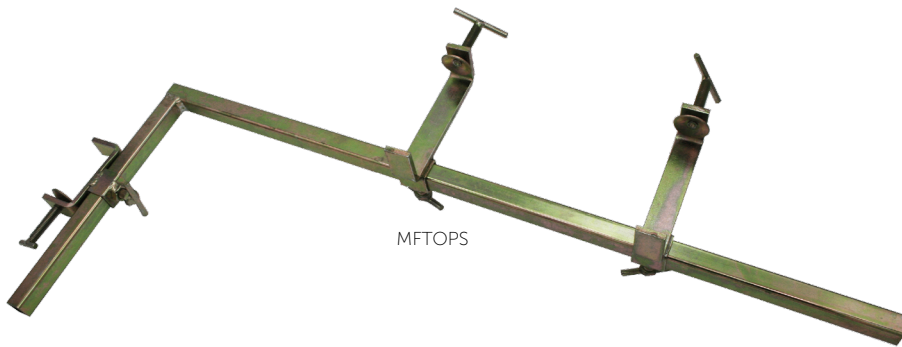

MFTOPS

## CAVITY CLEANER

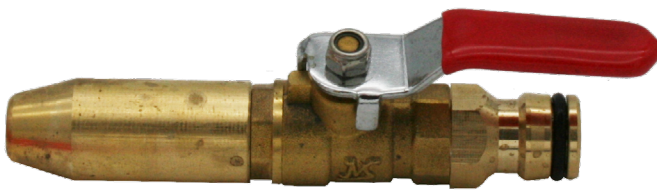

MFCC



MFSPI

## DOOR GAUGE & BLOCK

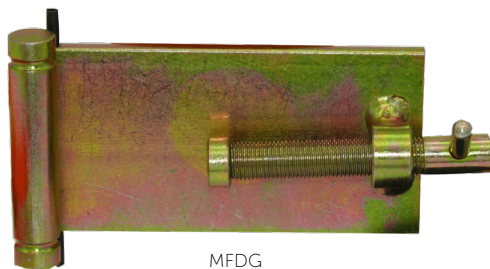

MFDG

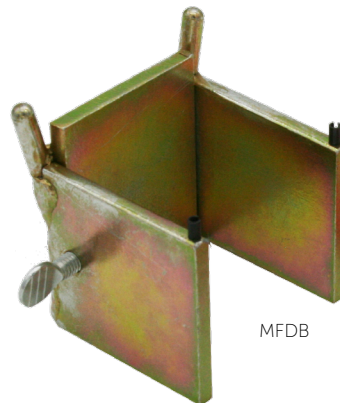

MFDB

Brick tools		
Code	Description	Barcode
MFTOPS	Top Profile Steady	9318428111965
MFTOPN	Uses Nail on Clamps	9318428113327
MFTOPN-HD	Heavy-Duty Top Profile Steady	9318428115994
MFCC	Cavity Cleaner	9318428111750
MFSPI	Internal Spike	9318428111958
MFDG	Door Gauge	9318428111781
MFDB	Dori Block	9318428111767



# BRICK TOOLS



Masterfinish range of brick tools. Profile clamps, both internal and external. Brick Ironers, spoon jointers and Z jointers. Dori blocks, poly rakers and cavity cleaners. Made from high quality steel with a zinc plated finish.

## Z-IRONERS



MFZI16



MFZI12

## SPOON JOINTER

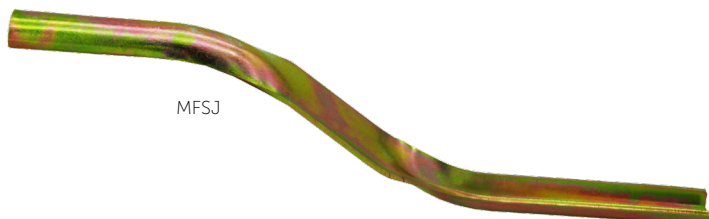

MFSJ

## BARREL JOINTER



MFBJ

## RAKERS

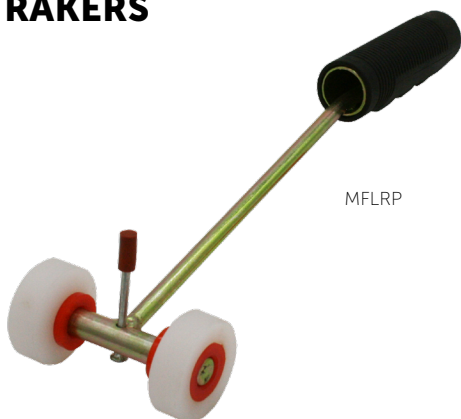

MFLRP



MFRP

Brick tools			
Code	Description	Length	Barcode
MFZI12	Z Ironer 12mm	250mm	9318428111903
MFZI16	Z Ironer 16mm	250mm	9318428111910
MFSJ	Spoon Jointer 10mm/13mm	250mm	9318428111941
MFBJ	Barrel Jointer - 4pc	216mm	9318428115857
MFRP	Poly raker	230mm	9318428111927
MFLRP	Large Poly Raker	300mm	9318428111934

## Heavy-Duty Trestles

Masterfinish heavy-duty trestles are made from tubular powder-coated steel and are certified to Australian standards as per AS/NZS 156.5:1995 Scaffolding - Prefabricated split heads and trestles.

Heavy-Duty Trestles					
Code	Description	Height	Width	Collapsible	Barcode
BT700	Easymix Brick Trestles	700mm	960mm	Yes	9318428124200
BT950	Easymix Brick Trestles	950mm	960mm	Yes	9318428102437



BT700





# BRICK TOOLS

**MASTER  
FINISH**  
by A.G.Pulie Pty Ltd

Masterfinish range of brick tools. Profile clamps, both internal and external. Brick Ironers, spoon jointers and Z jointers. Dori blocks, poly rakers and cavity cleaners. Made from high quality steel with a zinc plated finish.

## BRICK IRONERS

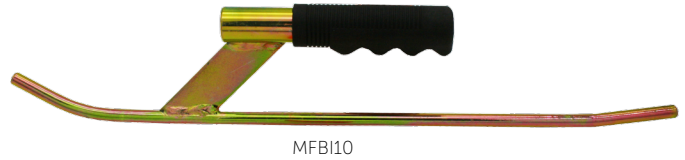

## BRICK CARRIERS

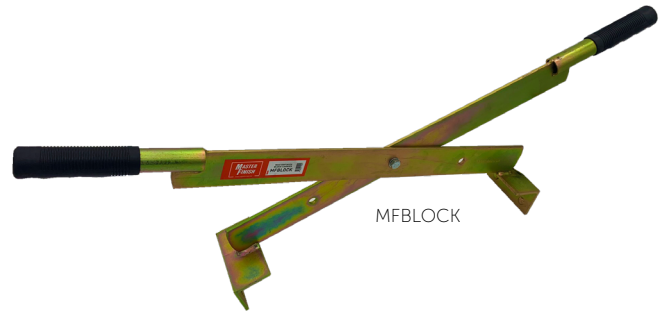
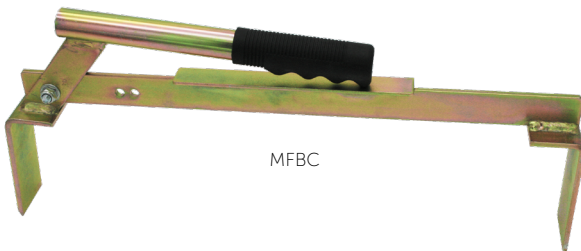

### Brick tools

Code	Description	Barcode
MFBC	Brick Carrier	9318428111330
MFBLOCK	Block Carrier	9318428114294
MFB10	Brick Ironer 10mm	9318428111880
MFB12	Brick Ironer 12mm	9318428111866
MFB16	Brick Ironer 16mm	9318428111897
MFB19	Brick Ironer 19mm	9318428111873



# BRICK TOOLS



## Brickies Brushes

Brickies scrub brush, constructed with a wooden stock and natural Tampico fibres making it perfect for trade use.

Brushes			
Code	Description	Bristles	Barcode
MFBRTL	Tampico Brickies Brush - Large 255mm	40mm	9318428112641
MFBRTS	Tampico Brickies Brush - Small 210mm	40mm	9318428112658
MF-JUB	Jumbo Utility Brush - 166mm	95mm	9318428112351



MFBRTL



MFBRTS



MF-JUB

## Dutch Pins

Made from forged steel with a narrow point that can be hammered into mortar joints to create a fixing point for holding timbers or profile poles

Pins			
Code	Description	Length	Barcode
MFDL-2	Dutch Pins 2pk	150mm	9318428111774
MFDL-50	Dutch Pins 50pk	150mm	9318428112504



MFDL

## Line Pins

Line pins are inserted into a brick course or staked into the ground, and a string line wrapped around and stretched taut between the two points. This can then be used as a reference or guide line. **Made from forged steel**

Pins			
Code	Description	Length	Barcode
MFLP-2	Line Pins 2pk	150mm	9318428111378
MFLP-50	Line Pins 50pk	150mm	9318428111361



MFLP

## Grout Scoop

Made from high density plastic, the Masterfinish grout scoop is designed to efficiently place grout, mortar or any other high density material 50% faster than conventional methods.

Grout Scoop			
Code	Description	Capacity	Barcode
MF-GROUT	Grout Scoop	22kg	9318428115833

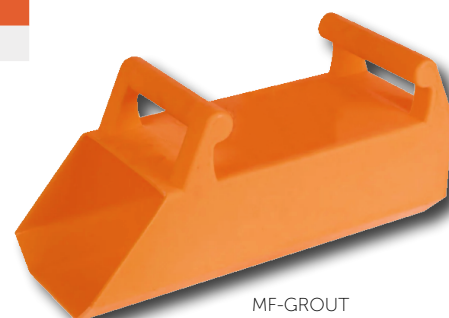

MF-GROUT



# BRICK TOOLS

**MASTER FINISH**  
by A.G.Pulie Pty Ltd

## Rubber Buckets

Ideal for large jobs around the home, garden or construction site. Heavy duty rubber buckets are a versatile bucket with plenty of potential uses. Measuring marks moulded inside the tubs. Four sizes available.

MADE IN FRANCE

Buckets				
Code	Description	Colour	Capacity	Barcode
MFRB-11	Construction Bucket	Black	11L	9318428115796
MFRB-13	Construction Bucket	Black	13L	9318428115802
MFRB-23	Construction Bucket	Black	23L	9318428115819
MFRB-42	Construction Bucket	Black	42L	9318428115826



MFRB-11



MFRB-13



MFRB-23



MFRB-42

## Brick Tapes

Specialised measuring tapes designed for bricklayers. Masterfinish brick tapes include standard metric measurements plus brick gauge measurements of 84, 85, 86 and 87mm. Also includes 230, Maxi and florentine markings



Brick Tapes			
Code	Description	Length	Barcode
MFBT1	The Brick Tape - 32mm	8m	9318428112412
MFBT2	The Bricky Tape - 25mm	8m	9318428112214



MFBT1



MFBT2





# BRICK TOOLS



## Brick Profile Poles

Profile pole used to gauge and mark brick courses prior to bricklaying. 85.7mm spacings, 33 courses. Made from galvanised steel.

Brick Profile Poles					
Code	Description	Length	Courses	Spacing	Barcode
MFPP	Brick Profile Pole	2.8m	33	85.7mm	9318428104745



## Brick Profile Steady

The Masterfinish profile steady is designed to keep the profile pole steady during construction. Made from galvanised steel with an angle base support. Adjustable clamp gives telescopic height adjustment.

Brick Profile Steady			
Code	Description	Length	Barcode
MFPS	Brick Profile Steady	1.8m - 2.5m	9318428104752



## Brickies Gauge Rod

Lightweight aluminium gauge rods designed to measure brick spacing during brick construction work. Engraved at each gauge. Available in gauges 84mm-87mm and 85mm-88mm

Gauge Rods			
Code	Description	Gauge	Barcode
MFBG-8487	Brick Gauge Rod	84-87mm	9318428112429
MFBG-8588	Brick Gauge Rod	85-88mm	9318428112436





# BRICK TOOLS

**MASTER FINISH**  
by A.G.Pulie Pty Ltd

## Builders Line

Masterfinish heavy-duty builders line. Available in lengths of 50, 100 and 500m. Supplied in box quantities of 12pcs

Builders Line			
Code	Description	Length	Barcode
MFBL50-L	Builders Line - 50m Lime Green	50m	9318428114430
MFBL50-P	Builders Line - 50m Pink	50m	9318428114423
MFBL50-W	Builders Line - 50m White	50m	9318428114447
MFBL100-L	Builders Line - 100m Lime Green	100m	9318428114461
MFBL100-P	Builders Line - 100m Pink	100m	9318428114454
MFBL100-O	Builders Line - 100m Orange	100m	9318428114478
MFBL500-L	Builders Line - 500m Lime Green	500m	9318428114485

MFBL100-P



MFBL500-L



## Line Blocks

Masterfinish line blocks. Available in display box quantities of 24pcs - Large & 40pcs - Small

Line Blocks			
Code	Description	Display Box	Barcode
MFLLB-24	Large line blocks - 24pk	Yes	9318428114225
MFSLB-40	Small line blocks - 40pk	Yes	9318428114232

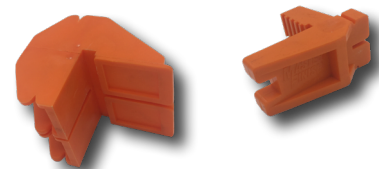

## Plastic Render Scoop

Ideal for scooping render, texture and plaster on to a plaster hawk. Features an ergonomic cushioned handle, strong one-piece construction and bucket hang hook. Available in display box quantities of 10pcs

Render Scoop			
Code	Description	Display Box	Barcode
MF-SCOOP	Plastic render scoop	Yes - 10pc buy	9318428114867





**A.G PULIE**

# **MATERIAL HANDLING**

## **SECTION 3**





PARKVIEW

**DANGER**

DEEP  
EXCAVATION  
KEEP CLEAR



## Easymix

### 80 litre Handyman Wheelbarrow

Wheelbarrows				
Code	Description	Weight	Capacity	Barcode
W200S	80 Ltr Handyman Wheelbarrow	15kg	80L	9318428102703

- 80l seamless tray 1mm powder-coated
- Front Brace & Upright Supports: 25mm tubular uprights
- Nose Guard: 2mm nose guard
- Wheel & Tyre: 16 x 4.8 x 8 Hammer tone steel rim 25mm axle
- Undercarriage: 25mm tubular Bolt together 3 piece



### Blue Steel Handyman Wheelbarrow

Wheelbarrows				
Code	Description	Weight	Capacity	Barcode
W250S	Handyman 100 LT Stl Tray Barrow	16kgs	100ltr	9318428101782

- 100ltr capacity steel tray
- Zinc-coated steel handles 25x50mm
- Powder-coated 30mm flat bar undercarriage
- 25mm upright supports
- 16" x 4-8 pneumatic 4 ply tyre
- Steel rim and 25mm axle



### Poly Handyman Wheelbarrow

Wheelbarrows				
Code	Description	Weight	Capacity	Barcode
W250P	Handyman 100 LT Poly Tray Barrow	13kgs	100ltr	9318428101775

- 100ltr capacity poly tray
- Zinc-coated steel handles 25x50mm
- Powder-coated 30mm flat bar undercarriage
- 25mm upright supports
- 16" x 4-8 pneumatic 4 ply tyre
- Steel rim and 25mm axle







## Red Steel Contractors Wheelbarrow

*Easymix*

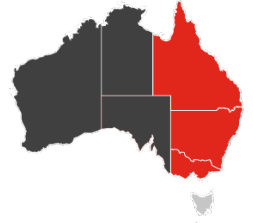

*QLD-NSW-VIC Only*

Wheelbarrows				
Code	Description	Weight	Capacity	Barcode
W300S-HSRWRS	Red W/Barrow with Steel Tray	23kg	100ltr	9318428100280

- 100ltr capacity red steel tray
- Seamless 0.9mm powder-coated tray
- Powder-coated steel handles 25x50mm
- Powder-coated 32mm K-frame undercarriage
- 32mm upright supports
- 16"x6.50-8 pneumatic 4 ply tyre
- Steel rim and 25mm axle
- 32mm cross tray support bars



## Red Poly Contractors Wheelbarrow

*Easymix*

Wheelbarrows				
Code	Description	Weight	Capacity	Barcode
W300P-HSRWRS	Red W/Barrow with Poly Tray	20kg	100ltr	9318428100198

- 100ltr poly tray
- Powder-coated steel handles 25x50mm
- Powder-coated 32mm K-frame undercarriage
- 32mm upright supports
- 16" x 6.50-8 pneumatic 4 ply tyre
- Steel rim and 25mm axle
- 32mm cross tray support bars







### Green Steel Heavy Duty Contractors Wheelbarrow

Wheelbarrows				
Code	Description	Weight	Capacity	Barcode
W800S-HSGWAS	Green Steel Contractors Wheelbarrow	25kg	100ltr	9318428100686

- High capacity seamless 100ltr 1.2mm steel tray
- 1.0mm steel tray
- 7mm poly impact board
- Powder-coated steel handles 57 x 35mm
- Contoured handle grips
- Heavy-duty 32mm tubular welded legs
- 16 x 6.5 x 8 pneumatic tyre



### Green Poly Heavy Duty Contractors Wheelbarrow

Wheelbarrows				
Code	Description	Weight	Capacity	Barcode
W800P-HSGWAS	Green Poly Contractors Wheelbarrow	21kg	100ltr	9318428100778

- High capacity 100ltr Poly Tray
- Built-in pouring lip
- 7mm poly impact board
- Powder-coated steel handles 57 x 35mm
- Contoured handle grips
- Heavy-duty 32mm tubular welded legs
- 16 x 6.5 x 8 pneumatic tyre
- 25mm axle and steel rim





*Easymix*

## Blue Steel Super Heavy-Duty Contractors Wheelbarrow

### Wheelbarrows

Code	Description	Weight	Capacity	Barcode
W900S-HSBWAS	Blue Steel W/Barrow HD Steel Tray	28.5kg	100ltr	9318428103106

- High capacity seamless 100ltr 1.2mm tray
- 7mm Poly impact board
- Powder-coated steel handles 57 x 35mm
- Contoured handle grips
- Heavy-duty 32mm tubular welded legs
- 25mm cross tray support
- 16 x 6.5 x 8 pneumatic tyre
- Heavy-duty steel rim and solid 25mm axle



## Super Heavy-Duty Contractors Wheelbarrow with Pouring Lip

*Easymix*

### Wheelbarrows

Code	Description	Weight	Capacity	Barcode
W900P-HSBWAS	Blue W/Barrow HD Poly Tray	20kg	100ltr	9318428102994

- High Capacity rotational moulded 5mm poly tray, 100L
- Built-in pouring lip
- Powder-coated steel handles 57 x 35mm
- Contoured handle grips
- Heavy-duty 32mm tubular welded legs
- 25mm cross tray support
- 16 x 6.5 x 8 pneumatic tyre
- Heavy-duty steel rim and solid 25mm axle





## Super Heavy-Duty Contractors Wheelbarrow

*Easymix*

Wheelbarrows				
Code	Description	Weight	Capacity	Barcode
W1000-HBHNGS	Boss Timber Handle Pneumatic Barrow	32kg	100ltr	9318428100273

- 100ltr 1.2mm folded heavy-duty tray
- Timber handles 32 x 55 x 1500mm
- 1.2mm steel impact board
- Heavy-duty 32 x 6mm flat bar undercarriage
- 32mm pipe under tray supports
- 16 x 4.00-8 pneumatic 6 ply tyre
- Heavy-duty steel rim and 25mm solid axle



## Super Heavy-Duty Square Tray Contractors Wheelbarrow

*Easymix*

Wheelbarrows				
Code	Description	Weight	Capacity	Barcode
FU1200-HBHNGS	Fugly Timber Handle Pneumatic Square Barrow	32kg	100ltr	9318428101959

- 100ltr 1.2mm folded heavy-duty Square tray
- Timber handles 32 x 55 x 1500mm
- 1.2mm steel impact board
- Heavy-duty 32 x 6mm flat bar undercarriage
- 32mm pipe under tray supports
- 16 x 4.00-8 pneumatic 6 ply tyre
- Heavy-duty steel rim and 25mm solid axle







## Heavy-Duty Contractors Wheelbarrow

*Easymix*

Wheelbarrows				
Code	Description	Weight	Capacity	Barcode
W566S	Heavy-Duty Red Steel Tray W/barrow	23kg	99ltr	9318428100525

- High capacity 99ltr 1.0mm powder-coated steel tray
- Powder-coated steel handles 25 x 50mm
- Contoured handle grips
- Heavy-duty 32mm tubular welded legs
- 16 x 6.5 - 8 Pneumatic 4 ply tyre
- Heavy duty steel rim and solid 25mm axle
- Fitted with a large lifting hook



## Heavy-Duty Contractors Wheelbarrow

*Easymix*

Wheelbarrows				
Code	Description	Weight	Capacity	Barcode
W566P	Heavy-Duty Red Poly Tray W/barrow	20kg	99ltr	9318428102161

- High capacity 99ltr 1.0mm poly tray
- Powder-coated steel handles 25 x 50mm
- Contoured handle grips
- Heavy-duty 32mm tubular welded legs
- 16 x 6.5 - 8 Pneumatic 4-ply tyre
- Heavy-duty steel rim and solid 25mm axle
- Fitted with a large lifting hook





## Heavy-Duty Contractors Wheelbarrow with Pouring Lip

*Easymix*

Wheelbarrows				
Code	Description	Weight	Capacity	Barcode
W500P	Heavy Duty Narrow Pouring W/Barrow	18kg	65ltr	9318428101553

- High capacity 65ltr poly tray
- Built-in pouring lip
- Narrow design, 560mm wide
- Perfect for doorways
- Powder-coated steel handles 32mm
- Contoured handle grips
- Heavy duty 32mm tubular welded legs
- 16 x 4.00 - 8 pneumatic 6 ply tyre
- Heavy-duty steel rim and solid 25mm axle

*Fits through doorways easily*



## Mulch Mover Wheelbarrow

*Easymix*

Wheelbarrows				
Code	Description	Weight	Capacity	Barcode
W830P-HSGWAS	Mulch Mover Wheelbarrow	22kg	130ltr	9318428111347

- 130L Capacity Poly Tray
- Powdercoated Steel Handles
- Heavy Duty Tubular Steel legs
- Contoured handle grips





*Easymix*

## Boss Brickies Flat Tray Wheelbarrow

Wheelbarrows			
Code	Description	Weight	Barcode
W1100-HBHNGS	Boss Brickies Flat Tray Timber Handle	27kg	9318428101560

- 1.2mm galvanised folded steel
- Timber handles 32 x 55 x 1500mm
- 1.2mm galvanised impact board
- Heavy-duty 32 x 6mm flat bar undercarriage
- 32mm pipe under tray supports
- 16 x 4.00-8 pneumatic 6-ply tyre
- Heavy-duty steel rim and solid 25mm axle



## Brick Trolleys

*Easymix*

Brick Trolleys		
Code	Description	Barcode
BT-1	Brick Trolley Straight Handles	9318428101430
BT-2	Brick Trolley Curled Handles	9318428101447

- Heavy gauge pipe frame
- 16.650x8 heavy duty steel rim
- 4-ply tyres







### P-Handle Trolleys

Trolleys				
Code	Description	Weight Capacity	Wheel Type	Barcode
PT700FF	Easymix P Handle Trolley	200kg	Flat Free	9318428107005

- 350 x 215 x 3mm shoe
- Dimensions: 1320 (h) x 555mm (w)
- Construction for light use and fully powder-coated
- Fully-welded frame gives maximum strength and longevity
- Ergonomically designed "P" handle to help better control for single-handed use
- Replacement Wheel: PT-FF

**200KG**  
Wheel Type  
Flat Free



### General Purpose Trolley

Trolleys				
Code	Description	Weight Capacity	Wheel Type	Barcode
HT700HD	Easymix General Purpose Hand Trolley	200kg	Flat Free	9318428100242

- 230 x 335 x 9mm shoe
- Dimensions: 1200 (h) x 540mm (w)
- Constructed for light use and fully powdercoated
- Fully-welded frame gives maximum strength and longevity
- 250 x 70mm poly-rimmed puncture proof wheels for increased productivity
- Replacement wheel: HT-HD

**200KG**  
Wheel Type  
Flat Free



### Multi Adjustable Trolley

Trolleys				
Code	Description	Weight Capacity	Wheel Type	Barcode
MT700	Easymix Multi Purpose Adjustable Hand Trolley	200kg	Flat Free	9318428101874

- 240x330x3mm shoe
- Dimensions: 1230- 1500 (h) x 500mm (w)
- Robust construction for extra strength and fully powder-coated
- Fully-welded steel frame gives maximum strength and longevity
- 2 caster wheels for multi directional movement
- 250x70mm poly rimmed puncture proof wheels
- Replacement wheel: PT-FF

**200KG**  
Wheel Type  
Flat Free





# SPARE WHEELS



## Wheelbarrow Spare Wheels



NSP005  
Narrow Pneumatic



WSP001  
Wide Pneumatic



NGS  
Heavy Duty  
Narrow Pneumatic



NSF006  
Narrow Flat Free



WSF002  
Wide Flat Free



WGP  
Wide Steel Flat Free  
Grey



NBS  
Narrow Steel Flat Free  
Grey

### Wheelbarrow Spare Wheels

Code	Description	Dimensions	Rim	Colour	Bore Size	Barcode
NGS	Heavy-Duty Narrow Pneumatic Tyre	4.00-8	Steel	Grey	25mm	9318428100648
WSP001	Wide Pneumatic Tyre	16x6.50-8	Steel	Red	25mm	9318428100822
NBS	Narrow Flat Free Tyre	4.00-8	Steel	Grey	25mm	9318428100631
WSF002	Wide Flat Free Tyre	16x6.50-8	Steel	Red	25mm	9318428100839
NSP005	Narrow Pneumatic Tyre	4.00-8	Steel	Red	25mm	9318428100860
NSF006	Narrow Flat Free Tyre	4.00-8	Steel	Red	25mm	9318428100877
WGP	Wide Flat Free Tyre	16x6.50-8	Steel	Grey	25mm	9318428100624

## Trolley Spare Wheels



PT-PN



PT-FF



HT-HD

### Trolley Spare Wheels

Code	Description	Diameter	Tyre Width	Rim	Bore Size	Barcode
PT-PN	Pneumatic Tyre	260mm	75mm	2 Piece Steel	16mm	9318428105162
PT-FF	Flat Free Tyre	250mm	60mm	Steel	16mm	9318428102963
HT-HD	Flat Free Tyre	250mm	60mm	Steel	16mm	9318428102796





**A.G PULIE**

**MACHINERY**

**SECTION 4**



*M.G. Pullie*  
1951





# DRIVE UNITS



The Masterfinish Drive Unit will drive most makes of flexible vibration shafts and pumps.

**Made with a heavy-duty steel frame & spring or rubber vibrating motor mounts for extra durability.** Heavy-duty 3-tooth drive dog and housing makes for a quick action connection.

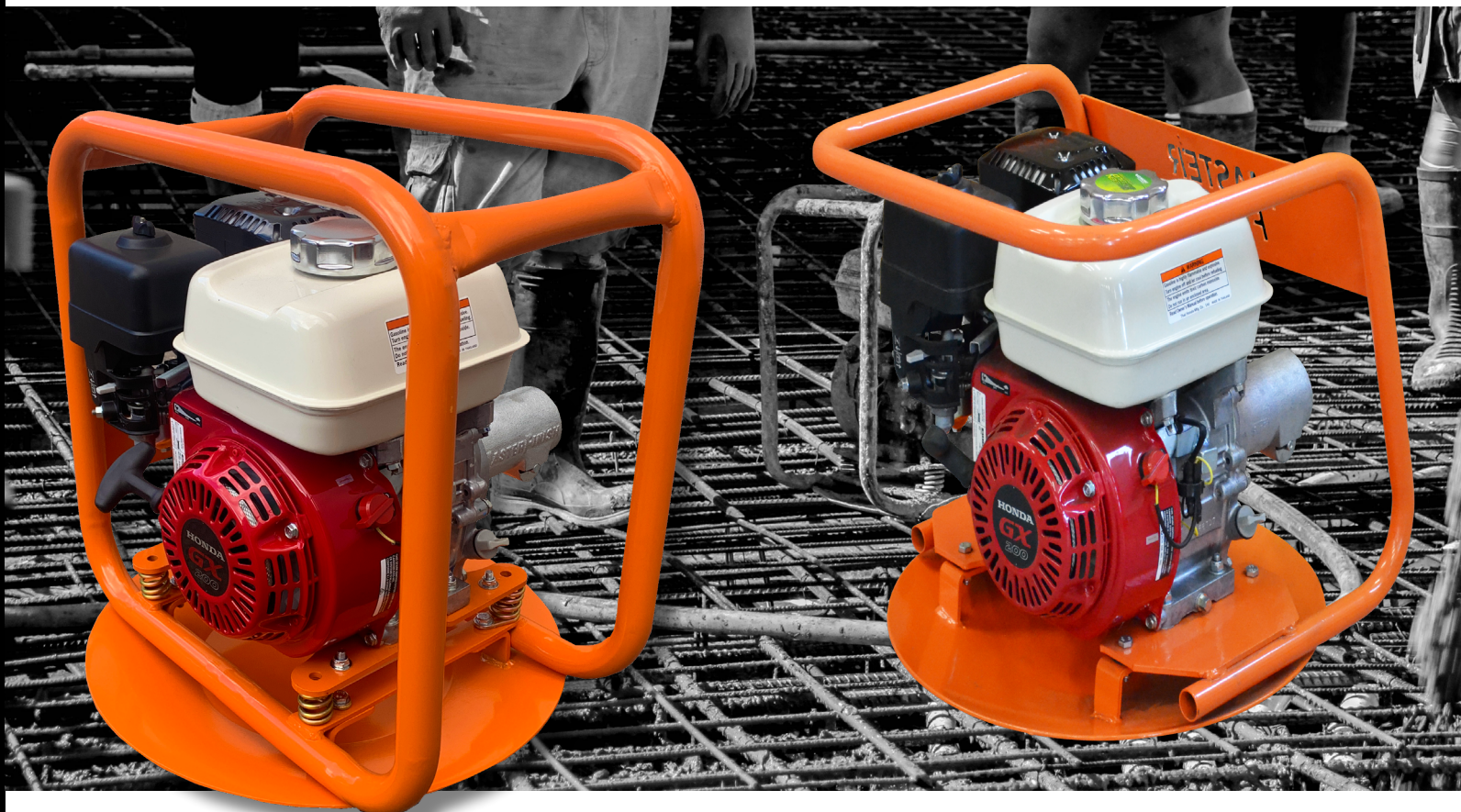

**CODE K1620**

**POWERED by HONDA**



**CODE K1610**

**12-month machine warranty | 36 month Honda warranty for Australia only | Available w/ Yanmar Diesel fitted. K1620 Only**

### Drive Units

Code	Description	Weight(kg)	Engine	Motor Mounts	Drive Dog
K1620	Spring mounted Honda Drive Unit	30	Honda GX200	Spring	3/4" Tooth
K1610	Solid mounted Honda Drive Unit	25	Honda GX200	Solid	3/4" Tooth

### Technical Specs

Code	Power (KW)	Horse power	Capacity (cc)	Motor Speed (RPM)	Oil Level (ml)	Frame type	Fuel
K1620	4.1	5.5	200	3000	600	Full Frame	4-Stroke
K1610	4.1	5.5	200	3000	600	C-Frame	4-Stroke





# DRIVE UNITS

**MASTER  
FINISH**  
by A.G.Pulie Pty Ltd

The Masterfinish Drive Unit will drive most makes of flexible vibration shafts and pumps.  
**Made with a heavy-duty steel frame & spring or rubber vibrating motor mounts for extra durability.** Heavy-duty 3-tooth drive dog and housing makes for a quick action connection.



Electric Start



**CODE YK1620**

**CODE YK1620-ES**

**12-month machine warranty** | Available w/ Yanmar Diesel fitted.

Drive Units					
Code	Description	Weight(kg)	Engine	Motor Mounts	Drive Dog
YK1620	Yanmar Drive Unit	41	Yanmar L48N-MTMR	Spring	3/4" Tooth
YK1620-ES	Electric Start Diesel Drive Unit	42	Yanmar L48N-MTMRYS	Rubber	3/4" Tooth

Technical Specs							
Code	Power (KW)	Horse power	Capacity (cc)	Motor Speed (RPM)	Oil Level (ml)	Frame type	Fuel
YK1620	3.5	4.7	211	3600	800	Full Frame	Diesel
YK1620-ES	3.5	4.7	211	3600	800	Full Frame	Diesel





# VIBRATING SHAFTS



## CODE MFVS

**Flexible vibration shafts provide high frequency vibration from a low flex shaft speed.**

The pendulum tip vibrator generates a high frequency vibration that drives out entrapped air to provide improved compaction, strength and finish of concrete. Made to endure the tough conditions of the work-site, the design and materials used in their manufacture ensures a high quality product.

They can effectively compact up to 25m<sup>3</sup>/H of concrete.

The flexible shaft is internally reinforced and strengthened with an integrated metallic mesh.

Available with steel tip and also resilient tip.

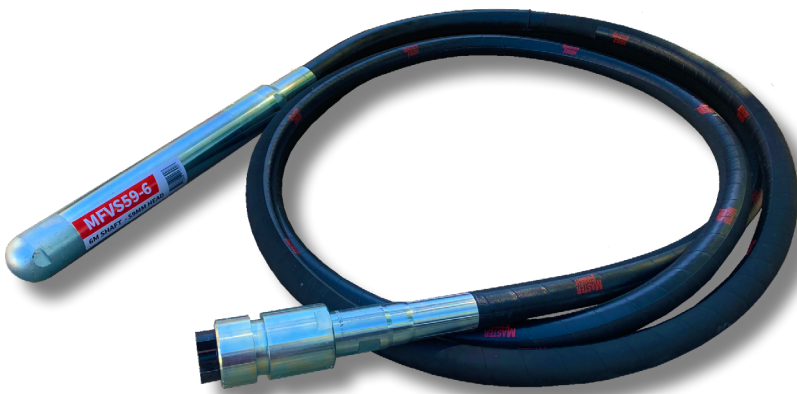

MFVS59-6



MFVS45-6R

**WARRANTY** 6 months

Code	Diameter	Shaft length	Tip	Weight (kg)	Vpm	Performance	Barcode
MFVS28-6	28mm	6m	Steel	17	16000	5m <sup>3</sup> /H	9318428113501
MFVS38-6	38mm	6m	Steel	18	12000	12m <sup>3</sup> /H	9318428113884
MFVS45-6	45mm	6m	Steel	20	12000	17m <sup>3</sup> /H	9318428113891
MFVS59-6	59mm	6m	Steel	22	12000	22m <sup>3</sup> /H	9318428113907
MFVS38-9	38mm	9m	Steel	24	12000	12m <sup>3</sup> /H	9318428113532
MFVS45-9	45mm	9m	Steel	28	12000	17m <sup>3</sup> /H	9318428113525
MFVS59-9	59mm	9m	Steel	32	12000	22m <sup>3</sup> /H	9318428113518
MFVS38-6R	38mm	6m	Resilient	18	12000	12m <sup>3</sup> /H	9318428113594
MFVS45-6R	45mm	6m	Resilient	20	12000	17m <sup>3</sup> /H	9318428113891
MFVS59-6R	59mm	6m	Resilient	22	12000	22m <sup>3</sup> /H	9318428113570
MFVS38-9R	38mm	9m	Resilient	24	12000	12m <sup>3</sup> /H	9318428113549
MFVS45-9R	45mm	9m	Resilient	28	12000	17m <sup>3</sup> /H	9318428113556
MFVS59-9R	59mm	9m	Resilient	32	12000	22m <sup>3</sup> /H	9318428113563



# CEMTOOL SHAFTS

**CODE CTVS**



**Features:**

- Australian standard 3 Dog Drive
- **Metal spiral protection on poker and drive ends**
- Full range of popular sizes
- **Quick change coupling**
- Hardened steel head
- **Heavy duty casing and inner core**
- Low drive unit and vibrator speed extends life of shaft
- **Fits all Australian standard 3 dog drive units**



**WARRANTY** 3 months

Code	Diameter	Shaft length	Head length	Weight	Vpm	Performance	Barcode
CTVS38-6	38mm	6m	470mm	18kg	1200	12m <sup>3</sup> /H	9318428104103
CTVS45-6	45mm	6m	470mm	20kg	1200	17m <sup>3</sup> /H	9318428104110
CTVS59-6	59mm	6m	486mm	22kg	1200	22m <sup>3</sup> /H	9318428104127



# MASTERFINISH POKERVIBE

**MASTER  
FINISH**  
by A.G.Pulie Pty Ltd



**CODE MFPV45B**

POWERED by  
**HONDA**

**3** YEAR  
COMMERCIAL  
ENGINE WARRANTY  
FOR AUSTRALIA ONLY



Display Stands Available

No additional requirements for drive units or shafts. Ergonomic designed handle and shoulder strap.

**Full range of spare parts available**

### Features:

- Professional mini 4 stroke built to be tough, reliable and efficient
- Feature for feature, they offer you the best value for money
- Conveniently located on/off switch
- Shoulder strap
- Adjustable handle
- Rubber reinforced flex shaft
- Hardened Steel head
- Ideal for smaller scale concretors and contractors.
- Genuine Honda GX 35 4 Stroke
- 45mm Vibrating Head – 9000 vpm
- Weight 12 kg

### Specifications:

- Engine Honda GX 35 4-Stroke
- Needle Diameter 45mm
- Fuel Unleaded
- Power 1kw/1.35hp
- Capacity 35cc
- Weight 12 kg

**6-month** machine warranty. **6-month** flex shaft warranty  
**36-month** Honda warranty.

### PokerVibe

Code	Description	Weight	Engine	Nose Type	Diameter	Frequency	Fuel	Power	HP	Capacity	Oil level	Barcode
MFPV45B	Masterfinish Pokervibe	12kg	Honda GX35	Hard	45mm	9000	4-Stroke	1kw	1.3	35.8cc	100ml	931842811125





# MASTERFINISH HANDYVIBE

**MASTER  
FINISH**  
by A.G.Pulie Pty Ltd

**PREMIUM CONCRETE VIBRATOR**

**CODE HV44E**



M/COVER

**Motor Cover**

available for Handyvibe and Pokervibe.

**No additional requirements for drive units or shafts.**

Ergonomic designed handle and shoulder strap. Available as standard, deluxe or resilient nose. Local parts and service.

HV44 Sold with motor protection cage

M/COVER-SMALL Suits HV44E & MFPV45B  
M/COVER-MEDIUM Suits HV44

**12-month** machine warranty. **6-month** flex shaft warranty  
**36-month** Honda warranty.



POWERED by **HONDA**



HandyVibe												
Code	Description	Weight	Engine	Nose Type	Diameter	Frequency	Fuel	Power	HP	Capacity	Oil level	Barcode
HV44E	Cageless Masterfinish HandyVibe	12kg	Honda GX35	Hard	44mm	9000	4-Stroke	1kw	1.3	35.8cc	100ml	9318428651454
HV44	Masterfinish HandyVibe w/ cage	13kg	Honda GX35	Hard	44mm	9000	4-Stroke	1kw	1.3	35.8cc	100ml	9318428651447
HV44ER	Cageless HandyVibe with Resilient tip	12kg	Honda GX35	Polyurethane	44mm	9000	4-Stroke	1kw	1.3	35.8cc	100ml	9318428103564
HV44R	HandyVibe w/cage & Resilient tip	13kg	Honda GX35	Polyurethane	44mm	9000	4-Stroke	1kw	1.3	35.8cc	100ml	9318428651461

Code	Description	Size	Suits	Barcode
M/COVER-SMALL	Motor cover for PokerVibe & HandyVibe	Small	MFPV45B-HV44E-HV44ER	9318428112887
M/COVER-MEDIUM	Motor cover for PokerVibe & HandyVibe	Medium	HV44 - HV44R	9318428112894



# MASTERFINISH POST DRIVER



CODE **MFPD**



POWERED by **HONDA**

**3** YEAR  
COMMERCIAL  
ENGINE WARRANTY  
FOR AUSTRALIA ONLY

- Supplied with the following
- Star picket attachment
  - 58mm reducing tube
  - Post grab attachment

## POST DRIVER

### Masterfinish petrol powered post driver

Lightweight and portable post driver, designed to drive star or Y pickets into the ground in seconds. Powered by the reliable Honda GX35 engine, the post driver produces an amazing 1720 blows per minute. CNC machined body from high strength aluminium, spring loaded handles to reduce user fatigue and quality sealed bearings.

Easy grip rubber handles with ergonomic throttle control.

Code	Description	Weight (Kgs)	Engine	Blows per min	Impact force	Max post size	Barcode
MFPD	Post Driver	15kg	GX35	1720	0.026KN	76mm	9318428115437



# MASTERFINISH PICKET & POST REMOVER

**MASTER  
FINISH**  
by A.G.Pulic Pty Ltd

**POSTJAK**  
POST & PICKET PULLER

**CODE MFPJ-S**



MasterFinish PostJak, picket and post remover. With its dual head design the postjak can be used to remove both star pickets and posts up to 25mm in size. Multi point hardened jaws can be rotated for 4x extra life. Available in small - 500mm and Large - 900mm. Ideal for concrete and construction trades, landscaping and also fencing contractors

**CODE MFPJ-L**

**Telescopic handle features on both sizes for extra leverage. Spare jaws and pins are available.**

Code	Description	Weight (Kgs)	Height	Jaw Opening - Pickets	Jaw Opening - Posts	Barcode
MFPJ-L	PostJak - Large	12.5kg	900mm	15mm	25mm	9318428114843
MFPJ-S	PostJak - Small	10.5kg	500mm	15mm	25mm	9318428114836







# HANDYVIBE VOLT

**MASTER  
FINISH**  
by A.G.Pulvie Pty Ltd

**HandyVIBE**  
**3 YEAR**  
COMMERCIAL  
ENGINE WARRANTY  
FOR AUSTRALIA ONLY

**POWERED by  
HONDA™**

**CODE MFHV44**

## Introducing the all new MasterFinish HandyVibe Volt.

A 40v battery powered portable concrete vibrator.

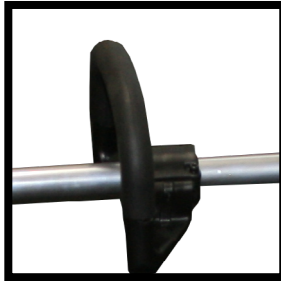
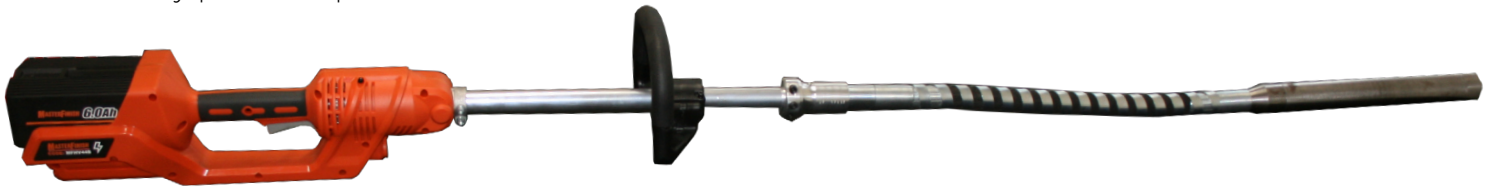

### A 40v battery powered portable concrete vibrator.

Based on our market leading petrol powered Handyvibe, the Volt offers a real alternative for job situations where petrol engines may not be suitable. *eg. Underground works, internal works.*

**MFHV44-C50**  
Replacement  
Charger

**MFHV44-E60**  
Replacement  
Battery

The complete package includes the **HandyVibe-Volt unit**, as well as the **40v battery** and **charger**.

### Features

- Powerful 6.0Ah 40V Battery
- 44mm Vibrating head
- Approx 8000 vibrations per minute @ 6300 rpm
- Ergonomic D Handle
- Approx 40mins Continuous run time
- Extra batteries available
- Uses the same components as the petrol powered model

**12-month** machine warranty  
**6-month** flex shaft warranty  
**6-month** warranty for battery

### Handyvibe Volt

Code	Description	Weight (Kgs)	Head Size	Charge Time	V.P.M	Barcode
MFHV44B	HandyVibe-VOLT	10	44mm	1hr	8000	9318428110852
MFHV44-C50	Replacement Battery Charger					9318428110876
MFHV44-E60	Replacement Battery					9318428110869



# PUMPS



## CODE **KS212**

Masterfinish flexible shaft-driven heavy-duty pumps are portable and can be used in a variety of applications. Available as standard premium heavy-duty pump or heavy-duty cast iron model - both with stainless steel impeller for improved abrasion resistance.

Self-priming, choke resistant spindle and oil bath lubrication.

Fitted with a quick action flexshaft coupling with a 3-tooth drive dog enabling them to be operated by all standard drive units. Fitted with an adaptor for cam-lock quick action hose fittings. Comes fitted with an anti-kink device; you can move the coil on the shaft to where the pump needs to go over an edge etc. to help prevent the flexible shaft from kinking.



KS212

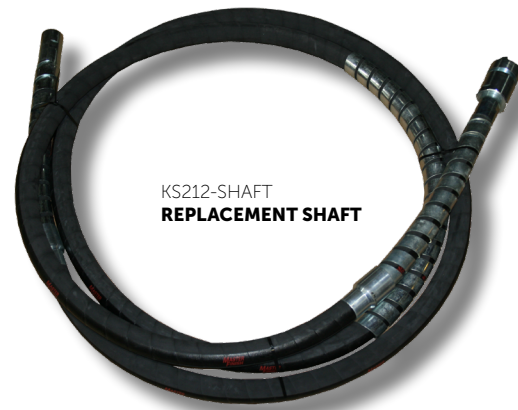

KS212-SHAFT  
REPLACEMENT SHAFT



LFH20  
Lay Flat Hose to Suit

12 month warranty on pump head; 6 month warranty on flexible shaft. Stainless steel impeller as standard.

### Submersible Pumps

Code	Description	Weight (Kgs)	Pump Head	Barcode
KS212	Masterfinish Submersible Pump	32	Aluminium	9318428100433
KS212CI	Masterfinish Submersible Pump	40	Cast Iron	9318428100440
KS212-SHAFT	Replacement shaft for the KS212 & KS212CI Submersible pump	20		9318428110296

### Technical Specs

Code	Impeller	Max Head Height	Discharge Dia (mm)	Max Discharge Capacity (L/hr)	Size of Solids	Shaft Length	Weight
KS212	Stainless Steel	22M @ 3600RPM	50	62000	25	6	32kgs
KS212CI	Stainless Steel	22M @ 3600RPM	50	62000	25	6	40kgs

Lay flat hose, ►  
see next page



# SHAFT EXTENSION

## CODE KSES

Extension shafts that can be used to extend the length of either vibrating shafts or submersible pumps. Suits any shaft using the standard 3 dog drive.



KSES

### Extension Shafts

Code	Description	Length (m)	Weight (kgs)	Barcode
KSES	3m Shaft Extension	3	14	9318428109146
KSES6	6m Shaft Extension	6	22	9318428104080

# HOSE

## CODE LFH20

Extruded nitrile and circular woven Polyester/ Nylon reinforced hose with very low expansion and elongation properties.

All fittings are included.



LFH20

### Lay-Flat Hose

Code	Description	Length (m)	Barcode
LFH20	50mm Lay-Flat delivery hose	20	9318428101676





# CUB GRINDER

**CODE MF-CUB**

The Masterfinish Cub Grinder is easy to control for both wet and dry grinding with a level adjustment on rear wheels for perfectly even surfaces and handling. Water tap connection and vacuum port for dust minimization and extraction. Suits 250mm grinding discs.

**Features a floating head dust shroud to pick up maximum dust plus height control (three positions) to cater for all operator sizes.**

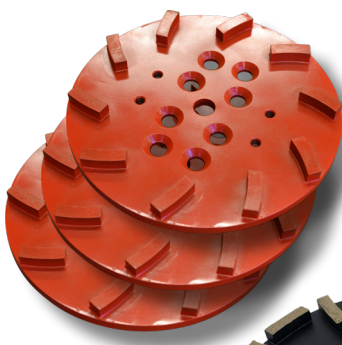

HGH10

**Multiple number of disk segments available.**

*Not included with machine*



HGH20



MF-CUB

**12-month machine warranty**

## Floor Grinders

Code	Description	Weight	Motor Size (KW)	Motor Voltage (V)	Disc Speed (RPM)	Disc Diametre (mm)	Vacuum Port Size	Barcode
MF-CUB	Diamond Disc Floor Grinder	47	2.2	240	1450	250	51	9318428102772
HGH10	10"Grinding Plate 10 SEG	2	N/A	N/A	N/A	10"	N/A	9318428106213
HGH20	10" Grinding Plate 20 SEG	2	N/A	N/A	N/A	10	N/A	9318428104585
BMCG22-01-23	Dust Skirt	N/A	N/A	N/A	N/A	N/A	N/A	9318428115512



# PORTABLE GENERATOR

**CODE MF270**

MasterFinish MF270 inverter generator. Powered by a 79cc 4-Stroke engine, this generator provides 2.1kw running power and 3.0kw of starting power. Recoil starting mechanism and a 4L capacity fuel tank.

**Features 2 x power sockets and dual USB sockets. Overload alarm, low oil alarm, fuel gauge and ECO mode.**



### PortaPower Inverter Generator

Code	Description	Weight	Motor Size	Motor Voltage	Run Power	Start Power	Sockets	Fuel Capacity	Barcode
MF270	Masterfinish Generator	19	79cc	240	2.1kw	3.0kw	2	4L	9318428115123



# PRESSURE WASHER



**CODE MFPW3000**

POWERED by **HONDA**™



## Masterfinish 3000psi pressure washer

Using a high-flow gear driven pump the MFPW3000 provides a maximum 3000psi of pressure with a flow rate of 11.9LPM. Powered by a Honda GX200 engine, the gear driven pump is a more reliable and stable platform than other direct drive pressure washers.

Heavy-Duty gun and lance with turbo nozzle, 10m hose length.  
Hot dipped galvanised frame.



**Supplied with stainless steel lance & turbo nozzle as well as a separate lance with 15 degree nozzle**

GUN3000



HOSE3000-10



TURBON3000



LANCE3000

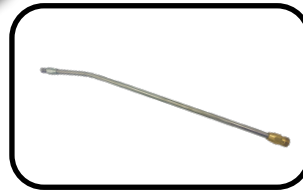

LANTURBO3000

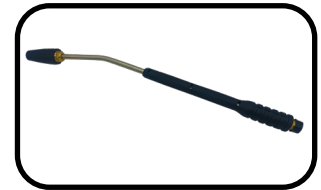

### Pressure Washer

Code	Description	Weight	Engine	Max Pressure	Max Flow	Hose length	Pump	Barcode
MFPW3000	Masterfinish Pressure Washer	25kg	Honda GX200	3000psi	11.9lpm	10m	Gear driven	9318428115109

### Spare Parts

Description	Barcode
LANTURBO3000 Lance with Turbo nozzle	9318428115215
LANCE3000 Lance with 15 deg nozzle	9318428115208
TURBON3000 Replacement Turbo nozzle	9318428115246
GUN3000 Replacement Gun	9318428115222
HOSE3000-10 Replacement 10m Hose	9318428115253





# PRESSURE WASHER



## CODE MFPW3000-HD

POWERED by HONDA™



### Masterfinish 3000psi pressure washer

Heavy-Duty tubular steel frame with hot-dipped galvanised finish. Genuine Honda GX200 engine mounted on rubber anti-vibration mounts, the MFPW3000-HD is a contractor level pressure washer. High-flow, gear driven pump with brass inlet filter, thermal overload and brass hose connection. Stainless steel, heavy-duty lance with turbo nozzle, 10m non-marking hose.



**Supplied with stainless steel lance & turbo nozzle as well as a separate lance with 15 degree nozzle**

GUN3000



HOSE3000-10



TURBON3000



LANCE3000

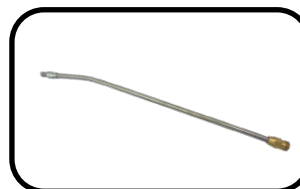

LANTURBO3000

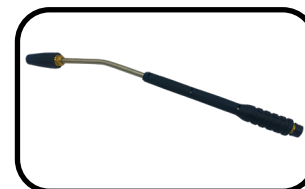

### Pressure Washer

Code	Description	Weight	Engine	Max Pressure	Max Flow	Hose length	Pump	Barcode
MFPW3000-HD	Masterfinish Pressure Washer	32kg	Honda GX200	3200psi	11.9lpm	10m	Gear driven	9318428116021

### Spare Parts

Description	Barcode
LANTURBO3000 Lance with Turbo nozzle	9318428115215
LANCE3000 Lance with 15 deg nozzle	9318428115208
TURBON3000 Replacement Turbo nozzle	9318428115246
GUN3000 Replacement Gun	9318428115222
HOSE3000-10 Replacement 10m Hose	9318428115253



# PRESSURE WASHER



POWERED by HONDA™

**CODE MFPW4000-HD**



**Masterfinish 4000psi pressure washer**

Using a high-flow gear driven pump, the MFPW4000-HD provides a maximum 4300psi of pressure with a flow rate of 14.3LPM. Powered by a Honda GX390 engine, the gear driven pump is a more reliable and stable platform than other direct drive pressure washers.

Heavy-Duty gun and lance with turbo nozzle, 15m hose length.  
Hot dipped galvanised frame.

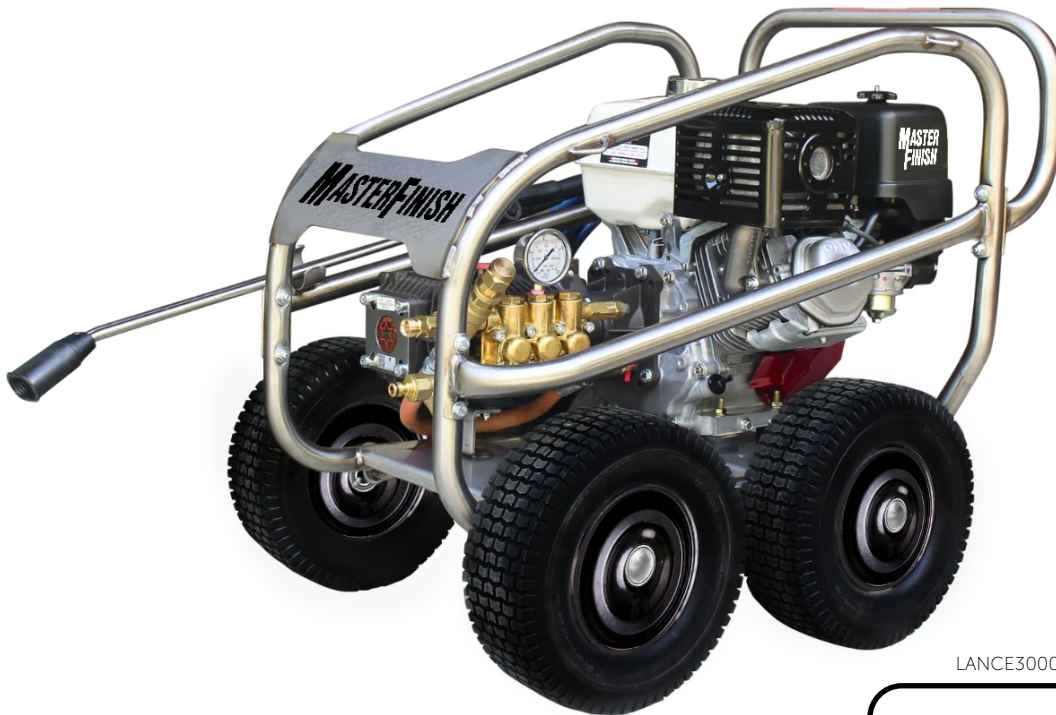

*Supplied with stainless steel lance & turbo nozzle as well as a separate lance with 15 degree nozzle*

GUN4000



HOSE4000-15



TURBON4000



LANCE3000

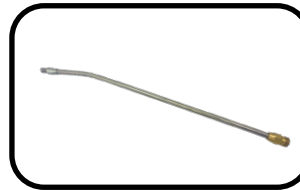

LANTURBO4000

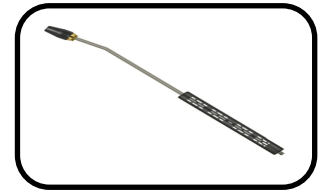

**Pressure Washer**

Code	Description	Weight	Engine	Max Pressure	Max Flow	Hose length	Pump	Barcode
MFPW4000-HD	Masterfinish Pressure Washer	110kg	Honda GX390	4300psi	14.3lpm	15m	Gear driven	9318428116038

**Spare Parts**

Description	Barcode
LANTURBO4000 Lance with Turbo nozzle	9318428116090
LANCE3000 Lance with 15 deg nozzle	9318428115208
TURBON4000 Replacement Turbo nozzle	9318428116113
GUN4000 Replacement Gun	9318428116052
HOSE4000-15 Replacement 15m Hose	9318428116069



# FLOOR GRINDER



by A.G.Pulie Pty Ltd

The Masterfinish Floor Grinder has a robust steel construction and is powered by a 2hp single phase electric motor. Fitted with a 25 metre electric cable and lifting bar. A vacuum hose can be connected to the machine for dust extraction. Fabric dust shield included as standard. Ease of control achieved by using the finger-light wheel height adjustment. Can be fitted with a variety of abrasive segments to suit most applications.

### Minimal maintenance required

2 grease points only.

12 month machine warranty.

Grinding stones not included.



WBGP



29

**12-month** machine warranty

### Floor Grinders

Code	Description	Weight	Motor Size (KW)	Motor Voltage (V)	Disc Speed (RPM)	Disc Diameter (mm)	Vacuum Port Size	Number of Segments	Lead Length	Barcode
G1-A	Single Disc Floor Grinder	83kg	1.5	240	360	350	38	3	25	9318428101584
G2-5-SET	Set of 6, Retainer Strips w/screws	N/A	N/A	N/A	N/A	N/A	N/A	N/A	N/A	9318428102895
12-17	Dust Skirt For G1-A	N/A	N/A	N/A	N/A	N/A	N/A	N/A	N/A	9318428107159
G1A020	Abrasive Mounting Disc	N/A	N/A	N/A	N/A	N/A	N/A	N/A	N/A	9318428106640

### Grinding Blocks

Code	Description	Grit	Length (mm)	Long End (mm)	Short End (mm)	Quantity per machine	Barcode
29	Wedge Abrasive Segment	16	90	78	60	3	9318428106718
29-24	Wedge Abrasive Segment	24	96	78	60	3	9318428111323
29-36	Wedge Abrasive Segment	36	96	78	60	3	9318428106602
WBGP	Diamond Abrasive Segment	Med	96	76	58	3	9318428101690





# VIBRATING SCREED

*Easymix*

The Easymix vibrating screeds are powered by the Honda GX35 mini 4-stroke engine. Available with beams ranging from 1.5 to 4 metres. Vibrating Screeds are made with multi-point adjustable acceleration and a transmission system with centrifugal clutch. The screed bar and frame are manually separated for ease of transport whilst the handles fold down for increased storage space.

The motor is raised from ground level to avoid damage and excessive amounts of concrete and dirt damaging the motor whilst the semi-rigid transmission absorbs horizontal and vertical oscillations.

**12 month machine warranty**  
**36 month Honda warranty.**  
**Australia only.**

**POWERED by HONDA™**

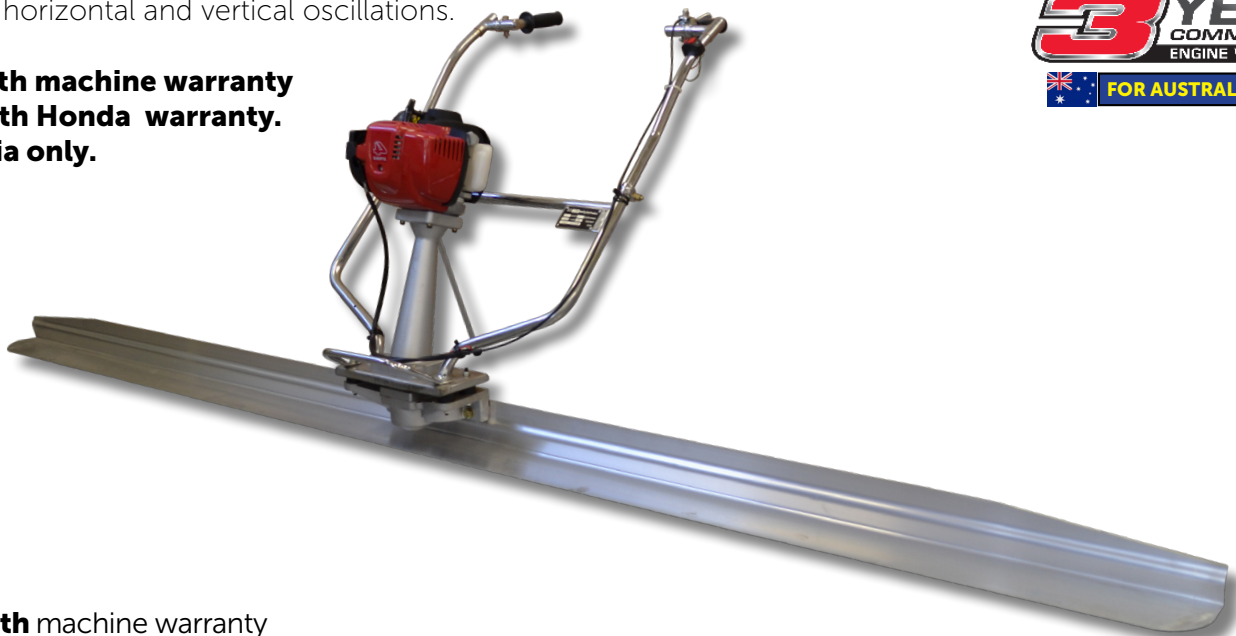

**12-month machine warranty**

## Walk Behind Vibrating Screeds

Code	Description	Weight (kgs)	Length (mm)	Engine	Blade Size (mm)	Barcode
EVS24H	2.4m Vibrating Screed	18	2400	Honda GX35	120 x 2500mm	9318428105230
EVS3H	3m Vibrating Screed	22	3000	Honda GX35	120 x 3000mm	9318428105247
EVS36H	3.6m Vibrating Screed	24	3600	Honda GX35	120 x 3600mm	9318428114201
EVS42H	4.2m Vibrating Screed	28	4200	Honda GX35	120 x 4200mm	9318428106909

## Technical Specs

Engine	Fuel	Power (KW)	Horse Power (HP)	Capacity (CC)	Frequency (VPM)	Centrifugal Force (N)	Motor Oil Capacity (ml)
GX35	4-Stroke	1.0	1.3	35.8	9000	2.0	100

## Replacement Blades

Code	Description	Length (m)	Width (cm)	Weight (kgs)	Barcode
EVS24	Replacement Beam for EVS24H	2400	120	8	9318428106039
EVS3	Replacement Beam for EVS3H	3000	120	12	9318428106947
EVS36	Replacement Beam for EVS36H	3600	120	14	9318428110487
EVS42	Replacement Beam for EVS42H	4200	120	16	9318428111316

# TWIN BEAM SCREED

**MASTER FINISH**  
by A.G.Pulvie Pty Ltd

Applications include roadways, airport aprons, slipways, spillways, tilt panels and warehouse floors. The heavy-duty maintenance-free vibration unit coupled with the powerful GX200 Honda 4-stroke allows you to vibrate and screed large slabs with one pass.

The vibrating screed is controlled by both the vibration propelling the machine forward and the two guide ropes on either end to keep the screed straight. Comes equipped with soft grip handles on either end for lifting and moving around site. Large one-piece motor and exciter cradle for better vibration transfer to the beams. High quality exciter. Australian made to last longer in the toughest of environments.

POWERED by **HONDA**™

**3 YEAR**  
COMMERCIAL  
ENGINE WARRANTY  
FOR AUSTRALIA ONLY

**GX**  
Engine **3**  
YEAR WARRANTY



Available in a **Diesel** option using a **Yanmar L48N 4.7hp motor**. Lengths made to order.

**6-month** machine warranty

**LENGTH** 6.5m maximum length

**Vibrating Screeds**

Code	Description	Engine	Weight (kgs)	Length (mm)	Motor Mounts	Frequency (v.p.m)
2BVS3.25	Twin Beam Screed	Honda GX200	76	3250	Rubber	4500
2BVS4.1	Twin Beam Screed	Honda GX200	84	4100	Rubber	4500
2BVS4.1D	Twin Beam Screed	Yanmar Diesel	84	4100	Rubber	4500
2BVS6.5	Twin Beam Screed	Honda GX200	132	6500	Rubber	4500
2BVS6.5D	Twin Beam Screed	Yanmar Diesel	132	6500	Rubber	4500

**Technical Specs**

Code	Force (KN)	Beam Size (mm)	Engine	Power (kw)	Horse Power (HP)	Capacity (CC)
2BVS Screeds	2.7	50*150 (3mm Thick)	Honda GX200 or Yanmar L48	4.1	5.5	200



Easymix

# BRICKSAW

The Easymix heavy-duty bricksaw runs on either a 1700W single phase motor or Honda GX200 4-stroke engine. The frame is coated with a heavy-duty zinc finish and fitted with a foot control for ease of use.

POWERED by **HONDA**™

The bricksaw has a mobile stand which one person can load and has high quality NSK bearings in the wheels for increased reliability.

**3** YEAR COMMERCIAL ENGINE WARRANTY FOR AUSTRALIA ONLY

Featuring a **heavy-duty tilt guide** and **mitre guide** which is fully adjustable.

Blade Not Included.

SUITS  
**14"**  
BLADES



**12-month** machine warranty

## Bricksaws

Code	Description	Max Cut Depth	Max Cut Length	Weight	Engine	Barcode
BS100E	Electric Bricksaw	125mm	500mm	85kg	1700w Single Phase motor	9318428100297
BS100P	Petrol Bricksaw	125mm	500mm	85kg	Honda GX200 4-stroke	9318428100303





*Easymix*

# BRICKSAW

The Easymix heavy-duty bricksaw runs on either a 1700W single phase motor or Honda GX200 4-stroke engine. The frame is powder coated and fitted with a foot control for ease of use.

**POWERED by HONDA™**

The bricksaw has a mobile stand which one person can load and has high quality NSK bearings in the wheels for increased reliability.

**3 YEAR COMMERCIAL ENGINE WARRANTY**

Featuring a **heavy-duty tilt guide** and **mitre guide** which is fully adjustable.

Blade Not Included

Available in both  
**14 & 16"**  
SIZES



**12-month** machine warranty

## 14" Bricksaws

Code	Description	Max Cut Depth	Max Cut Length	Weight	Engine	Barcode
EM14SAWE	14" Electric Bricksaw	125mm	450mm	85kg	1700w Single Phase motor	9318428113457
EM14SAWP	14" Petrol Bricksaw	125mm	450mm	85kg	Honda GX200 4-stroke	9318428113471

## 16" Bricksaws

Code	Description	Max Cut Depth	Max Cut Length	Weight	Engine	Barcode
EM16SAWE	16" Electric Bricksaw	145mm	550mm	85kg	1700w Single Phase motor	9318428113464
EM16SAWP	16" Petrol Bricksaw	145mm	550mm	85kg	Honda GX200 4-Stroke	9318428113488



*Easymix*

# BLOCKSAW

Introducing the Easymix electric 20" blocksaw. The frame is powder coated for durability and includes a foot control for ease of use. Powered by a heavy-duty TECO 2.2kw electric motor. Stand and saw separates for easy transport. Built tough for Australian conditions.

**POWERED by HONDA™**

**3 YEAR COMMERCIAL ENGINE WARRANTY**

Featuring a **heavy duty mitre guide and water cooling attachment**

Blade Not Included

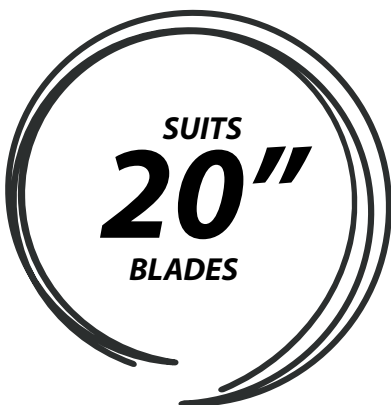

**12-month machine warranty**

## 20" Blocksaw

Code	Description	Max Cut Depth	Max Cut Length	Weight	Engine	Barcode
EM20SAW-E	20" Electric Blocksaw	200mm	540mm	143kg	2.2kw 240v electric motor	9318428114768
EM20SAW-P	20" Petrol Blocksaw	200mm	540mm	143kg	Honda GX270 4-Stroke	9318428114775



# MASTER FINISH H-SERIES



The HS Trowel Machine is powered by the genuine Honda GX200 4-stroke engine and is fitted with a heavy-duty gearbox and base assembly. Height adjustable handle bar stem and lifting hook as standard.

**12 month machine warranty.**  
**36 month Honda warranty. Australia only.**

POWERED by  
**HONDA**



H-Series					
Code	Description	Weight (kgs)	Engine	Path	Barcode
HS34-18	HS Series Trowel Machine	70	Honda GX200	34"	9318428100709
HS40-18	HS Series Trowel Machine	72	Honda GX200	40"	9318428100693

Technical Specs							
Code	Fuel	Power (kw)	Horse Power (hp)	Capacity (CC)	Engine Speed (RPM)	Motor Oil Level (ml)	Gearbox Oil
HS34-18	4-stroke	4.1	5.5	200	3600	600	220 Grade Gear oil
HS40-18	4-stroke	4.1	5.5	200	3600	600	220 Grade Gear oil

Replacement Blades						
Code	Suits	Brand	Description	Size	Bolt Size	Barcode
S34-18PRE	HS34-18	MF Premium	Combination Blade	322 x 203mm	3/8 BSW	9318428333190
S40-18PRE	HS40-18	MF Premium	Combination Blade	375 x 203mm	3/8 BSW	9318428404197
MF40CB	HS40-18	MasterFinish	Combination Blade	375 x 203mm	3/8 BSW	9318428104264
MF34CB	HS34-18	Masterfinish	Combination Blade	322 x 203mm	3/8 BSW	9318428104233
MF34FB	HS34-18	Masterfinish	Finishing Blade	324 x 152mm	3/8 BSW	9318428403435
MF40FB	HS40-18	Masterfinish	Finishing Blade	375 x 203mm	3/8 BSW	9318428111040





# MASTER FINISH POLE TROWEL MACHINE

**MASTER  
FINISH**  
by A.G.Pulie Pty Ltd

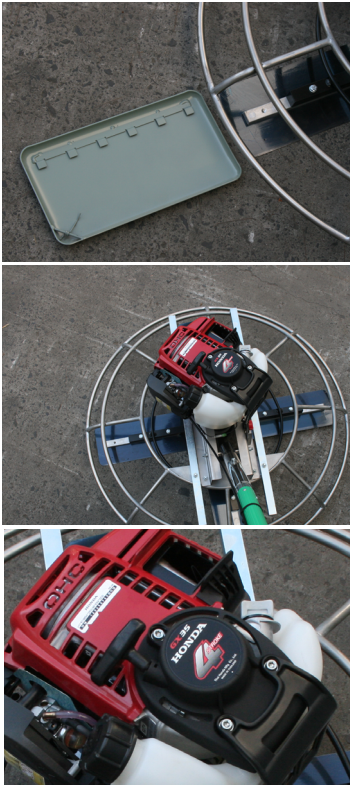

**CODE MFPT28**



**3 YEAR**  
COMMERCIAL  
ENGINE WARRANTY  
FOR AUSTRALIA ONLY

**POWERED by  
HONDA™**

MFPT28

- Utilises a rugged and dependable Honda GX35 motor, coupled to a heavy duty orbital gearbox.
- With 14kg lightweight nature, the machine enables usage up to 30-min after bleed water has evaporated.
- Trowel machine speeds from 25 to 70rpm.
- Comes complete with 1 telescopic handle, giving a span of 2.7-5m.
- Clip on coving blades also supplied with the machine, as are removable weight bars.
- Minimal maintenance required

## Technical Specs

Code	Fuel	Power (KW)	Horse Power (HP)	Capacity (CC)	Engine Speed (RPM)	Motor Oil Level (ml)	Barcode
MFPT28	4-stroke	4.1	1 HP - 0.7kw	35.8	7000	100	9318428104998

## Replacement Blades

Code	Brand	Description	Size	Bolt Size	Barcode
MFPT28B	MasterFinish	Finishing Blade	265 x 120mm	6mm	9318428106114
MFPT28CO	MasterFinish	Clip On Float Blades	288 x 160mm	6mm	9318428106121



# MASTERFINISH MF-SERIES

**MASTER  
FINISH**  
by A.G.Pulvie Pty Ltd

**CODE MF424**

The Masterfinish edging trowel machines are powered by the genuine Honda GX200 4-stroke and fitted with a rotating ring which allows you to finish close to walls and other structures.

The edging machines also feature deadman switches for increased safety, lifting hook, folding handles for ease of transport along with handles located at the front and back of the machine to help manual handling. Local parts and service.

12 month machine warranty.

36 month Honda warranty, Australia only.

**Comes with a floating pan included.**



**MASTER  
FINISH**  
by A.G.Pulvie Pty Ltd

**3 YEAR**  
COMMERCIAL  
ENGINE WARRANTY  
FOR AUSTRALIA ONLY

**POWERED by  
HONDA™**

## MF-Series

Code	Description	Weight (kgs)	Engine	Blade Type	Path	Barcode
MF424	Masterfinish 24" Trowel Machine	70	Honda GX200	MF24FB	24"	9318428104240

## Technical Specs

Code	Fuel	Power (KW)	Horse Power (HP)	Capacity (CC)	Engine Speed (RPM)	Motor Oil Level (ml)	Gearbox Oil
MF424	4-stroke	4.1	5.5	200	3600	600	220 Grade Gear oil

## Replacement Blades

Code	Suits	Brand	Description	Size	Bolt Size	Barcode
MF24FB	MF424/ MF430-6	MasterFinish	Finishing Blade	227 x 120mm	1/4UNC	9318428110739
T600P	MF424	MasterFinish	Float Pan	600mm		9318428113174



# MASTER FINISH MF-SERIES

**MASTER  
FINISH**  
by A.G.Pulie Pty Ltd

**CODE MF430-6**

The Masterfinish edging trowel machines are powered by the genuine Honda GX200 4-stroke and fitted with a rotating ring which allows you to finish close to walls and other structures.

The edging machines also feature deadman switches for increased safety, lifting hook, folding handles for ease of transport along with handles located at the front and back of the machine to help manual handling. Local parts and service.

**12 month machine warranty.**  
**36 month Honda warranty, Australia only.**

*Comes with a floating pan included.*



**MASTER  
FINISH**  
by A.G.Pulie Pty Ltd

**3 YEAR**  
COMMERCIAL  
ENGINE WARRANTY  
FOR AUSTRALIA ONLY

**POWERED by  
HONDA™**

## MF-Series

Code	Description	Weight (kgs)	Engine	Blade Type	Path	Barcode
MF430-6	Masterfinish 30" 6 Blade Trowel Machine	78	Honda GX200	MF24FB	30"	9318428106527

## Technical Specs

Code	Fuel	Power (KW)	Horse Power (HP)	Capacity (CC)	Engine Speed (RPM)	Motor Oil Level (ml)	Gearbox Oil
MF430-6	4-stroke	4.1	5.5	200	3600	600	220 Grade Gear oil

## Replacement Blades

Code	Suits	Brand	Description	Size	Bolt Size	Barcode
MF24FB	MF424/ MF430-6	MasterFinish	Finishing Blade	227 x 120mm	1/4UNC	9318428110739
30PAN6	MF430-6	Masterfinish	Float Pan	755mm		9318428110203



# MASTERFINISH MF-SERIES

**MASTER  
FINISH**  
by A.G.Pulie Pty Ltd

## PREMIUM TROWEL MACHINE

The MF series trowel machines are powered by genuine Honda motors and come with a full powder coated frame.

This machine also features an emergency kill switch for operator safety if the handle is released during trowelling, a lifting hook and fine pitch control for easy blade adjustment

Heavy-Duty gearbox capable of fine finishing and pan work.

**12 month machine warranty.**  
**36 month Honda warranty, Australia only.**

Also available with Yanmar Diesel engine fitted.



### MF-Series

Code	Description	Weight (kgs)	Engine	Path	Barcode
MF436	MF Series Trowel Machine	77	Honda GX200	36"	9318428104363
MF436D	MF Series Diesel Trowel Machine	78	Yanmar L48N	36"	9318428109191
MF436-270	MF Series Trowel Machine	86	Honda GX270	36"	9318428115871
MF440D	MF Series Trowel Machine	78	Yanmar L48N	40"	9318428109207
MF440-200	MF Series Trowel Machine	80	Honda GX200	40"	9318428105100
MF440-270	MF Series Trowel Machine	89	Honda GX270	40"	9318428993486

### Technical Specs

Code	Fuel	Power (KW)	Horse Power (HP)	Capacity (CC)	Engine Speed (RPM)	Motor Oil Level (ml)	Gearbox Oil
MF436	4-stroke	4.1	5.5	200	3600	600	220 Grade Gear Oil
MF436D	Diesel	4.1	5.5	200	3600	600	220 Grade Gear Oil
MF436-270	4-Stroke	7	9	270	3600	1100	220 Grade Gear Oil
MF440-270	4-stroke	7	9	270	3600	1100	220 Grade Gear Oil
MF440-200	4-stroke	4.1	5.5	200	3600	600	220 Grade Gear Oil

### Replacement Blades

Code	Suits	Brand	Description	Size	Bolt Size	Barcode
S36-10P	MF436/MF440	MF Premium	Combination Blade	355 x 203mm	5/16 UNC	9318428403640
MF36CB	MF436/MF440	MasterFinish	Combination Blade	355 x 203mm	5/16 UNC	9318428104271
MF36FB	MF436/MF440	MasterFinish	Finishing Blade	355 x 152mm	5/16 UNC	9318428104332
BO38.5	MF436/MF36H	MasterFinish	Float Pan	940mm	N/A	9318428102758
BO-41	MF440	MasterFinish	Float Pan	1050mm	N/A	9318428105087



# MASTERFINISH MF-SERIES

**MASTER  
FINISH**  
by A.G.Pulie Pty Ltd

**CODE MF36H**

MF36H trowel machine powered by the Honda GP200 engine.

Heavy-Duty gearbox, powder coated frame and adjustable handle. Fine pitch adjustment and rack & pinion style throttle control.

**12 month machine warranty.**  
**12 month Honda warranty.**



**POWERED by  
HONDA**

## MF-Series

Code	Description	Weight (kgs)	Engine	Path	Barcode
MF36H	Masterfinish 36" Trowel Machine	77	Honda GP200	36"	9318428111644

## Technical Specs

Code	Fuel	Power (KW)	Horse Power (HP)	Capacity (CC)	Engine Speed (RPM)	Motor Oil Level (ml)	Gearbox Oil
MF36H	4-stroke	4.1 kw	5.5 hp	200cc	3600	600ml	220 grade gear oil

## Replacement Blades

Code	Suits	Brand	Description	Size	Bolt Size	Barcode
S36-10P	MF36H	MF Premium	Combination Blade	355 x 203mm	5/16 UNC	9318428403640
MF36CB	MF36H	MasterFinish	Combination Blade	355 x 203mm	5/16 UNC	9318428104271
MF36FB	MF36H	MasterFinish	Finishing Blade	355 x 152mm	5/16 UNC	9318428104332
BO36	MF36H	MasterFinish	Float Pan	940mm	N/A	9318428113495

# MASTER FINISH MF-SERIES

**MASTER  
FINISH**  
by A.G.Pulie Pty Ltd



**CODE MF446**



The MF series trowel machines are powered by genuine Honda motors and come with a full powder coated frame.

This machine also features an emergency kill switch for operator safety if the handle is released during trowelling, a lifting hook and fine pitch control for easy blade adjustment

**12 month machine warranty.**  
**36 month Honda warranty, Australia only.**

Also available with Yanmar Diesel engine fitted.

**POWERED by  
HONDA™**

**3 YEAR  
COMMERCIAL  
ENGINE WARRANTY**  
FOR AUSTRALIA ONLY

MF-Series						
Code	Description	Weight (kgs)	Engine	Path	Barcode	
MF446	MF Series Trowel Machine	116	Honda GX270	46"	9318428105896	
MF446D	MF Series Diesel Trowel Machine	116	Yanmar L48	46	9318428102239	

Technical Specs							
Code	Fuel	Power (KW)	Horse Power (HP)	Capacity (CC)	Engine Speed (RPM)	Motor Oil Level (ml)	Gearbox Oil
MF446	4-stroke	6.7	9	270	3600	1100	220 Grade Gear Oil
MF446D	Diesel	4.1	5.5	200	3600	600	220 Grade Gear Oil

Replacement Blades							
Code	Suits	Brand	Description	Size	Bolt Size	Barcode	
S46-18P	MF446	MF Premium	Combination Blade	456 x 203mm	5/16 UNC	9318428406191	
MF46CB	MF446	MasterFinish	Combination Blade	456 x 203mm	5/16 UNC	9318428110746	
MF46FB	MF446	MasterFinish	Finishing Blade	457 x 152mm	5/16 UNC	9318428112221	





# MASTER FINISH MF-SERIES

**MASTER  
FINISH**  
by A.G.Pulie Pty Ltd

**CODE MF836-HR**

Featuring lifting points as standard, stainless steel fuel and water tank with large cap along with a guard ring and fitted with work lights.

140-150rpm blade speed for final finishing.

**12 month machine warranty.**  
**36 month Honda warranty.**



**3 YEAR**  
COMMERCIAL  
ENGINE WARRANTY  
FOR AUSTRALIA ONLY

**POWERED by**  
**HONDA**

MF-Series						
Code	Description	Weight (kgs)	Engine	Blade Type	Path	Barcode
MF836-HR	Masterfinish High Rider Ride-On trowel machines	330	Honda GX690	MF36FB/MF36CB	1880mm	9318428112634

Technical Specs							
Code	Fuel	Power (KW)	Horse Power	Capacity (CC)	Engine Speed (RPM)	Motor Oil Level (ml)	Gearbox Oil
MF836-HR	4-stroke	13	22.1	688	3600	2000	220 Grade Gear oil

Replacement Blades						
Code	Suits	Brand	Description	Size	Bolt Size	Barcode
S36-10P	MF836-HR	MF Premium	Combination Blade	355 x 203mm	5/16 UNC	9318428403640
MF36CB	MF836-HR	MasterFinish	Combination Blade	355 x 203mm	5/16 UNC	9318428104271
MF36FB	MF836-HR	MasterFinish	Finishing Blade	355 x 152mm	5/16 UNC	9318428104332
BO38.5	MF836-HR	MasterFinish	Float Pan	940mm	N/A	9318428102758



# TROWEL MACHINE BLADES

Masterfinish Blades are manufactured using **specialy formulated hardened** and **tempered spring steel**. The high carbon content provides abrasion resistance for longer wear.

## Trowel Machine Blades

Blade	Codes	Bolt Size	Description	Suits
	S34-18PRE MF34CB	<b>3/8 BSW</b> 4pcs 2" 4pcs 1.5"	<b>Combination Blades</b> Blade Size - 322mm x 203mm Hole centres - 152mm Weight - 6kg	HS34-18
	S40-18PRE MF40CB	<b>3/8 BSW</b> 4pcs 2" 4pcs 1.5"	<b>Combination Blades</b> Blade Size - 375mm x 203mm Hole Centres - 152mm Weight - 8kg	HS40-18
	MF34FB	<b>3/8 BSW</b> 4pcs 2" 4pcs 1.5"	<b>Finishing Blades</b> Blade Size - 324mm x 152mm Hole Centres - 152mm Weight - 4.5kg	HS34-18
	MF40FB	<b>3/8 BSW</b> 4pcs 2" 4pcs 1.5"	<b>Finishing Blades</b> Blade Size - 375mm x 152mm Hole Centres - 152mm Weight - 5kg	HS40-18
	S36-10P MF36CB	<b>5/16 UNC</b> 4pcs 2" 4pcs 1.5"	<b>Combination Blades</b> Blade Size - 355mm x 203mm Hole Centres - 120mm Package Weight - 8kg	MF436 MF440 MF36H MF836-HR
	MF36FB	<b>5/16 UNC</b> 4pcs 2" 4pcs 1.5"	<b>Finishing Blades</b> Blade Size - 355mm x 152mm Hole Centres - 120mm Package Weight - 4.5kg	MF436 MF440 MF36H MF836-HR
	S46-18P MF46CB	<b>5/16 UNC</b> 4pcs 2" 8pcs 1.5"	<b>Combination Blades</b> Blade Size - 457mm x 152mm Hole Centres - 66/90/30mm Package Weight - 10kg	MF446



# TROWEL MACHINE BLADES

Masterfinish Blades are manufactured using **specially formulated hardened** and tempered **spring steel**. The high carbon content provides abrasion resistance for longer wear.

## Trowel Machine Blades

Blade	Codes	Bolt Size	Description	Suits MF Machine
	MF46FB	<b>5/16 UNC</b> 4pcs 2" 8pcs 1.5"	<b>Finishing Blades</b> Blade Size - 457mm x 152mm Hole Centres - 66/90/30mm Package Weight - 7kg	MF446
	MF24FB	<b>1/4 UNC</b> 8pcs 1.5"	<b>Finishing Blades</b> Blade Size - 227mm x 120mm Hole Centres - 100mm Package Weight - 3kg	MF424 MF430-6 MF630
	BF36B	<b>Clip On</b>	<b>Premium Clip On Float Blades</b> Blade Size - 355mm x 254mm Package Weight - 9.3kg	MF436 MF440
	BF46B	<b>Clip On</b>	<b>Premium Clip On Float Blades</b> Blade Size - 457mm x 254mm Package Weight - 12.5kg	MF446
	PL0090	<b>5/16 UNC</b> 4pcs 2" 4pcs 1.5"	<b>Plastic Finishing Blades</b> Blade Size - 355mm x 152mm Hole Centres - 120mm Weight - 4.5kg	MF436 MF440 MF36H
	PL0091	<b>5/16 UNC</b> 4pcs 2" 8pcs 1.5"	<b>Plastic Finishing Blades</b> Blade Size - 457mm x 152mmww Hole Centres - 66/90/30mm Weight -5.6kg	MF446





# MACHINERY REPLACEMENT PARTS

## HandyVibe Parts

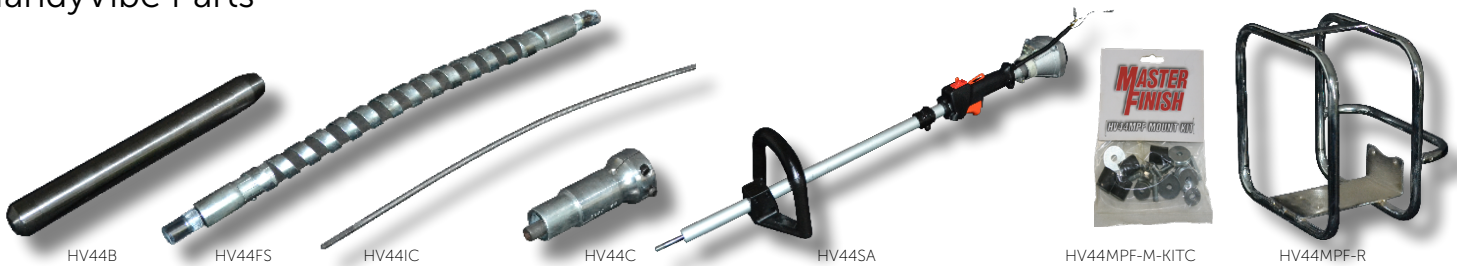

HV44B

HV44FS

HV44IC

HV44C

HV44SA

HV44MPF-M-KITC

HV44MPF-R

## Drive Unit Parts



K7160

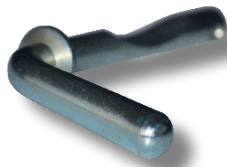

K7159



K7161

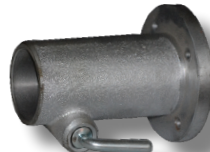

K4872

## Compactor Parts



550-10

### Spare Parts

Code	Machine	Description
HV44B	Handyvibe	HandyVibe Barrel Assembly
HV44C	Handyvibe	Coupling HV44
HV44FS	Handyvibe	Flex Shaft Assy For HV44
HV44MPF-R	Handyvibe	Motor Protection Frame
HV44MPF-M-KITC	Handyvibe	Vibration Mount Kit
HV44SA	Handyvibe	Handyvibe Stem Assy
HV44IC	Handyvibe	Inner Core
K7160	Drive Unit	Spring Kit
K7161	Drive Unit	3/4" Bore Drive Dog
K4872	Drive Unit	Bell Housing
K7159	Drive Unit	Trigger Kit
550-10	Plate Compactor	Vibration Mounts



# MACHINERY REPLACEMENT PARTS

## Grinder Parts



G2-5



12-17

## Trowel Machine Pans



T600P



30PAN6

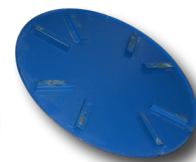

BO38.5



BO-41

## Motor Covers



M/COVER - Small

M/COVER - Medium



M/COVER

Spare Parts		
Code	Machine	Description
M/COVER - Small	Handyvibe	Motor cover to suit HV44E
M/COVER - Medium	Handyvibe	Motor cover to suit HV44 with Cage
M/COVER - Large	Trowel Machine	Motor cover
T600P	24" Trowel Machine	24" Floating Pan
30PAN6	30" Trowel Machine	30" Floating Pan
BO38.5	36" Trowel Machine	38" Floating Pan
BO48.5	Ride-On Machines Only	48" Floating Pan
BO-41	40"MF Trowel Machine	For use with the MF440-270 & MF440-200 machine
G2-5-SET	Grinder	Retainer Strips
12-17	Grinder	Dust Skirt



# MB22 HANDYMAN MIXER (DIY)

# HANDY MIX

**CODE MB22**



The MB22 2.2Cft Cement Mixer is made with a 3-piece tubular steel frame and is fitted with a poly motor cover and poly rimmed pneumatic tyres.

The bowl is seam welded, containing six beaters and has a maintenance-free ball-bearing head for the pinion and bowl.

### Dimensions

1010 x 1400 x 1580mm

**Requires assembly.**

**3 months machine warranty.**

**NOTE** This is not a trade level mixer

**3-month** machine warranty

Cement Mixers					
Code	Description	Engine Type	Size (cft)	Weight	Barcode
MB22	2.2 DIY Mixer	1/2 HP 240V 1440rpm Single Phase Engine	2.2	65kg	9318428101461





*Easymix*

# TRADE MIXERS

**HEAVY DUTY**

**CODE LEM22**

The LEM 2.2Cft Cement Mixer is made with a heavy-duty tubular steel frame and fitted with steel Pneumatic wheels.

The bowl is seam welded with six heavy-duty beaters inside and has a maintenance-free ball-bearing head for pinion and bowl.

**12 month machine warranty.**

- Extra HD Construction
- Pneumatic tyres
- Steel belt cover
- Electric motor



**12-month machine warranty. 6-month motor**

**Cement Mixers**

Code	Description	Engine Type	Weight	Size (cft)	Barcode
LEM22	2.2 Cft Heavy-duty mixer	Electric	65kg	2.2	9318428111064



# TRADE MIXER

**CODE LEM35**

The LEM 3.5Cft Cement Mixer is made with a heavy-duty tubular steel frame and fitted with steel Flat Free wheels.

The bowl is seam welded with six heavy-duty beaters inside and has a maintenance-free ball-bearing head for pinion and bowl.

**12 month machine warranty.**

**HEAVY DUTY**



- Extra HD Construction
- Flat Free tyres
- Stabiliser Legs
- Electric motor

**12-month machine warranty. 6-month motor**

Cement Mixers					
Code	Description	Engine Type	Weight	Size (cft)	Barcode
LEM35	3.5 Cft Heavy-duty mixer	Electric	110kg	3.5	9318428103939



# TRADE MIXER

**CODE LEM35H**

The LEM 3.5Cft Cement Mixer is made with a heavy-duty tubular steel frame and fitted with steel Flat Free wheels

The bowl is seam welded with six heavy-duty beaters inside and has a maintenance-free ball-bearing head for pinion and bowl.

**12 month machine warranty.**

**HEAVY DUTY**



- Extra HD Construction
- Flat Free tyres
- Stabiliser Legs
- Honda GX120 Petrol engine

POWERED by **HONDA**

**3** YEAR COMMERCIAL ENGINE WARRANTY

**12-month machine warranty. 36-month HONDA warranty**

Cement Mixers					
Code	Description	Engine Type	Weight	Size (cft)	Barcode
LEM35H	3.5 Cft Heavy-duty mixer With Honda Eng	Petrol	110kg	3.5	9318428102970





# TRADE MIXER

# BARROMIX

**CODE** **BM35**

These heavy duty mixers are precision engineered throughout and have set the standard for the construction industry. They are easy to handle and extra sturdy for bricks due to the fixed axle.

**12 month warranty**



BM35



**NOTE** Mixer is unassembled

## Cement Mixers

Code	Description	Engine Type	Weight	Size (cft)	Barcode
BM35	Barrow Mixer 3.5CFT	1/2 HP Electric Motor (240V)	65	3.5	9318428104400



# TRADE MIXER

*Easymix*

**CODE** **EM120**

The EM120 Paddle Mixer runs on a single phase voltage engine. Its ergonomic designed frame increases maneuverability, including its ability to fit through narrow door ways.

Equipped with multiple exchangeable mixing paddles, the EM120 makes the perfect mix in 3-5 minutes. Also features a bag splitter for ease of pouring, telescopic legs for discharge into a bucket or wheelbarrow and small wheels on the back which allow for ease of loading in and out of vehicles.

**12 month warranty**



EM120



**Cement Mixers**

Code	Description	Engine Type	Weight	Size (cft)	Barcode
EM120	Paddle Mixer	Single Phase Voltage (110/240V)	99kg	3.5 - 120L	9318428105124



## Cement Mixers

# TIPUP



Availability *Western Australia only*

### Easymix



TIPUP SHOWN ON SUPPLIED STAND

**Comes standard with a fixed stand;** the fatbowl and swivel stand are optional. Unloads at standard wheelbarrow height when on stand.

- Belt driven cement mixer
- 1hp electric motor
- Poly engine cover
- Extra heavy duty square tube frame
- Extra heavy duty removable steel 2 paddle bowl
- 400x8 heavy duty pneumatic wheels

240V Electric Motor



Honda GX200 Engine



**POWERED by HONDA**

### Cement Mixers

Code	Description	Engine Type	Size (cft)	Weight	Barcode
TIPUP	3.5 Tipup Mixer w/ Fixed Stand	Electric 240V	3.5	95kg	9318428112726
TIPUP-FB	3.5cft Electric Mixer, fat bowl	Electric 240V	3.5	95kg	9318428112740
TIPUP-FB-H	3.5cft Petrol Mixer, fat bowl	Honda GX200 Petrol	3.5	95kg	9318428112757
TIPUP-H	3.5cft Petrol mixer	Honda GX200 Petrol	3.5	95kg	9318428112733
TIPUP-SG	3.5cft Tipup Mixer - Sealed Gearbox	Electric 240V	3.5	95kg	9318428114980
TIPUP-SG-H	3.5cft Tipup Mixer - Sealed Gearbox	Honda GX200 Petrol	3.5	95kg	9318428115321





Cement Mixers

# TIPUP SEALED GEARBOX



Availability *Western Australia only*

*Easymix*

- Sealed Gearbox & Motor
- 1hp electric motor
- Steel engine cover
- Extra heavy duty square tube frame
- Extra heavy duty removable steel 2 paddle bowl
- 400x8 heavy duty pneumatic wheels



**Comes standard with a fixed stand;** the fatbowl and swivel stand are optional. Unloads at standard wheelbarrow height when on stand.

Sealed Motor & Gearbox



TIPUP-DD SHOWN ON SUPPLIED STAND

TIPUP-DD AVAILABLE WITH ELECTRIC MOTOR ONLY

Cement Mixers

Code	Description	Engine Type	Size (cft)	Weight	Barcode
TIPUP-DD	3.5 Bowl Electric Mixer - Direct Drive	Electric 240V	3.5	98kg	9318428115451
TIPUP-DDFB	3.5 Bowl Electric Mixer, fat bowl - Direct Drive	Electric 240V	3.5	98kg	9318428115444



## Cement Mixers

# TUMIX



Availability *Western Australia only*

### Easymix

The TU-MIX mixer is available with either a petrol or electric motor. Built with a heavy-duty frame and bowl and uses Premium NSK bearings. Fitted with steel wheels and FLAT FREE Tyres (16 x 4.00-8).



TU-MIX ON STAND POSITION

**Comes standard with a fixed stand;** the fatbowl and swivel stand are optional. Unloads at standard wheelbarrow height when on stand.

240V Electric Motor



Honda GX200 Engine



**POWERED by HONDA**

**NOTE** Also available with a Honda motor

**12-month** machine warranty. **6-month** motor **36-month** on Petrol engine

### Cement Mixers

Code	Description	Engine Type	Size (cft)	Barcode
TU-MIX	3.5 Tipup Mixer w/ Fixed Stand	240V electric motor	3.5	9012502113926
TU-MIX-7	3.5 Tipup Mixer w/ Swivel Stand	240V electric motor	3.5	9318428112511
TU-MIX-10	3.5 Tipup Mixer w/ Fixed Stand	Honda GX200	3.5	9318428111538
TU-MIX-13	3.5 Tipup Mixer w/ Swivel Stand	Honda GX200	3.5	9318428112467
TU-MIX-FBB	3.5 Plaster Pro Tipup Mixer Fat Bowl w/ Fixed Stand	240V electric motor	3.5	9318428103250
TU35-MOTOR	Replacement Electric Motor	240V electric motor		9318428112931
GX200	Honda GX200 Engine	Honda GX200		9318428106619



# PLATE COMPACTORS



**CODE 490HW**

## 490HW Plate Compactor

The Easymix 490H plate compactor has a solid, high-strength steel base plate with curved edges to provide top performance. The robustly designed sealed belt cover gives great protection to both the clutch and belt. Fitted with anti-vibration removable flip-over handles for easy transportation and wheels for ease of movement around site. Comes standard with sprayer bottle.

**The exciter uses 200ml of 10W-30 motor oil. 12 months machine warranty and 36 months Honda motor warranty, Australia only.**

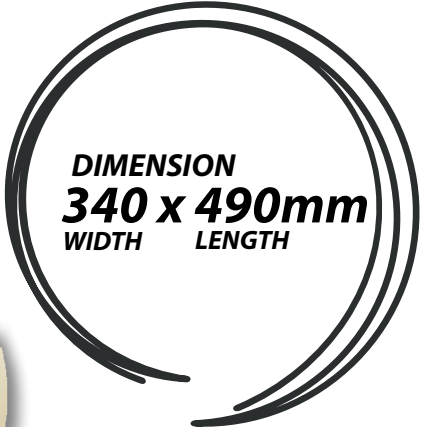

**POWERED by HONDA™**

**3 YEAR COMMERCIAL ENGINE WARRANTY**  
**FOR AUSTRALIA ONLY**

### Plate Compactors

Code	Description	Weight (kgs)	Engine	Plate Width (mm)	Plate Length (mm)	Vibrating System
490HW	Plate Compactor C/W Water Sprayer	65	Honda GX200	340	490	Eccentric Rotation

### Technical Specs

Code	Centrifugal Force (KN)	Frequency (VPM)	Compaction Depth (CM)	Hill Climbing Ability	Motor Oil Capacity
490HW	10	5400	15 Approx	30° Approx	600





# PLATE COMPACTORS



**CODE 550H**

## 550H Plate Compactor

The Easymix 550H plate compactor has a solid, high-strength steel base plate with curved edges which provides top performance. Fitted with a lifting hook and anti-vibration flip over handle for easy transportation. The exciter is front mounted meaning the plate compactor has the ability to pull itself through softer material with greater ease.

**The exciter uses sealed bearings so no need for oiling. 12 month machine warranty and 36 month Honda warranty, Australia only.**



**DIMENSION**  
**500 x 550mm**  
**WIDTH      LENGTH**



**POWERED by HONDA™**



Also available with Yanmar Diesel engine

### Plate Compactors

Code	Description	Weight (kgs)	Engine	Fuel	Plate Width (mm)	Plate Length (mm)	Vibrating System
550H	Plate Compactor	98	Honda GX200	4-Stroke	500	550	Eccentric Rotation
550Y	Plate Compactor	98	Yanmar L48	Diesel	500	550	Eccentric Rotation



# PLATE COMPACTORS

**MASTER  
FINISH**  
by A.G.Pulie Pty Ltd

**CODE 610H**

## 610H Plate Compactor

The Easymix 610H plate compactor features a vibration isolated reversible handle for easy operation and reduced operator fatigue. The heavy-duty shock mounts reduce vibration to the upper engine and handle for more comfortable use. The excitor is centrally mounted and fully enclosed for an even spread of compactive force over the whole base plate.

The excitor is grease filled and should be checked and regreased every 500hrs with Shell Alania R3 grease or equivalent.

**12 month machine warranty and 36 month Honda warranty, Australia only.**

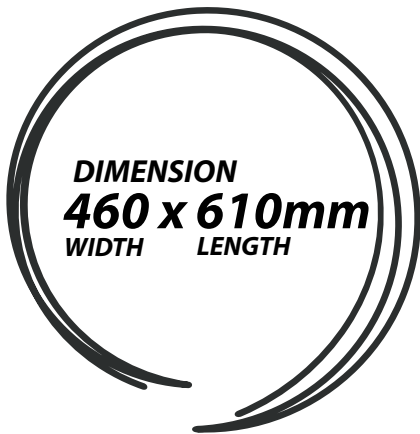

**3 YEAR**  
COMMERCIAL  
ENGINE WARRANTY  
FOR AUSTRALIA ONLY

POWERED by  
**HONDA**

### Plate Compactors

Code	Description	Weight (kgs)	Engine	Fuel	Plate Width (mm)	Plate Length (mm)	Vibrating System
610H	HD Plate Compactor	93	Honda GX200	4-Stroke	460	610	Eccentric Rotation

### Technical Specs

Code	Centrifugal Force (Kn)	Frequency (VPM)	Compaction Depth (cm)	Hill Climbing Ability	Motor Oil Capacity
610H	19.8	7000	30 Approx	20° Approx	600



# TAMPING RAMMER

**CODE** **ER68H**

The Easymix Tamping Rammers are driven by 4-stroke petrol engines designed specially for rammers. No need to mix fuel and oil. Fitted with a heavy-duty gearbox, plastic rust-free oil tank and built-in air filtration system to provide a durable machine with a longer running life.

An integrated fuel valve provides easy starting. The heavy shock mount system reduces hand-arm vibration and improves operator comfort. Also available is a specially designed trolley kit for easy transportation. The Rammer shoe is made of a steel plate with a wooden insert that offers economical usage.

A high quality German-made polyurethane bellow, accepts more compacting force and offers a reliable lubricating system.



- Engine: 163CC 4 Stroke
- Impact Force 13kn
- Fuel: Unleaded (Not E10)
- Power: 4.1kw/5.5hp
- Capacity: 163cc
- Engine Speed: 3600rpm



## Tamping Rammer

Code	Description	Weight	Engine	Power
ER68H	Tamping Rammer	68kg	Honda GX100	2.2kw

## Technical Specs

Code	Vibration Frequency	Impact Force	Jumping Stroke	Foot Size
ER68H	650-695 vpm	1300kg	40-85mm	330 x 285mm





# VERTICAL RAMMER

**CODE** **CTR70B**

163CC  
**4-stroke**



CTR70B

### Vertical Rammer

- Heavy Duty Design
- Foot Mounted Lifting Handle
- Front Loading Wheels
- Plastic Fuel Tank
- Foot Size 330mm x 285mm
- Rubber Isolation Mounts
- Weight: 70kgs

**NOTE** Also available with a Diesel motor

#### Tamping Rammer

Code	Description	Weight	Engine	Power
CTR70B	Tamping Rammer	68kg	163cc 4-Stroke	3kw
CTR70D	Tamping Rammer	85kg	Diesel	3.1kw

#### Technical Specs

Code	Vibration Frequency	Impact Force	Jumping Stroke	Foot Size
CTR70B	650-695 vpm	1300kg	40-85mm	330 x 285mm
CTR70D	640-680 vpm	1427kg	40-85mm	330 x 285mm



# CEMTOOL RANGE

# Cemtool



CTP65BS

### 65KG Plate Compactor

- Built-in site wheels
- Motor protection & Lifting point frame fitted
- Notched throttle control
- Open design steel base plate
- Front Excitor

### Compact Design

Narrow 360mm steel base for tight access or trenches

### Serviceability

- Australian specification for ease of service and parts
- Over 150 Dealers Australia Wide

Briggs & Stratton professional 4 stroke horizontal shaft engines are built to be tough, reliable and efficient. Feature for feature, they offer you the best value available.

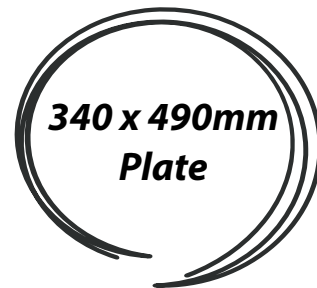

Code	Weight	Engine	Compaction Depth	Fuel	Power KW (HP)	Capacity	Engine Speed
CTP65BS	65kg	B&S XR750	200mm	Unleaded (not e10)	4,1 (5.5)	163	3600 rpm



# CEMTOOL RANGE

# Cemtool



**XR750**  
PROFESSIONAL  
B&S MOTOR



CTP93BS

## 93KG Plate Compactor

- Central located excitor
- Flip over handle bars for tight spots
- Rubber handle and engine isolation mounts for user comfort
- Lifting hook fitted as standard

### Design

Proven and tested popular design

### Serviceability

- Australian specification for ease of service and parts
- Over 150 Dealers Australia Wide

Briggs & Stratton professional 4 stroke horizontal shaft engines are built to be tough, reliable and efficient. Feature for feature, they offer you the best value available.

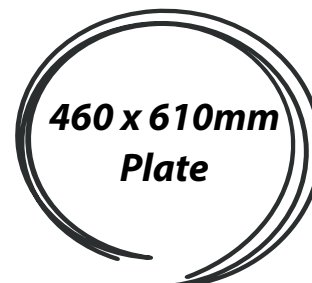

Code	Weight	Engine	Compaction Depth	Fuel	Power KW (HP)	Capacity	Engine Speed
CTP93BS	93kg	B&S XR750	300mm	Unleaded (not e10)	4.1 (5.5)	163	3600 rpm





**A.G PULIE**

# **FORMWORKS**

## **SECTION 5**







# TIE WIRE



## The Masterfinish Wire Reel

Highest quality die-cast aluminium; all steel components offer longer life. Holds 14 to 18 gauge black annealed tie wire, copper covered wire, monel wire, soft galvanized wire or stainless steel wire.

MF309



## The Ideal Reel

Highest quality die-cast aluminium; all steel components offer longer life. Holds 14 to 18 gauge black annealed tie wire, copper covered wire, monel wire, soft galvanized wire or stainless steel wire.

ID309



### Wire Reels

Code	Description	Pack Qty	Barcode
MF309	Masterfinish Wire Reel	10	9318428102499
ID309	Ideal Wire Reel	8	9318428500028

## Masterfinish Tie Wire

High quality 1.57mm annealed tie wire. Designed to fit neatly into tie wire reels for easy dispensing. Made from strong, durable steel wire. Perfect for tying off reinforcing mesh. 95m length



### Tie Wire

Code	Description	Pack Qty	Barcode
MF-TWIRE	Masterfinish Tie Wire	10	9318428115086





**MASTER  
FINISH**  
by A.G.Pulvie Pty Ltd



MCR5



MCR20



MCR75

## Masterfinish Concrete Remover

Masterfinish Concrete Remover is an acid alternative with no fumes or odours. When applied to a dry surface it turns hardest cement back into rinsable mud. M.C.R is completely biodegradable and environmentally safe. Concrete remover will save you money by protecting your equipment from the corrosive effects of concrete and acid cleaners.

Concrete Remover				
Code	Description	Size	Pack qty	Barcode
MCR75	Masterfinish Concrete Remover	0.75ltr	1	9318428990744
MCR5	Masterfinish Concrete Remover	5ltr	1	9318428990812
MCR20	Masterfinish Concrete Remover	20ltr	1	9318428990980

## Rebar Bender

Strong, light, easy and simple to use. Completely portable. Can be used anywhere on the job. 36" length provides enough leverage to bend 5/8" reinforcing bar.



Rebar Bender			
Code	Description	Length	Barcode
MF629	Rebar Bender	900	9318428114928



## MasterFinish Wire Twister - Ratchet

Accurately machined spring return spiral with wear resistant bronze sleeve. Fitted with a heavy-duty, comfort grip handle, high tensile ratchet and leather bumper.



Wire Twister			
Code	Description	Pack Qty	Barcode
MF-90016	Masterfinish Wire Twister - Ratchet	1	9318428113662



## MasterFinish Wire Twister

Compact tie wire twister that is ideal for tight spaces. Durable plastic handle and plated hook. Safely and easily twists looped wire and bar ties



Wire Twister			
Code	Description	Pack Qty	Barcode
MF-TWIST	Masterfinish Wire Twister	1	9318428115864





# BOLT CUTTERS



Featuring a hardened steel jaw the Masterfinish Bolt Cutters are designed for ease of use and user comfort.

Aligned cutting edge reduces the chances of blades chipping and produces an accurate cut each time.

- Hardened Steel Jaw
- Rubber handles
- Aligned cutting edge
- Powdercoated handles

## DISPLAY STAND

QUANTITY OF SIXTEEN (16)



### Masterfinish Bolt Cutters

Code	Description	Weight	Length	Cutting Capacity	Barcode
MFBC-600	Bolt cutter	2.5kg	600mm	10mm - 80HRB Bar	9318428111194
MFBC-750	Bolt cutter	3.85kg	750mm	13mm - 80HRB Bar	9318428111200
MFBC-900	Bolt cutter	5.9kg	900mm	16mm - 80HRB Bar	9318428111217
MFBC-1050	Bolt cutter	8.0kg	1050mm	18mm - 80HRB Bar	9318428111224

### Replacement Jaw Codes

Code	Description	Length	Barcode
MFBC-600	MF Bolt cutter Jaws	600mm	9318428112276
MFBC-750	MF Bolt cutter Jaws	750mm	9318428112269
MFBC-900	MF Bolt cutter Jaws	900mm	9318428112252
MFBC-1050	MF Bolt cutter Jaws	1050mm	9318428112283

### REO Cutter Benders

Code	Description	Weight	Length	Cutting Capacity	Barcode
MFCB-16	Reo Cutter/Bender	17kg	1250mm	16mm	9318428111231
MFCBE-16	Replacement Blade				9318428112245



# BOLT CUTTERS

The MCC Bolt Cutters are adaptable from soft to medium hard materials and makes a quick and easy cut on reinforcing rods and bolts.

The blades are drop forged from alloy tool steel then carefully heat-treated for maximum strength and wear resistance. Unique side adjustment of blades for accuracy.

All tubular handles with ductile handle grips.

Replacement jaws available.



**DISPLAY STAND**

**QUANTITY OF TWENTY (20)**

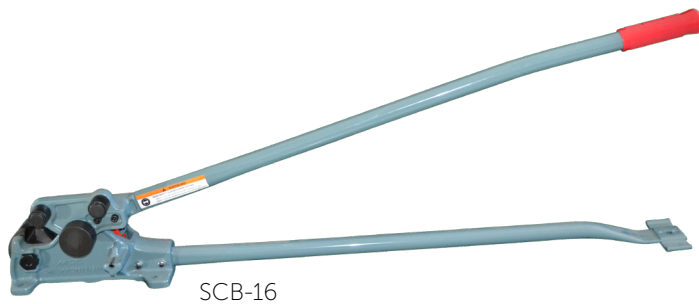
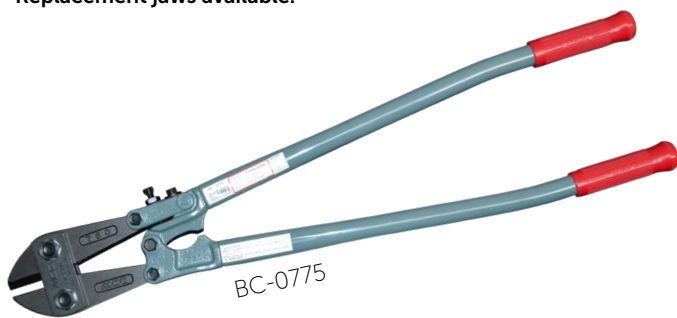

The MCC Reo Cutter Bender is specifically designed for cutting and precision bending of reinforcing rods at 90°, 135° and 180°.

Blades are drop forged from alloy tool steel. Tool can be bolted to floor or timber board for easy operation. Made in Japan.



## Bolt Cutters

Code	Description	Length	Weight	Cutting Capacity (80 HRB Rod)	Cutting Capacity (20 HRC Rod)	Cutting Capacity (36 HRC Rod)	Spare Blade	Pack Qty	Barcode
BC-0745	Alloy tool steel Bolt Cutters	450mm	1.45Kgs	8	8	6	BCE-0045	2	9318428102451
BC-0760	Alloy tool steel Bolt Cutters	600mm	2.5Kgs	10	10	8	BCE-0060	2	9318428102468
BC-0775	Alloy tool steel Bolt Cutters	750mm	3.85Kgs	13	13	10	BCE-0075	2	9318428102475
BC-0790	Alloy tool steel Bolt Cutters	900mm	5.9Kgs	16	14	11	BCE-0090	2	9318428102482
BC-0710	Alloy tool steel Bolt Cutters	1050mm	8.05Kgs	18	16	13	BCE-0010	2	9318428102444
SCB-16	Reo Cutter bender	1250mm	17kgs	16	N/A	N/A	SCBE-16	2	9318428101454





# END CUTTING NIPPERS

ORIGINAL **Will**



Introducing our new range of Nips!. Made in Germany from the highest -grade materials, for soft and hard wire, durable joint and precision cutting edges for twisting & cutting of binding wire.



## Nips

Code	Description	Length	Weight	Box Qty	Soft Wire	Medium Wire	Hard Wire	Barcode
104/200	End Cutting Nipper	200mm	175g	12	3.5	2.5	1.5	4007883106016
172/280	End Cutting Nipper	280mm	440g	12	3.5	2.2	1.3	4007883033428



# FORMWORK ACCESORIES



### RFBA35

Slab Edge Rebate Form Bracket manufactured to make the task of forming the 150mm brick rebate on house floor slabs with ease. The bracket is adjustable to suit 35mm to 50mm timber (pre-set at 35mm).

### RFB-50

Slab Edge Fixed Rebate Form Bracket manufactured to make the task of forming the 150mm brickwork rebate on house floor slabs with ease.

### RFBA8-24

Slab Edge Adjustable Rebate Form Bracket manufactured to make the task of forming brickwork rebates on house floor slabs with ease. Adjusts between a 110mm, 150mm and a 200mm rebate.

### KGB

Kerb Bow formed from 30mm X 10mm steel bar and shaped to form up 150mm splayed kerb using 50mm thick timber.

### KGP-2

Kerb Plate cut to shape from steel plate to form 150mm kerb and used in conjunction with kerb bow. If 150mm straight kerb is required, the plate can be placed to form it.

### MFBB

Used to bend single lengths of rebar quickly and easily. Made from high strength steel and zinc plated for protection. 12mm maximum bar diameter

#### Formwork

Code	Description	Pack Qty	Barcode
RFB-50	150 Rebate Bracket	10	9318428101744
RFBA35	150 Rebate Bracket (LAM/TIM) - Adjustable form board	10	9318428101805
RFBA8-24	Adjustable Rebate Bracket	10	9318428798753
KGB	Kerb & Gutter Bow	10	9318428310108
KGP-2	7" K&G Plate	10	9318428310207
MFBB	Starter Bar Bender	1	9318428112450



KGB



KGP-2



RFB-50

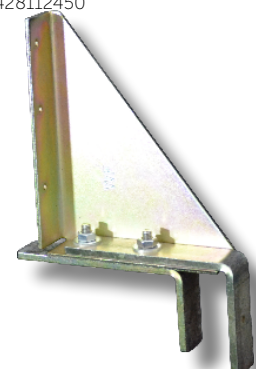

RFBA35



RFBA8-24



MFBB





**A.G PULIE**

**GLADIATOR**

**SECTION 6**





eltDown.org

GMC

ORCARGONET.COM

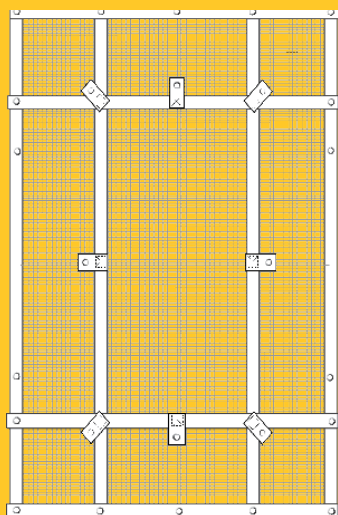

AS/NZS 4380

## Small Gladiator Mesh Net - SMT-300

The most cost effective net in the range. Has complete mesh coverage to secure small items safely. Perfect for covering garden materials or rubbish in a small trailer or ute.

Size	Min Tray Size	Mesh Coverage	Dimensions	Eyelets	Straps	Stock Code	Box Qty	Weight
Small	1.03 x 0.64m	1.80 x 1.40m	1.80 x 1.40m	26	4	SMT-300	8	3.9kg

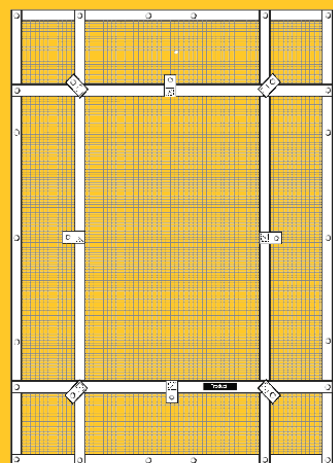

AS/NZS 4380

## Medium Gladiator Mesh Net - MMT-300

Securing the camping gear in the rear of your dual cab or box trailer is made easy with the MMT net. Light weight and easy to use, making your loads safe.

Size	Min Tray Size	Mesh Coverage	Dimensions	Eyelets	Straps	Stock Code	Box Qty	Weight
Medium	1.60 x 1.25m	2.46 x 2.05m	2.46 x 2.05m	30	4	MMT-300	6	5kg

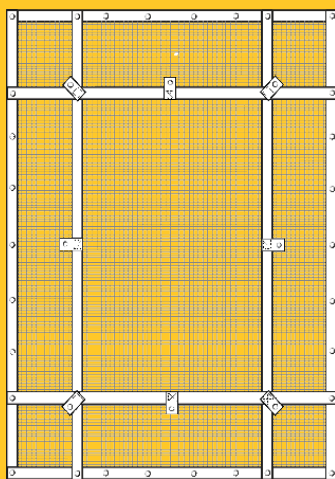

AS/NZS 4380

## Large Gladiator Mesh Net - LMT-300

The LMT is for large trailers and tray back utes, perfect for covering boxes and light loads. With the full mesh coverage, even that load of mulch can be secured.

Size	Min Tray Size	Mesh Coverage	Dimensions	Eyelets	Straps	Stock Code	Box Qty	Weight
Large	2.20 x 1.80m	3.00 x 2.61m	3.00 x 2.61m	36	4	LMT-300	4	6.5kg





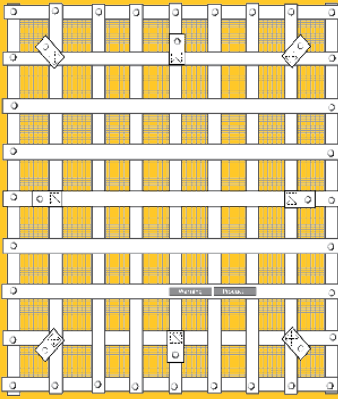

▪ Patent No.  
2012236912

## Small Gladiator Roof Net - SRN-300

The car is stacked with the kids and the dog and the roof is loaded, the SRN will safely secure your load to your roof cage to ensure all your gear gets there safely with you.



Size	Min Tray Size	Mesh Coverage	Dimensions	Eyelets	Straps	Stock Code	Box Qty	Weight
Small	0.80 x 0.80m	1.58 x 1.58m	8 x 1.58m	40	4	SRN-300	N/A	4.75kg

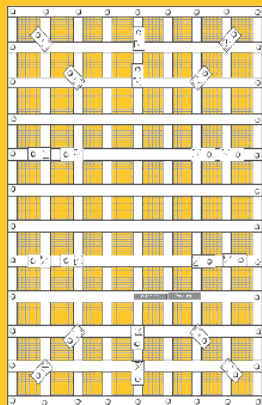

▪ Patent No.  
2012236912

## Medium Gladiator Roof Net - MRN-300

The MRN is not only designed for larger 4WD roof cages, it can also be used to secure larger loads on utes and trailers where the 1000kg SWL and full mesh coverage is required.



Size	Min Tray Size	Mesh Coverage	Dimensions	Eyelets	Straps	Stock Code	Box Qty	Weight
Medium	1.40 x 0.80m	2.18m x 1.58m	2.18 x 1.58m	58	4	MRN-300	6	5.7kg

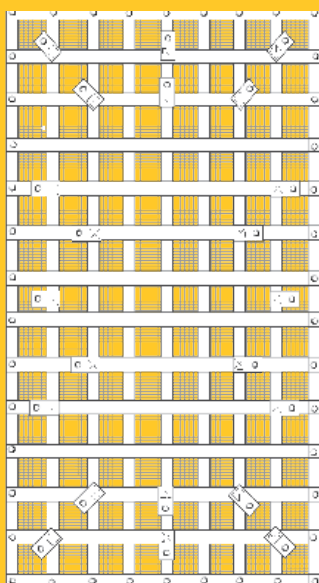
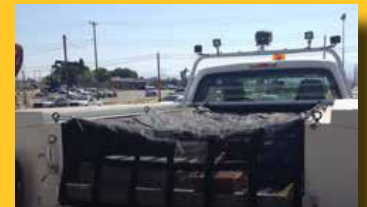

▪ Patent No.  
2012236912

## Large Gladiator Roof Net - LRN-300

The LRN can be used to keep your rods and tackle in your boat whilst securing it to the trailer or securing loads in large trailers and tray back utes. It has also been used to secure loads in the aviation industry.



Size	Min Tray Size	Mesh Coverage	Dimensions	Eyelets	Straps	Stock Code	Box Qty	Weight
Large	1.80 x 0.80m	2.58 x 1.58m	2.58 x 1.58m	64	6	LRN-300	4	7.5kg







# Gladiator

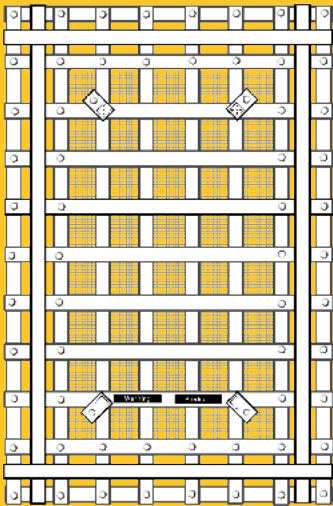

## Small Gladiator Cargo Net - SGN-300

Used for securing small loads in trailers, utes and cars. Perfect for securing loads in the back of station wagons and 4WDs.



Size	Minimum Tray Size	Mesh Coverage	Dimensions	Eyelets	Straps	Stock Code	Box Qty	Weight
Small	1.03 x 0.64m	1.43 x 1.04m	1.80 x 1.40m	46	4	SGN-300	8	4.6kg



Patent No. 2012236912  
AS/NZS 4380

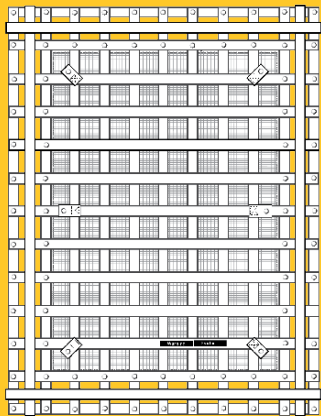

## Medium Gladiator Cargo Net - MGN-300

The medium net was designed with small tray back utes and trailers up to 1.8m in mind. The smaller net makes securing loads on your own easier.



Size	Min Tray Size	Mesh Coverage	Dimensions	Eyelets	Straps	Stock Code	Box Qty	Weight
Medium	1.60 x 1.25m	2.00 x 1.65m	2.46 x 2.05m	86	4	MGN-300	5	6.4kg



Patent No. 2012236912  
AS/NZS 4380

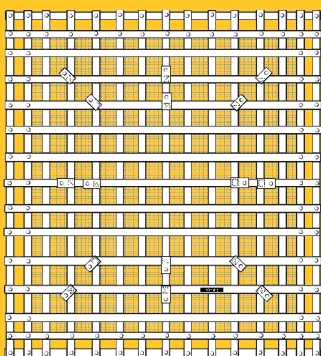

## Dual Cab Gladiator Cargo Net - DCN-300

Dual Cab utes are very popular with tradies and weekend adventurers. This net was made square to safely secure loads in the back of dual cab utes without excessive overhang.



Size	Min Tray Size	Mesh Coverage	Dimensions	Eyelets	Straps	Stock Code	Box Qty	Weight
Dual Cab	1.62 x 1.62m	2.23 x 2.23m	2.43 x 2.43m	112	4	DCN-300	5	8.2kg



Patent No. 2012236912  
AS/NZS 4380

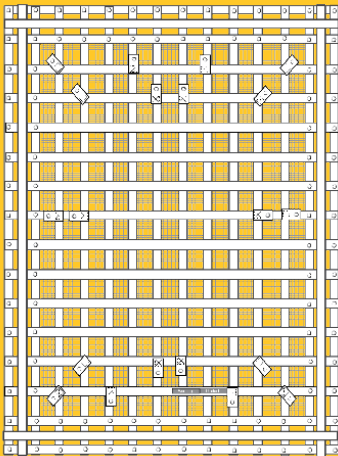

Patent No. 2012236912  
AS/NZS 4380

## Large Gladiator Cargo Net - LGN-300

The most popular design suitable for tray back utes, small trucks and large trailers. The LGN is used to secure a wide variety of loads big and small.



Size	Min Tray Size	Mesh Coverage	Dimensions	Eyelets	Straps	Stock Code	Box Qty	Weight
Large	1.80 x 1.40m	2.60 x 2.22m	3.00 x 2.61m	114	6	LGN-300	4	8.6kg

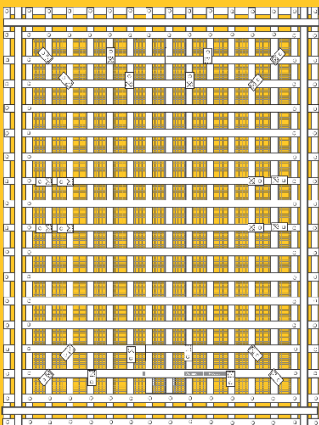

Patent No. 2012236912  
AS/NZS 4380

## XL Gladiator Cargo Net - XGN-300

The XL net is designed for medium sized tray back trucks. Multiple securement points and 8 straps makes it a flexible net to secure your load.



Size	Min Tray Size	Mesh Coverage	Dimensions	Eyelets	Straps	Stock Code	Box Qty	Weight
X Large	1.280 x 1.80m	3.20 x 2.60m	3.60 x 3.00m	136	8	XGN-300	3	11kg

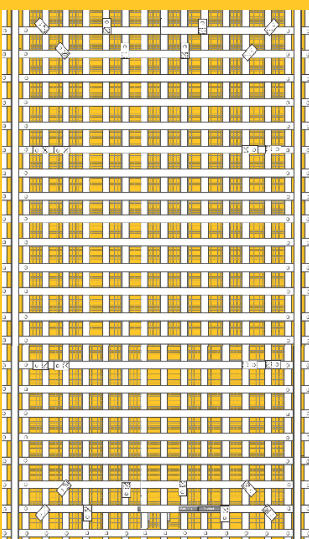

Patent No. 2012236912  
AS/NZS 4380

## XXL Gladiator Cargo Net - XXG-300

Playing with the big toys? The XXL cargo net will cover almost any load with nearly 20m<sup>2</sup> of coverage. Designed with larger trucks in mind, it comes with 8 x 600kg cam lock straps.



Size	Min Tray Size	Mesh Coverage	Dimensions	Eyelets	Straps	Stock Code	Box Qty	Weight
XX Large	4.43 x 2.07m	5.21 x 2.76m	5.60 x 3.16m	180	8	XXG-300	2	18.2kg







# WATERPROOF CARGO NETS



SGW-100



MGW-100



LGW-100

## Introducing the new Heavy-Duty Waterproof Gladiator Cargo Net!

Featuring all the same ruggedness you expect from our classic Gladiator Net! Made with heavy-duty 18 gauge vinyl, this net will lock down your cargo and keep it safe from the elements- and of course safely secured.

The Waterproof Cargo Net is built from UV treated, weatherproofed, heavy-duty 1.5" webbing with triple-layered reinforced edges atop 18 gauge vinyl. Additionally, multiple grommet attachment points around the perimeter allow for:

- Larger sizes to be naturally made smaller
- Tighter angles for odd loads
- Secures at multiple points

Code	Mesh Coverage	Weight	Barcode
SGW-100	1.8m x 1.4m	4.6kg	9318428112672
MGW-100	2.4m x 2m	6.4kg	9318428112498
LGW-100	3m x 2.6m	8.6kg	9318428112689

Every cargo net comes with four **hardware straps** and a **heavy duty storage bag**. The hardware hooks are rubber coated to protect your vehicle. 1.5" inch thick straps which extend from 9" in - 3' ft.

**INCLUDED** 4x Straps & HD Storage Bag







# NARROW TRAY

## CARGO NETS

### GLADIATOR TRAY NETS

Made to fit cargo storage trays on service trucks and the vacant space on ute trays with tool boxes. The Tray net comes in three different lengths. Made from the same superior quality materials as the classic Gladiator cargo nets, with edge to edge mesh design.

Code	Mesh Coverage	Straps	Eyelets	Barcode
SGT-100	0.6 x 1.65m	4	14	9318428114898
MGT-100	0.6 x 2.74m	4	22	856611000287
LGT-100	0.6 x 3.33m	4	24	9318428104158

SGT-100



MGT-100

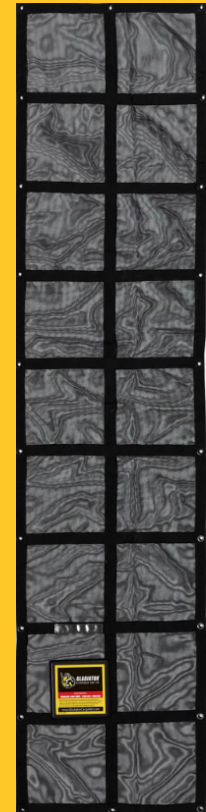

## HARDWARE ACCESSORIES

### Replacement Straps

Replacement straps are available with 3 different styles of hook fittings. S-Hook, Hook & Keeper, and N-Hook. S-Hook style straps are available in lengths of 700mm and 1000mm

Code	Hook Style	Strap Length	Quantity per pack	Barcode
ASH-300	S-Hook	1000mm	2	856611000607
ASH-370	S-Hook	700mm	2	856611000614
AHK-300	Hook & Keeper	700mm	2	856611000621
ADH-300	N-Hook	700mm	2	856611000591



HOOK & KEEPER



N-HOOK



S-HOOK



### Replacement Carabiner

Replacement snap link carabiner. These are the same carabiners used in all the Gladiator cargo net hardware. Made from zinc plated steel. Available in a 10pc set

WLL: 600kgs

Code	Description	Size	Quantity per pack	Barcode
SL311	Carabiner pack	90mm	10	9318428105940



SL311

# INDEX

## A

Adhesive Spreader pg. 35

## B

Blades pg. 98-99

### **Bolt cutters**

MCC pg. 123

Masterfinish pg. 122

Brickies Trowels pg. 27

Brick Brushes pg. 28,50

Brick Tools pg. 46-50

Brick Trolleys pg. 63

Bricksaws pg. 87-88

Brooms pg. 18-19

Bullfloats pg. 14-15

Blocksaw pg. 89

Builders Line pg. 53

Buckets pg. 51

Bucket pump pg. 38

## C

Cargo Nets pg. 128-133

Cement Mixer pg. 102-110

Channel Floats pg. 15-16

Compactors pg. 111-113  
116-117

Concrete Remover pg. 121

Coving Tools pg. 8, 21

Cutter/Bender pg.122-123

## D

Drive Units pg. 68-69

Spares pg. 100

## E

### **Edgers**

Concrete pg. 9

Bevel pg. 10

Excel pg. 29

Plasterers Nosing pg. 28

Safety Step pg. 11

Extension Shafts pg. 78

## F

Featheredge pg. 34

### **Floats**

Channel pg. 15-16

Excel pg. 29

Hooks pg. 21

Magnesium pg. 11

Plastic pg. 12

Sponge pg. 28

Steel pg. 7

Wood pg. 7

Formwork pg. 125

Fresno pg. 13

## G

Gauge Rods pg. 52

Gloves pg. 37

Glove Clips pg. 21

Grinding pg. 79, 84

Groovers pg. 14, 29

Grout Scoop pg. 50

Gunite Shoes pg. 35

## H

Hand Trowels pg. 6, 10

HandyVibes pg. 72-73, 76

Spares pg. 100

Hawks pg. 28

## I

Ideal Reels pg. 120

## J

### **Jointers**

"V" pg. 10

Excel pg. 29

## K

Kerbing Tools pg. 20, 125

### **Kneeling**

Boards pg. 26

Pads pg. 36

Sliders pg. 35

Knucklehead pg. 15

## L

Line Pins pg. 50

Line Blocks pg. 53

Lay Flat Hose pg. 78

## M

Machinery spares pg. 100-101

Margin Tools pg. 8

Masonry Brush pg. 28, 50

Mixer Paddles pg. 35

Motor Covers pg. 101

Mesh Roller pg. 17

# N

Nippers pg. 124  
Nosing tools pg. 10, 28

# O

# P

Pans pg. 101

## Pins

Dutch pg. 50

Line pg. 50

Pointed Trowels pg. 06

## Poles

Accessories pg. 33

Kraft pg. 15

Masterfinish pg. 33-34

Post Removers pg. 75

Post Driver pg. 74

Portable Generator pg. 80

Pressure Washer pg. 81-83

Profile Poles pg. 52

Pry Bar pg. 35

Pumping pg. 77

# Q

# R

## Rakes

Concrete pg. 25

Landscape pg. 24

Nail pg. 24

Smoother pg. 17

Thinkness Gauge pg. 17

Rammers pg. 114-115

Reo Tools pg. 120-123

Roller Tamper pg. 17

Rubbing Bricks pg. 35

Rebar Bender pg. 121

# S

Scoop pg. 50,53

Scrapers pg. 22

**Screeds** pg. 31-32

Bump Cutter pg. 16

Check pg. 16

Twin Beam pg. 86

Vibrating pg. 85

Shifting Tools pg. 23-24

Sliders pg. 35

Splatter Gun pg. 28

Sprayers pg. 38-43

Square Trowels pg. 6

Squeegee pg. 17

Standing Bracket pg. 13

Steel Floats pg. 7

Step Tool pg. 10-11

Straight Edges pg. 30

# T

## Tape Measures

Brick pg. 51

Tie Wire Twister pg. 121

Tilt Brackets pg. 15

## Trowels

Bricks pg. 27

Coving pg. 8, 21

Fresno pg. 13

Gauging pg. 27

Marble Sheen pg. 10

Pointed pg. 6

Pool pg. 21

Square pg. 6

Walking pg. 12

## Trowel Machines

Pole pg. 91

Edging pg. 92-93

Walk Behind pg. 90, 94-96

Ride on pg. 97

Blades pg. 98-99

Pans pg. 101

Trestles pg. 48

Trolleys pg. 64

# U

# V

Vibration pg. 70-73, 76

Vibrating Screed pg. 85-86

Vibrating Shafts pg. 70-71

# W

Walking Tools pg. 12-15  
21,29

Walking Trowels pg. 12

Wheelbarrows pg. 56-63

Wheels pg. 65

Wire Reels pg. 120

Wire pg. 120

Wire Twister pg. 121

Wood Floats pg. 7

# X

# Y

# Z



# A.G.PULIE

**MASTERFINISH**

*Easymix*

*Cemtool*



**HandyVIBE**

**IDEAL**

ORIGINAL  
**W:III**

**POSTJAK**  
POST & PICKET PULLER

**MCC**

**Starrett®**

**3MPS**

## WAREHOUSES & OFFICES LOCATIONS AUSTRALIA WIDE

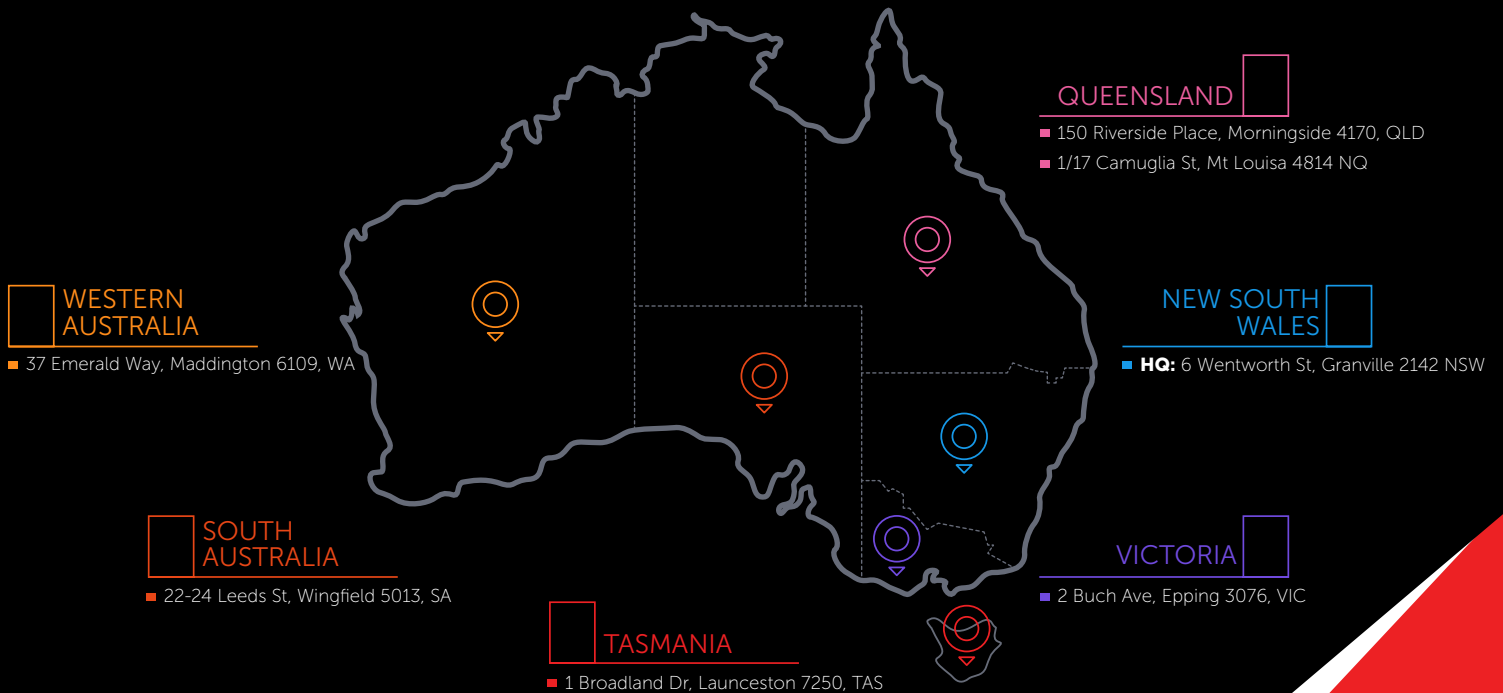

**A.G. PULIE PTY LTD**  
6 Wentworth St, Clyde, NSW 2142

**02 9637 9011**  
[sales@masterfinish.com.au](mailto:sales@masterfinish.com.au)  
[www.agpulie.com.au](http://www.agpulie.com.au)